

# RADIO-CRAFT

HUGO GERNSBACK, Editor



**MILITARY  
RADIO JOBS!**  
See Page 458



**NEW KLYSTRON**



**FANTASIA**



**SPARKO**

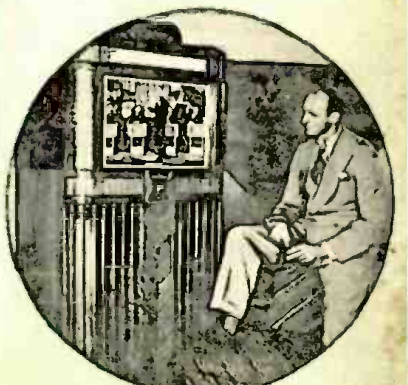

**SOUNDIES**

**FEB. 25c** RADIO'S GREATEST MAGAZINE  
CANADA 30c  
ELECTRIC EYE BURGLAR ALARM • DIATHERMY INTERFERENCE  
MICROPHONE TECHNIQUE • TESTER FOR SERVICING SUPERS.

# High Fidelity FM/AM TUNER

## MODEL S-31

Hallicrafters High Fidelity Tuner for Frequency Modulation and Amplitude Modulated Reception.



Now you can have "FM-AM" reception by a turn of the bandswitch with the Model S-31 Hallicrafters commercial FM-AM Tuner. Covering the broadcast (AM) band and the 40-51mc. high frequency (FM) band. The Tuner combines the FM and AM circuits in one chassis with either instantly available at the turn of the bandswitch.

**SPECIFICATIONS** — 9 tubes — Frequency range band one, 550 to 1600 kc.: band two, 40 to 51mc.— Power output 130 milliwatts undistorted—Output impedances 500 to 5,000 ohms—Power consumption 120 watts — Controls: bandswitch, radiophone switch, main tuning, audio gain, tone control, "S" meter adjustment, phone jack. Operating from 115-125 volts, 60 cycles AC. Panel dimensions 19"x8 3/4"  
—Price \$69.50

## MODEL S-22-R

Specifically designed for service in the range 16.2 to 2150 meters (18.5mc. to 110kc.). Efficient mechanical bandspread with separate dial provides easy logging. Frequency range extended down to 110kc. Built for 110 volt AC-DC operation. Also may be operated from 6 volt battery supply with addition of converter. (Model S-22-R) Complete with tubes and speaker. Price \$64.50.

*We carry the complete Hallicrafters line including the famous new Model SX-28.*



# RADIO ELECTRIC SERVICE CO., INC.

Northwest Corner 7th and Arch Sts., Philadelphia, Pa.

BRANCHES IN

No. Philadelphia • W. Philadelphia • Camden • Wilmington • Allentown • Easton



J. E. Smith, Pres.  
National Radio  
Institute  
Est. 25 Years

# I WILL TRAIN YOU TO START A SPARE TIME OR FULL TIME RADIO SERVICE BUSINESS WITHOUT CAPITAL

I Trained  
These  
Men

I Trained  
These  
Men

**N. R. I. MEN  
WORK IN THESE  
BRANCHES, TOO**

**These Men Have  
SPARE TIME BUSINESSES**

**JOHN JERRY**  
1529 Arapahoe St., Room 17, Denver, Colo.  
"I repaired some Radio sets when I was on my tenth lesson. I really don't see how you can give so much for such a small amount of money. I made \$800 in a year and a half, and I have made an average of \$10 to \$20 a week—just spare time."

**WM. E. RUPP**  
611 Green Street, Bridgeport, Pa.  
"I am now making from \$10 to \$25 a week in spare time while still holding my regular job as a machinist. I owe my success to N. R. I."

**JOHN WASHKO**  
87 New Cranberry, Hazleton, Penna.  
"I am doing spare time Radio work, and I am averaging from \$700 to \$850 a year. Those extra dollars mean so much—the difference between just getting by and living comfortably."

**These Men Have  
FULL TIME BUSINESSES**

**ARLIE J. FROEHRNER**  
300 W. Texas Ave., Goose Creek, Texas  
"For the last two years I have been in business for myself making between \$200 to \$300 a month. Business has steadily increased. I have N. R. I. to thank for my start in this field."

**KARL KELLY**  
409 W. Calhoun St., Magnolia, Ark.  
"Before taking your Course I earned about 17¢ cents an hour as a truck driver. When I had completed 20 lessons I started service work. During the last two years I have made about \$3,000 in Radio. I now own my own shop."

**H. W. SPANGLER**  
126 1/2 S. Gay St., Knoxville, Tenn.  
"I am making between \$50 and \$80 a week after all expenses are paid, and I am getting all the Radio work I can take care of, thanks to N. R. I."



(Above) Broadcasting Stations employ operators, installers, maintenance men and Radio Technicians in other capacities and pay well.



(Above) Radio Jobbers and Dealers employ installers and servicemen at good pay.



(Above) Loud Speaker System is another field for Radio Technicians.



(Left) Police, Aviation and Commercial Radio are newer fields for which we give the required knowledge of Radio.

**YOU GET THIS  
PROFESSIONAL SERVICING  
INSTRUMENT**

This instrument makes practically any work you will be called upon to make in both spare time and full time jobs. It can be used on the test bench or carried along when out on calls. It measures A.C. and D.C. Voltages and currents; tests resistances; has a multi-hand any set for aligning any set or for new. You get this instrument to keep as part of your N. R. I. Course.

**SAMPLE LESSON FREE**

I want to prove our Course gives practical, money-making information. That it is easy to understand—what you need to master Radio. My sample lesson text, "Radio Receiver Troubles—Their Cause and Remedy," covers a long list of Radio receiver troubles in A.C., D.C., battery, universal, auto, T.R.F., superheterodyne, all-wave, and other types of sets. And a cross reference system gives you the remedy to cause and a quick way to locate and remedy these set troubles. A special section is devoted to receiver check-up, alignment, balancing, neutralizing, testing.

**Mail Now**

You can get this lesson Free by mailing the coupon.

The world-wide use of Radio has made many opportunities to have a spare time or full time Radio service business of your own. Over 28,000,000 homes have over 40,000,000 Radios. There are more Radios than telephones. Every year millions of these Radios go out of date and are replaced. There's an opportunity to earn good commissions selling new sets. Millions more need new tubes, servicing. I will train you at home in your spare time to sell, install, fix all types of Radios; to start your own Radio service business and build it up on money you make in your spare time while learning. You don't have to give up your present job, or spend a lot of money going away to school to become a Radio Technician.

**MANY MAKE \$5 TO \$10 A WEEK EXTRA  
IN SPARE TIME WHILE LEARNING**

I start sending Extra Money Job Sheets the day a student enrolls—that shows how to do Radio repair jobs. Throughout the Course I send additional plans and directions for doing increasingly complicated, better paying jobs. That's why many students make \$5 to \$10 a week extra in spare time; why many start building their own Radio service businesses while learning.

**I TRAIN YOU FOR GOOD JOBS TOO  
MANY PAY \$30, \$40, \$50 A WEEK**

Anyone can tune a Radio set, but few can service one. That's why many qualified Radio Technicians make such good money installing, fixing, selling home and auto Radio Sets, operating and maintaining Broadcast, Police, Aviation, Commercial Radio stations; selling, installing, servicing Loudspeaker systems. That's why many open their own Radio

sales and repair businesses and make \$30, \$40, \$50 a week. Why others hold their regular jobs and make \$5 to \$10 a week extra fixing Radios in spare time.

**HOW I GIVE YOU PRACTICAL EXPERIENCE**

I send you special Radio equipment; show you how to conduct experiments, build circuits illustrating important principles used in modern Radio receivers, broadcast stations and loudspeaker installations. You work out, with your own hands, many of the principles you study in our lesson texts. **YOU ALSO GET A PROFESSIONAL ALL-WAVE, ALL-PURPOSE SET SERVICING INSTRUMENT.** See the left-hand column on this page.

**YOU LEARN TELEVISION, "F-M", ELECTRONICS**

The N. R. I. Course is up-to-date. You are taught how to install, adjust, service Television receivers and antennas. You learn about Frequency Modulation transmitters and receivers; you learn the principles of electronic control equipment, such as photoelectric counters, safety devices, electric eye burglar alarms, etc.

**FIND OUT HOW I TRAIN YOU AT HOME**

Act Today. Mail the coupon now and I will send my book, "Rich Rewards in Radio," and a Sample Lesson free. Find out what Radio offers; what opportunities are coming in Television; read the details of my Course in Radio and Television; read more than 100 letters from men I have trained; what they are doing, earning. Read my Money Back Agreement. **MAIL COUPON BELOW** in an envelope or paste on a postcard—NOW.

**J. E. SMITH, President**  
National Radio Institute, Dept. 18X  
Washington, D. C.

**GOOD FOR BOTH 64 PAGE BOOK  
SAMPLE LESSON FREE**



**J. E. SMITH, President, National Radio Institute**  
Dept. 18X, Washington, D. C.

Without obligating me, mail your Sample Lesson and 64-page book FREE. I am particularly interested in the branch of Radio checked below. (No salesman will call. Write plainly.)

- Radio Service Business of My Own
- Spare Time Radio Repair Work
- Service Technician for Retail Stores
- Broadcasting Station Operator (if you have not decided which branch you prefer—mail coupon now, for information to help you decide.)
- Loudspeaker Systems, Installations and Service
- Auto Radio Installation and Service
- Television
- All-around Servicing Technician

Name .....

Address .....

City .....

State .....

14X1

# RADIO-CRAFT

HUGO GERNSBACK, *Editor-in-Chief*

N. H. LESSEM  
*Associate Editor*

THOS. D. PENTZ  
*Art Director*

R. D. WASHBURNE, *Managing Editor*

*In the*  
**NEXT ISSUE!**

- Fluorescent Lighting, Part II
- Modernize Your Old Testers
- Improvements in F.M. Sets
- The ABC of Tube Oscillators
- Design of a Multi-Range Tester

## Contents FEBRUARY, 1941 Issue

VOLUME XII -- NUMBER 8

|                                     |                    |
|-------------------------------------|--------------------|
| Mailbag .....                       | 451                |
| Editorial: Radio Men—Wake Up! ..... | Hugo Gernsback 455 |
| The Radio Month in Review .....     | 456                |

### RADIO DEFENSE

|   |     |
|---|-----|
| Opportunities in Military Radio (Cover Feature)<br>Staff Sgt. Chas. J. Schauers | 458 |
| Radio Blackout on the High Seas ... Bernard Clive McCorry                       | 461 |
| Your Radio Training and the Defense Program ... J. E. Smith                     | 463 |

### SERVICING

|   |     |
|---|-----|
| New Circuits in Modern Radio Receivers—No. 41<br>F. L. Sprayberry | 464 |
|---|-----|

#### RADIO SERVICE DATA SHEETS:

|   |          |
|---|----------|
| No. 300 Sentinel Model 227-P Camera-Type Battery-Portable | 466      |
| No. 301 RCA Victor Model BT-42 Battery Receiver           | 476      |
| Refinishing Radio Cabinets ... Charles R. Leutz           | 467      |
| Radio Set to Test Radio Sets ... Harold Davis             | 468      |
| Visual Dynamic Servicing—Part II ... B. O. Burlingame     | 470      |
| Operating Notes   | 477, 500 |

|  |     |
|--|-----|
| Circuit Features of the Latest Ultra-H.F. "DX" F.M.-A.M. Receiver ... S. Gordon Taylor | 483 |
| "Electric Eye" Burglar Alarm ... L. M. Dezettel  | 501 |

### F.M.

|  |     |
|--|-----|
| A New A.F.-Drift Correcting, Signal-Balancing, Direct-Coupled F.M. 24-Watt Audio Amplifier—Part III ... A. C. Shaney | 480 |
| Circuit Features of the Latest Ultra-H.F. "DX" F.M.-A.M. Receiver  | 483 |

### SOUND

|  |     |
|--|-----|
| A New A.F.-Drift Correcting, Signal-Balancing, Direct-Coupled F.M. 24-Watt Audio Amplifier—Part III ... A. C. Shaney | 480 |
| Smallest Radio Tubes ... R. D. Washburne   | 499 |
| Sound Engineering—No. 14 ... Conducted by A. C. Shaney   | 486 |
| Modern Microphone Technique—Part I, The Microphone<br>L. Fletcher and H. S. Manney                                   | 489 |
| "Fantasia" Introduces "Fantasound"   | 495 |

### ELECTRONICS

|   |     |
|---|-----|
| Smallest Radio Tubes! ... R. D. Washburne   | 499 |
| Servicemen!—Install Them for Greater Profits—"Electric Eye" Burglar Alarms ... L. M. Dezettel | 501 |

### RADIO DEVELOPMENTS

|   |     |
|---|-----|
| Introducing "Soundies" .....  | 503 |
| The "Klystron" Tube—Does It Herald Radio Transmission of Power? ..... | 503 |

### DEPARTMENTS, ETC.

|   |          |
|---|----------|
| RADIO SERVICE DATA SHEETS (See Servicing) .....             | 466, 476 |
| The Radio Month in Review .....                             | 456      |
| New Circuits in Modern Radio Receivers ... F. L. Sprayberry | 464      |
| Sound Engineering—No. 14 ... Conducted by A. C. Shaney      | 486      |
| Latest Radio Apparatus .....                                | 505      |
| Classified Radio Directory .....                            | 507      |
| Shop Notes—Kinks—Circuits .....                             | 511      |
| Book Reviews .....  | 512      |



Published by Radcraft Publications, Inc. Publication office: 29 Worthington Street, Springfield, Mass. Editorial and Advertising Offices: 20 Vesey Street, New York City; Chicago Advertising Office: RADIO-CRAFT, 520 North Michigan Avenue, Chicago, Ill.

RADIO-CRAFT is published monthly, on the first of the month preceding that of date; subscription price is \$2.50 per year in U. S. (In foreign countries, 75c additional per year to cover postage; Canada, 50c additional.) Entered at the post office at Springfield as second-class matter under the act of March 3, 1879.



#### Foreign Agents:

London—Gorringe's American News Agency, 9A Green St., Leicester Square, W. C. 2, England.  
Paris—Messageries Dawson, 4 Rue Faubourg, Poissonniere, France.  
Melbourne—McGill's Agency, 179 Elizabeth St., Australia.  
Dunedin—James Johnston, Ltd., New Zealand.



Text and illustrations of this magazine are copyright and must not be reproduced without permission of the copyright owners.



Copyright 1941 Radcraft Publications, Inc.

REGARDING HEARING-AIDS

Dear Editor:

I am near-deaf, and yet have been repairing radio sets some 20 years, so your articles on hearing-aids are of great interest. However I think that really near-deaf people should be warned beforehand that these aids frequently do not have nearly enough volume to be of any real service to them.

I have constructed both "The Latest Miniature Hearing-Aid Amplifier" (May, 1940, *Radio-Craft*) and "Miniature Tube Audio Amplifier" (Oct. 1940). They are all right for someone just slightly hard-of-hearing and who is a good lip reader. As to H. G. Cisin in his article of Oct. 1940, I quote: "The subject of the test was a person who depends upon lip reading, due to the inability of ordinary hearing-aids to give relief. Without the instrument, one could get behind this near-deaf person and shout as loud, as possible without being heard. With this amplifier, however, the hard-of-hearing person was able to hear every word spoken behind his back." He did it with mirrors, Mr. Cisin. It's an old one, but card sharks still catch suckers with the looking glass on the wall.

Now, suppose there is a near-deaf person, unable to hear shouting behind his back (without a mirror). The best hearing-aid is a pencil and a pad of paper. The next best that I know of was published in *Radio-Craft*, Vol. 9, No. 10 (April, '38): "A Handy P.A. Amplifier". Put this in a cigar box; use a carbon mike (a crystal hasn't got it; I use a cheap \$1.76 lapel mike mounted on the end of BX); get a good single ear-phone, magnetic (again crystal hasn't got it); couple it via a transformer, and you have a hearing device, not an aid. Somebody design something like it, with not over 4 tubes and battery operated, and they have done the near-deaf a great service.

I take violent exception to Author's Note, page 676 "R.C." of May, '40: "This discussion is not intended to encourage radio dealers, Servicemen, or technicians to set themselves up as hearing-aid specialists—etc". Medical ethics I presume. That seems to be 90% of medicine, and if the above-mentioned radio dealers, etc., are not hearing specialists, what are they? The public has had too damn much ethics. "It would not be ethical, if I didn't charge you \$25 for this consultation," thinks the doctor. Listen, Sir, for years you M.D.s have sold us near-deaf (A near-deaf person is one who can't hear well with the type instrument the Doctor sells.) tin ears, and all we ever got was less to eat, while we paid \$100 to \$140 for a disguised telephone mike and an ear-piece. Let the near-deaf stay away from the "high gain" name, "otologist", unless he will guarantee results or no money, like we radio men have to do. If every near-deaf person in the country went to his radio Serviceman tomorrow morning and demanded he make him a hearing device—not an aid or an aid to aid the aid—90 days from now it would be possible for all to hear and \$25 would buy the de luxe gold-plated model.

Let's go fellows, we made radio sets—let's enable the near-deaf to hear! Remember, hearing is the objective, not size. Too much emphasis has been put on size. Why?, because the customer thinks he can hide it and no one will know he is hard-of-hearing? "Nerts!"

EARL RUSSELL,  
Celfax, Ill.

P.S. How do I fix radio sets, if I am near-deaf? Why, I use my "Handy P.A. Amplifier" as described in *Radio-Craft*, April 1938! Cost all of \$10, too.

# MAKE MONEY IN RADIO

Get Started Now!

Full or Spare Time  
—without leaving home

These Ghirardi  
Books Will  
Help You

—at unbelievably  
low cost!



ALFRED A. GHIRARDI, the author of these books, is one of the foremost writers of practical radio texts and is an outstanding authority on radio instruction. His wide experience as a radio engineer, radio instructor, radio magazine editor and technical consultant to many prominent radio manufacturing firms and servicing organizations has built for him an unusually wide background of radio knowledge that is reflected in these three books. Every one of them is acclaimed as being outstandingly superior to anything in its field. They have earned for themselves an enviable reputation for thoroughness, and the ability to make every phase of the subject clear and easy to learn for even the merest beginner. That is why they are the favorites of radio beginners, servicemen and experts alike, and are used as the main texts in the basic radio theory and servicing courses of leading radio schools in every English-speaking country in the world. They have had to be "tops" to earn such honors!

## RADIO PHYSICS COURSE

LEARN FUNDAMENTALS  
with This!

Here in one inexpensive volume is a complete Radio Education for you—all the Basic Fundamentals clearly explained and illustrated—right from elements of Electricity and Sound up through the entire field of Radio and Television—the equivalent of a 36-Book Radio Course all condensed into 1 big volume.

YOU LEARN AT HOME!

Ghirardi will train you quickly—right in your own easy chair at home. His explanations are crystal-clear, interesting, easy to understand. And because it's so easy to learn Radio from it, the U. S. Army and Navy and radio schools everywhere use this very same book in their radio training course. No math—no previous training is necessary. Here's a \$50.00 course that you get complete for only \$4. Order your copy NOW—money back if not satisfied.

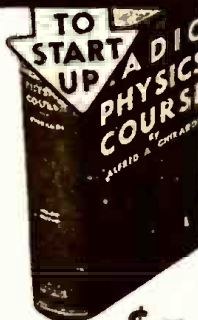

972 PAGES  
508 ILLUS.  
856 REVIEW  
QUESTIONS

## MODERN Radio SERVICING

LEARN SERVICING  
with This!

This inexpensive, big 1300-page book gives you the complete famous Ghirardi training course in practical radio service work. The only book in the world that teaches you everything you need to know right in your own home—easily, and in your spare time.

Theory from A to Z

- Test Equipment—First, a thorough 420-page course in Test Instruments—Theory, Descriptions, Diagrams of all Commercial Instruments. How they Work. Construction Data, etc.
- Trouble-Shooting—Next, all newest short-cut factory methods for Trouble-shooting and Testing all makes of radio sets (and electronic equipment)—explained clearly and step-by-step.
- Repairing—Then how to Align and Adjust receivers; how to Repair or Replace faulty parts. Advanced "Factory" Methods explained fully.
- Business Promotion—How to Manage, Promote and Advertise a radio service shop for greatest profits.

MODERN RADIO SERVICING brings you an illustrated gold mine of servicing knowledge—all based on Practical servicing experience! 720 Self-Examination Review Questions check every step of your study progress. Order yours now—costs you only \$4 to learn radio service work this EASY way! Money back if not satisfied after 5-Day Trial.



1300 PAGES  
708 ILLUS.  
720 REVIEW  
QUESTIONS

## RADIO Troubleshooter's HANDBOOK

SAVE SERVICING  
TIME with This!

Regardless of what radio set you are called upon to repair, this new "Ghirardi" Handbook is guaranteed to save you Time. Check full of factory-checked "bench data" that will speed up every service job you do. This means More Money for you!

518 BIG 8 1/2 x 11 PAGES—134 ILLUS. DRAWINGS, CHARTS, TABLES—Give Vital Information on:  
Time-Saving Trouble Case Histories for 3,313 receivers compiled from actual service records—1 F. Peaks for 15,000 Superhets—Trouble-Shooting Charts—Auto Radio Gear Ratios—Auto Radio Installation, Servicing, Interference Suppression Charts—Servicing Sound Recorders and Intercommunicators—Condenser & Resistor Charts—Grid Bias Resistors—Color Codes—Wire Tables—Coils—Transformers—Formulas—Calculations—Decibel Charts—Tube Charts—Dial Lamps—Ballast Resistors—Filters. Used by thousands of service shops. Order yours—Money back if not satisfied!



518 PAGES  
134 ILLUS.

Books Shipped Postpaid Anywhere

USE THEM 5 DAYS

Send for any or all of these books today. Keep them 5 days to look over at your leisure. Then if not fully satisfied, return them in good condition and we will refund your full purchase price immediately. You can't lose.

FREE CIRCULARS

Send for FREE, descriptive, illustrated circulars SPECIAL MONEY-SAVING \$6.50 FOR BOTH SERVICING BOOKS—IF COMBINATION PURCHASED TOGETHER OFFER

ORDER NOW before prices GO UP!

RADIO & TECHNICAL PUBL. CO.  
45 Astor Pl., New York, Dept. RC21  
Enclosed find payment for, and rush to me postpaid with your 5-Day Money-Back Guarantee:  
 No. 1—MODERN RADIO SERVICING at \$4. (\$4.50 foreign).  
 No. 2—RADIO TROUBLE-SHOOTER'S HANDBOOK at \$3. (\$3.50 foreign).  
 BOTH SERVICING BOOKS at \$6.50 Special Money-Saving Combination Price (\$7 foreign).  
 No. 3—RADIO PHYSICS COURSE at \$4. (\$4.50 foreign).

NAME.....  
ADDRESS.....  
CITY..... STATE.....  
Please send me FREE illustrated literature describing Books  No. 1  No. 2  No. 3.

## RADIO-TELEVISION

Oldest, largest Radio-Television school in West trains you for good pay job. Complete instruction including Radio Construction and Service, Broadcast Operating, Sound, Talking Pictures, Television, Public Address, etc. Flexible plan to meet specific needs of those with or without jobs. Transportation allowed to L.A. Earn room and board while learning. Request Free Catalog.

NATIONAL SCHOOLS, Dept. RC-2  
Los Angeles

## RADIO TECHNOLOGY

RCA Institutes offer an intensive course of high standard embracing all phases of Radio and Television. Practical training with modern equipment at New York and Chicago schools. Also specialized courses in Aviation Communications, Radio Servicing and Commercial Operating. Catalog Dept. RC-41.

RCA INSTITUTES, Inc.  
A Radio Corporation of America Service  
75 Varick St., New York, 1154 Merchandise Mart, Chicago

## RADIO OPERATORS WANTED

The National Defense Program is creating innumerable openings for Commercial Radio Operators—Now is the time to capitalize on your radio training and experience by obtaining a Commercial Radio Operator's License and taking advantage of the many opportunities presented. My recent publication "RADIO OPERATORS' LICENSE GUIDE" has been especially prepared as a Guide for those radio men having the necessary training and experience but who are unaware of the exact requirements for a Commercial Radio Operator's License—Containing over 1,250 questions and answers to the new type examinations. It will enable you to successfully pass the examinations.

Only \$3.00 Postpaid—Send check or Money Order.

WAYNE MILLER  
205 West Wacker Drive  
Chicago, Illinois

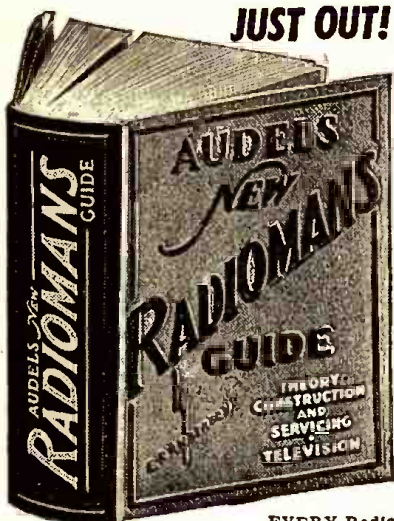

# RADIO

The whole subject of Modern Radio—covering the Basic Principles—Construction & Operation—Service—Repairs—Troubles—All Easily Understood. Over 750 Pages, 400 Illustrations, Parts & Diagrams—LATE TELEVISION DATA—Valuable for REFERENCE AND HOME STUDY.

To get this practical information in handy form for yourself fill in and mail coupon today.

**4 COMPLETE • PAY ONLY \$1 A MO.**

AUDEL Publishers, 49 W. 23rd St., N. Y. Mail AUDELS NEW RADIO MAN'S GUIDE for free examination. If O. K. I will send you \$1 in 7 days; then remit \$1 monthly until price of \$4 is paid. Otherwise, I will return it.

Name \_\_\_\_\_  
 Address \_\_\_\_\_  
 Occupation \_\_\_\_\_  
 Reference \_\_\_\_\_ RCF

**WILL BUY FOR CASH**  
**OLD POSTAGE STAMPS AND COMPLETE COLLECTIONS**

Thousands of dollars lying idle in old postage stamps and collections! Dig yours out and sell at today's top prices. Especially interested in old United States stamps (used or unused) and later issues up to 1930. Write for references, or send stamps for prompt appraisal and offer.

**HARRY P. BRIDGE**  
 1324 Walnut St. Philadelphia, Pa.

**RADIO SERVICE EXPERT**  
**LEARN AT HOME IN SPARE TIME**

Clear, simple, fascinating lessons—practical work with experimental kits—make training easy and fast. Up to date R.T.A. methods, under personal guidance of prominent engineer and educator, highly endorsed by leaders in radio industry. Spare-time profits soon pay for training.

**START NOW**—have your own business or fit yourself for well paid work with radio dealers, in factories, police, marine or television fields. **DON'T DELAY!**

Send AT ONCE for complete information and Big Opportunity **BOOK FREE!**

**RADIO TRAINING ASS'N. OF AMERICA**  
 1559 Devon Ave. Dept. RC-21 Chicago, Ill.

**RADIO COURSES**

Mid-Term Classes Now Starting

- RADIO OPERATING—BROADCASTING
- RADIO SERVICING—practical course
- RADIO AMATEUR CODE ● TELEVISION
- ELECTRONICS—1 yr. day course 2 yrs. eve. Day and Evening Classes. Booklet Upon Request.

**New York Y.M.C.A. Schools**  
 4 W. 64th Street New York City

**Correspondence Courses in RADIO and ELECTRICAL ENGINEERING**

**ELECTRICAL ENGINEERING** Get good grasp of electrical field. Prepare yourself, at Low Cost, for secure future. Modern, simplified, you can understand quickly.

**RADIO ENGINEERING** Extra fine course in radio, publication address, photo-electric work. Trains you to be super-service man, real vacuum tube technician. Exper. kits furnished. Diploma on completion. Tuition, \$25. either course. Deferred payment plan.

**FREE** Get copies of school catalogs, student magazines, complete details. **SEND NOW!**

**LINCOLN ENGINEERING SCHOOL, Box 831-C26, LINCOLN, NEBR.**

## THANKS, WILLARD, FOR YOUR COMMENTS

Dear Editor:  
 Would you like to make some money and increase your circulation? Would you like to enjoy a greater respect and prestige? Then carry out the following instructions and reap your golden harvest.

- (1) The cover should be printed in as simple a design as possible, with a single good photograph spread over it. This is for unity and greatest appeal.
- (2) The editorials by Hugo Gernsback should be discontinued as they are horribly tiresome. The same goes for "letters from the readers". All of this material uses up precious space and makes the magazine harder to read for the reason that fine print is necessary to compress the editorial contents.
- (3) The feature Radio Month in Review should be cut out, and also all reference to foreign methods, such as those used by the English in television work. You editors should do the translation into American forms and not expect us in the trade to do so. You read foreign data and then build American apparatus which you then describe.
- (4) Keep Sprayberry.
- (5) Concentrate on terse, highly-accurate material. Ban verbosity and questionable articles.
- (6) Make your magazine definitely committed to the policy of general coverage. Universal appeal is then a matter of course, and greater circulation assured. This attracts paying advertisers, allowing you to pay for material of better quality. The snowball soon gathers momentum going downhill and becomes a huge white boulder, with the bank balance going skyhigh.
- (7) Keep your Operating Notes more brief and pointed, using only the best available material.
- (8) Throw out the Hints and Kinks, and do not go back to running the Radio Trade Digest.
- (9) Aim your arrow at the intelligent section of the radio public, not the dopey Servicemen. Concentrate on articles for the men who are intelligent Servicemen, not guys who write to an editor and hope for an answer by mail on how to fix a radio.
- (10) Include in your program the radio amateur, the experimenter and the beginner. **REMEMBER: QUALITY, NOT QUANTITY!**

WILLARD MOODY,  
 New York, N. Y.

## TUBE AND SET TESTER

Dear Editor:  
 Thought you might be interested in the

pictures enclosed. Ran across them the other day when clearing up things. Most of my bench equipment I built myself and this is the first tube tester and set analyzer I know anything of. It was built just after the "X" base came out, when most of the tubes were 200 and 201A and before "C" batteries had come into general use. At least, commercial sets weren't equipped with them.

The UV200 and UX200 were still being much used because the "A-, B-" both tied together. Don't know as I should bore you with a description as the picture is explanatory, but you could hook the radio set to the row of binding posts and play it through the analyzer, and by changing the "B+" power to the Ma. post could read the drain of the set, which was a great help sometimes. A power cable made up of a 5-wire battery cable, and an old UX base served to connect the analyzer to the batteries. Such as it was it really worked.

I hope it is of interest.  
 ALF. E. DILLE.  
 Grinnell, Iowa.

## BAFFLES, ETC.

Dear Editor:  
 In the September, 1940, issue of *Radio-Craft*, I saw a small article headed "Where to Find Data on Speaker Baffles." To me, the field of speaker baffles and exponential horns is one of the most interesting in all of radio. Let's have more articles on practical cabinet-type baffles using bass reflex, folded exponential horns, and the like. I wonder if A. C. Shaney would be so kind as to put the mathematics of the Jensen "bass reflex" principles used in their commercial baffles, into one of his articles? I'm sure there are a lot of Servicemen and experimenters, who like to dabble in P.A. work, who would like to design their own horns and amplifiers. Let's have some dope on horns for them, Hmmm?

The articles on amplifiers in your mag. always draw my last quarter out of my pocket the minute I see the issue on the newsstand.

All in all, you have a very good magazine.  
 Love,  
 A READER,  
 Stoughton, Wis.

Mr. Shaney has agreed to prepare an article on speaker baffles to appear in a forthcoming issue of *Radio-Craft*. Oh!, and thank you for your "bouquet"!

## TED POWELL'S ARTICLE

Dear Editor:  
 Please don't think that I am criticizing the article by Ted Powell in the October issue of *Radio-Craft*, as I am really seeking information.

The point I speak of is his explanation of the "unorthodox paradox" of radio re-

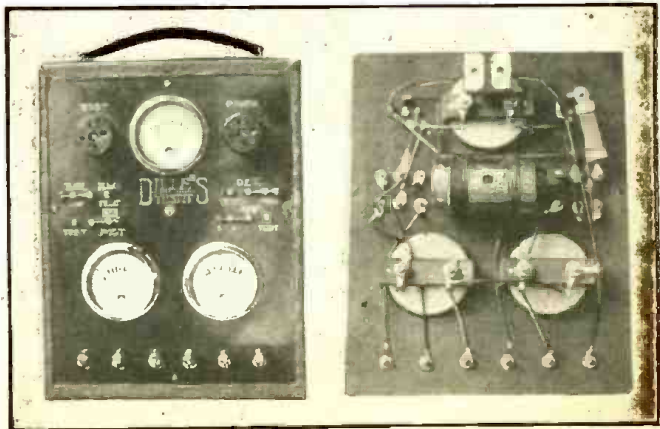

Mr. Alf. E. Dille, of Grinnell, Iowa, built this tube and set tester away back when the "X" base first came out and when most of the radio tubes were of the 200 and 201A types. This was even before the "C" batteries came into general use. Notice the old-fashion sockets, knife switches, and magnetic-vane type meters used on the front panel.

ception when a ground wire is hooked to the aerial post of a radio set.

It seems to me that this would be normal to the set, even with a theoretically "perfect" ground. As one side of the antenna coil is connected to chassis, and the power line is usually bypassed to the chassis, the R.F. energy picked up by the power line is impressed across the antenna coil and gives a much stronger signal than could be explained by a high-impedance ground. One proof of this is that a battery radio set works very poorly without an aerial.

J. N. GILBERT,  
Athens, Tenn.

This letter was forwarded to the author whose reply follows:

Dear Mr. Gilbert:

The writer will confess to having made a misleading statement, and to a certain extent, stands corrected. Instead of saying—"The answer to this question is much simpler than they might suspect," he should have said, "Most of the answer to this question is much simpler than they might suspect".

The writer's answer to this criticism will be made in a multi-part fashion.

In the first place, the writer is a bit confused by Mr. Gilbert's proof of the point he's attempting to bring out when he says that a battery set will work very poorly without an aerial when the question under discussion involves the exchange of the ground and aerial.

In the second place, the writer would like to point out to the reader that, as he already mentioned in the article itself, when we start to go into details of this field, we start to get into complexities that get even the experts to walking in circles. It was only recently that one or two of the causes of external cross-modulation were finally tracked down. The writer will frankly admit that one could go through this article and pick out nearly a dozen statements and ask some rather embarrassing questions that would stump or else make things difficult for even an authority. When Mr. Gilbert states that "—the R.F. energy picked up by the power line is impressed across the antenna coil . . . etc." he is making a much too simple and a far too incomplete analysis of the actual, complicated reactions taking place. The writer apologizes for implying that the explanation given was complete and as simple as all that. It must be remembered that this is only a magazine article and many details cannot be gone into because of space limitations. As it was, the editor was forced to cut out some superfluous paragraphs from this article.

Now for a partial explanation. When Mr. Gilbert makes his statement (the power line R.F. energy is "impressed" across the antenna coil) he makes the same sort of an unstrategic move that is commonly made by many "hams" and other amateurs when confronted by a radio circuit which they do not understand and which they are attempting to analyze. They will begin by saying "Now when A is positive, B must be negative, therefore grid 2 is charged negatively, etc., etc." Here is a circuit with its resistances, reactances; electrostatic, magnetic, and electromagnetic fields; steady, pulsating and transient D.C.; sinusoid, complex and transient A.C. at power, audio and R.F.; all the radiation, rectification conduction, capacity and induction effects; the phase relationships between these effects; and finally, the combination of all these effects in a circuit in a transient or steady-dynamic state. All these possibilities staring him in the face and our imaginary amateur attempts to explain away all this as if it were some childish battery-resistance network in the steady state.

When we are confronted by an A.C. circuit of more than an elementary nature (especially where R.F. currents are involved) we cannot say "if this is so, and this is so, then a signal will be induced in such and such a spot, or, if this is negative and this is positive, then that will be negative and rectification will take place, etc."

When the circuit is not too involved we can set up polar vectors which will give us a solution and a sort of a "picture" of what is going on in the circuit at any given instant. When the circuit begins to get complicated, we break down our circuits on paper, into "equivalent" networks of parameters, and then handle them with higher math. and get fairly accurate results. When dealing with involved conditions then we must break up our networks into roughly equivalent parameters and handle them with complex mathematics, some of which was especially developed for electrical engineering purposes (operational calculus, hyperbolic functions, complex quantities, etc.). Of course, the point under discussion is not as involved as might be implied here, and the above statements were made in order to bring out the point that when we deal with A.C. theory we cannot explain away things with simple words or vague generalities.

Mr. Gilbert was quite correct in bringing out the point that more than the impedance effects of a ground are involved (the "grounding" of power line signals through the antenna primary). The writer not only concedes this point but will go even further. As the article stated, we must also allow for the radiation, re-radiation, conduction, induction, and capacity coupling effects between antenna, ground wire, receiver chassis, building wire, masses of metal in the receiver locality, and the ground beneath the locality; the existence of certain rectification effects in the receiver locality (power-line tunable hum and exterior cross-modulation); the phase relationships between these effects; and finally, the combinations of these effects possible.

The previously italicized "phase-relationships" was italicized for the simple reason that the phase relationship between the power line input, the receiver antenna input, and the ground wire "signal", might be such that addition of a "ground" wire or power line R.F. input might decrease rather than increase the total signal input to the receiver because of near 180 deg. cancellation. Even accepting Mr. Gilbert's assumption of a "perfect" (non-impedance) ground, the addition of a power-line R.F. signal could cause an A.C. set to have a lower total input than an equivalent battery set, because of this possible phase relationship. Mr. Gilbert's assumption of an "impedanceless" ground seems rather futile to the writer. We can turn around and say—"The power-line also has no impedance, therefore no R.F. signals (potentials) exist in it and there is no point to discuss." We could even assume further extremes and say—"The receiver circuits also have no impedances, and therefore, no reception is possible because there are no impedance drops, no potentials, no currents and therefore no signals."

However, the writer stands partially corrected for making a rather loose statement (and he is no doubt guilty of many more for reasons already explained). If Mr. Gilbert has any more questions on his mind, the writer will be glad to attempt their answers to his limited capacity.

TED POWELL,  
Maspseth, Long Island, N. Y.

This discussion reminds your Managing Editor of the article, "Where Does the Ground Begin?" which appeared, many years ago in "QST" magazine, in the "rotten radio" series by "The Old Man"! Remember?



# RADIO made EASY

LEARN AT HOME - IN SPARE TIME!

36 Volumes in 1 Big Book!

1. Broadcasting System
2. S. O. n. d. Speech. M. c. i. e. r. s.
3. Electron Theory: Electric Current.
4. Elec. Units: Ohm's Law.
5. Elec. Circuits: Batteries.
6. Magnetism.
7. Electromagnetism.
8. Electromagnetic Induction.
9. Inductance.
10. Capacitance; Condensers.
11. A. C. Circuits.
12. Transformers.
13. Measuring Instruments.
14. Radio Waves.
15. Broadcasting.
16. Receiving.
17. Vacuum Tube Principles.
18. V. T. Characteristics.
19. Vacuum Tube Construction.
20. V. T. Detector and Amplifier Action.
21. Radio Frequency Amplification.
22. "Superhets."
23. R. F. Amplifiers; Tuning Coils.
24. Audio Amplifiers.
25. Loudspeakers
26. Battery Receivers.
27. Power-Supply Units.
28. Elec. Receiv. etc.
29. Auto and Aircraft Radios.
30. Phone Pick-ups; Sound Systems.
31. Short-Waves.
32. Photoelectric Cells; Cathode-Ray.
33. Television.
34. Antennas and Grounds.
35. Testin. g. Servicing.
36. Sound Pictures.

Ghirard's COMPLETE Course will train you QUICKLY

Here's your BIG CHANCE to get a thorough training in basic RADIO FUNDAMENTALS—quickly, easily, without previous experience or study. Today there are BIG OPPORTUNITIES and lots more jobs for men with radio training—in radio factories, in radio service shops—and in all branches of the Army and Navy.

RADIO, SOUND, TELEVISION —MADE EASY AS A. B. C.

Ghirard's famous RADIO PHYSICS COURSE is the quickest short-cut radio training you can find. The most complete and most economical tool. His clear explanations, 1000 illustrations, and 856 self-testing Review Questions make it as easy to understand as a primer. Thousands of successful radio men got their start with this book, and it's used by more radio schools and students than any other radio text in the world! Get this whole 972-page course today for only \$4—and get started on your own radio career!

Use it 5 Days

—OUR RISK!

Your money back if not fully satisfied. Don't delay—get started—mail this coupon at once!

972 Pages  
508 Illus.

Only \$4

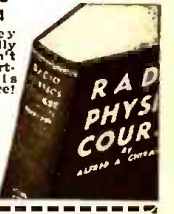

RUSH COUPON TODAY!

Radio & Tech. Publ. Co., Dept. RC-21, 45 Astor Pl., N. Y.

Enclosed find \$4. (\$4.50 foreign) for my copy of "RADIO PHYSICS COURSE" with your 5-day Money-Back Guarantee.

Name \_\_\_\_\_

Address \_\_\_\_\_

City \_\_\_\_\_ State \_\_\_\_\_

Send me free literature.

## REWARD FOR TRAINING

-Better Jobs!  
-Increased Salaries!

- CREI trained men are well rewarded for their earnest ambition to succeed in Radio. Surveys disclose that CREI graduates, as a group, are among the HIGHEST PAID IN RADIO . . . 69% enjoy SALARY INCREASES during or immediately after their training!
- If you are no longer content with your present progress in radio—if you are anxious to advance to the better radio job you KNOW should be yours—now is the time to investigate the opportunities that await you through CREI training in advanced Practical Radio Engineering. 5,000 RADIO-MEN CAN'T BE WRONG! They're the men who have already turned to CREI for the advanced training they realized is necessary for success. Can't we help YOU?

WRITE US TODAY —

If you are a professional radioman and want to make more money—let us prove we have the answer to your problem. Our free booklet gives complete details—without obligation. To help us intelligently answer your inquiry—please state briefly your education, radio experience and present position.

**CAPITOL RADIO**  
Engineering Institute

Dept. RC-2, 3224 16th Street, N.W., Washington, D. C.



Get Your Copy Yet?  
**THE AMPLIFIER HANDBOOK & PUBLIC ADDRESS GUIDE**  
See Page 488

# For Better Servicing - For Bigger Profits -

FOR A WIDER KNOWLEDGE OF TECHNICAL SUBJECTS, READ THE

## BOOKS IN THE RADIO-CRAFT LIBRARY SERIES

GET into the swing of reading instructive, authoritative books on technical subjects—Radio, Air Conditioning and Refrigeration. The RADIO-CRAFT LIBRARY SERIES is the most complete set of volumes individually treating all important divisions in these fields. Each book has been written for the purpose of giving you the opportunity to specialize in one or more of the popular branches of the various subjects and we know of no easier, quicker or less expensive way to improve your knowledge. The material in each book is very helpful—you'll find them valuable in your work. The authors are all well known and are authorities on the subjects on which they have written. This is the first time that you are enabled to build a library of technical books by such popular writers.

### ALL BOOKS ARE UNIFORM

The books in the RADIO-CRAFT LIBRARY SERIES are all uniform. The size is 6 x 9 inches. Each volume contains 64 pages and an average of 50 to 150 photographic illustrations and diagrams. The books are printed on an excellent grade of book paper and have stiff flexible covers. PRICE 50c PER BOOK. All books are sent postpaid.

|  |   |  |  |  |   |  |
|--|---|--|--|--|---|--|
|  <p><b>Book No. 13</b><br/><b>ABC OF AIR CONDITIONING</b><br/>An accurate simplified technical review of the fundamentals of this latest branch of engineering. Including servicing data on present-day units. By Paul O. Harrison.<br/>50c</p>   |  <p><b>Book No. 14</b><br/><b>POCKET RADIO GUIDE</b><br/>Edited by N. M. Lessam. Handy Reference Book for Radio Men — Set Construction Articles — Audio Amplifier Circuits — Useful Radio Formulas and Data — Handy Short-Cuts.<br/>50c</p> |  <p><b>Book No. 17</b><br/><b>SERVING WITH SET ANALYZERS</b><br/>A Study of the Theory and Proper Application of Modern Set Analyzers and Associated Apparatus. By H. G. McEntee.<br/>50c</p> |  <p><b>Book No. 21</b><br/><b>BREAKING INTO RADIO SERVICING</b><br/>Simple Instructions and Procedure for Starting a Profitable Radio Servicing Business of Your Own. By Robert Eichberg.<br/>50c</p> |  |   |  |
|  <p><b>Book No. 15</b><br/><b>ABC OF REFRIGERATION</b><br/>A carefully written volume, starting with the basic principles of refrigeration by mechanical means, and leading up to a complete analysis of the servicing of commercially available units. By Trafton Mason.<br/>50c</p> |  <p><b>Book No. 18</b><br/><b>POINT-TO-POINT RESISTANCE ANALYSIS</b><br/>For Service Men Theory—and Application of this Modern Test Procedure to 'Everyday' Radio Service Problems. By Bertram M. Freed.<br/>50c</p>                       |  <p><b>Book No. 22</b><br/><b>NEW RADIO QUESTIONS AND ANSWERS</b><br/>Answers to Questions Most Frequently Asked by Both Novices and Experts. By Robert Eichberg.<br/>50c</p>             |  <p><b>Book No. 16</b><br/><b>PRACTICAL RADIO CIRCUITS</b><br/>A Comprehensive Guide to All Types of Radio Circuits for the Service Man, Constructor and Experimenter. By David Bellare.<br/>50c</p>  |  <p><b>Book No. 19</b><br/><b>PRACTICAL RADIO KINKS AND SHORT CUTS</b><br/>The contents of this book have been planned with the view to help Radio Dealers, Servicemen, Experimenters and Set Builders.<br/>By B. Baker Bryant.<br/>50c</p> |  <p><b>Book No. 20</b><br/><b>THE CATHODE-RAY OSCILLOSCOPE</b><br/>Theory and Function. Power Supplies and Associated Circuits, Sweep Circuits, Operation of Typical Unit. Methods of Measurement, Practical Applications of C-R Oscillographs. By Charles Scuranza.<br/>50c</p> |  <p><b>Book No. 23</b><br/><b>PRACTICAL PUBLIC ADDRESS</b><br/>Modern Methods of Servicing and Installing Public Address Equipment. By B. Baker Bryant.<br/>50c</p> |
|  <p><b>Book No. 24</b><br/><b>AUTOMOBILE RADIO PRINCIPLES AND PRACTICE</b><br/>A Complete Treatise on the Subject Covering All Phases from Installing to Servicing and Maintenance. By B. Baker Bryant.<br/>50c</p>   |   |  |  |  |   |  |

New titles are constantly being added to the RADIO-CRAFT LIBRARY SERIES. But, on the other hand, stocks of certain titles are running low, and they may not be reprinted for some time. We would therefore suggest that at this time you order as many different titles as you are interested in. Remember, that if you delay, some of the books may later be out of print.

**USE THIS HANDY COUPON WHEN ORDERING**

**RADCRAFT PUBLICATIONS, Inc.**  
20 VESEY STREET NEW YORK, N. Y.

RADIO-CRAFT for FEBRUARY, 1941

RADCRAFT PUBLICATIONS, Inc., 20 VESEY ST., NEW YORK, N. Y.  
Gentlemen: Enclosed find my remittance of \$..... for which send me, POSTPAID, the books indicated below.

RADIO-CRAFT LIBRARY SERIES @ 50c EACH  
Circle book numbers wanted: 13 14 15 16 17 18 19 20 21 22 23 24

Name ..... Address .....

City ..... State .....

(Send remittance in form of check or money order; register your letter if you send cash or unused U. S. Postage Stamps.) RC-241



# RADIO-CRAFT

"RADIO'S GREATEST MAGAZINE"

## RADIO MEN— WAKE UP!

By the Editor — HUGO GERNSBACK

.... the need in a radio world that moves faster than ever before is men who can think

**T**HE most difficult thing for human beings—as Arthur Brisbane was fond of saying—is *thinking*. Nowadays our complex civilization makes such great demands upon us that most of the time we are satisfied to let others do the thinking for us— which may be more pleasant, but usually much less productive, too.

This outburst is caused by the hundreds of letters which pass over my desk from well-meaning radio men who bemoan the fact that radio opportunities have "gone with the wind" never to return, and that everything in radio is as dead as a burned-out vacuum tube.

The trouble here is that these good people do not think, yet all around them *the radio world hums and moves at a speed far greater than ever before!* Then we are told that there is no room for radio improvements unless you have capital, "influence" and what not.

The difficulty today is that radio men and those who know anything at all about radio experimenting refuse to think, and thus miss all the great opportunities of this, the Radio Age.

For years, *Radio-Craft* for instance, pioneered in the small portable set. The Editors of *Radio-Craft* originated any number of these but no one seemed to take the cue until last year the Radio Corporation of America saw the light and engineered the first really small *commercial* portable, weighing only a few pounds and measuring only 9x3½x3 ins. deep. This set caused an immediate sensation and the company for many months was unable to fill orders.

**POCKET RADIO SET:** The Pocket Radio Set which I have mentioned for years in my various articles is as yet not on the market. When I say a pocket radio set I mean a *pocket* set. Such a set, in my opinion, must have dimensions not greater than 7x4½x1½ ins. You must be able to slip it easily into your pocket otherwise it cannot be considered to fill the bill. Such a set need not have a loudspeaker so powerful as to fill an entire room with sound. In other words, the sound need not be of great intensity. If taken from your pocket and placed in front of you one foot away from your head, you should be able to listen to a program without straining your hearing. That would be sufficient. Such a set *can* be made today by any first-class radio experimenter who also must know how to design the right shape as well.

*Millions of such sets could be sold at anywhere from \$7.50 to \$10 at a good profit.* The new small (midget) tubes not larger than a thimble have recently been announced and these tubes give the key to the entire pocket set. Whoever makes the first of such sets—and provided it is well engineered—will find no trouble to attract capital for the manufacture of such receivers.

**DESK RADIO SET:** Every business man needs a radio set on his desk. Now with the new tubes above mentioned, a small battery desk set can be readily engineered by any clever radio experimenter. Such a set must also have utility. That is, it should not be just another radio set. It should have a pen on each side, the set being in the center and a place for pencils, memo pad, etc., and other essentials for the executive or business man. *An entirely new market can be opened up on a set of this type.*

**PERSONAL MIKE:** I mentioned this some years ago and I repeat it here for what it is worth. Stage performers, night-club entertainers, public speakers, and so-on, still are bound to the present type of microphone perched on a stand. The minute they move away from the mike you no longer can hear them. A particularly unimaginative contraption is today's unwieldy microphone-stand, that gets into the way of the speaker or performer, has to be carried backward or forward, hides the performer's face and keeps him chained in front of it.

All of this is, of course, *unnecessary* because with a little ingenuity, any average technician can get up a rig (along the lines of "wireless" microphones originated by *Radio-Craft*) that can be carried on the person of the performer or speaker. The microphone

can be concealed under the dress, in the case of a woman underneath the shirt or inside of the vest pocket of the male performer. Concealed in the clothing is a small amplifier and radio transmitter, employing again the new miniature radio tubes. We now have a perambulating human radio station. No matter where the performer is on the stage or platform the radio impulses will be picked up by a wire, either over head or under foot, and the performer can walk around without being chained to a fixed microphone.

**GARAGE DOOR OPENER:** The problem of getting the car easily into the small privately-owned garage still has not been solved. At the present time it is necessary to get out of your car, open the garage door, get back into your car and then run the car into the garage. If you are rich enough and can afford servants, or if your wife or children are around, they may do the service for you, but everyone knows that this usually is not the case. Particularly on rainy or stormy days the garage door problem becomes a nuisance of the first magnitude.

By means of present-day radio instrumentalities it should not be too difficult for a clever radio man to get up a small transmitter that can be placed in the car and operated by the automobile storage battery. The radio receiving set antenna can be used as a radiator, if necessary, by throwing a switch. In the garage there will be a receiver which by means of simple relays operates a small motor which in turn opens the door. The impulse, of course, would be sent by the owner simply by pressing a key or button 10 feet away from the garage while the radio remote control would do the rest. The important requirement in such a system is that it must be cheap. It should not cost over \$20 to \$30 at the most to install.

**INTEROFFICE FACSIMILE:** While radio stations are now beginning to adopt Radio Facsimile so that you will have radio programs printed when you wake up in the morning, there is a growing need for a cheap and practical Interoffice Facsimile Set. Thousands of offices throughout the country can use, and would welcome, such sets. You cannot always use the telephone in communicating certain information between offices. There are such things as sketches, figures, OKs to be given by managers and officials, and thousands of other requirements, and so today, the officials make memoranda and send them around by messengers. This consumes time, particularly in large plants.

Banks all require such systems to verify signatures, etc. Yes, there is already such a system in use, as for instance the Teleautograph, but such systems are expensive at the present time; also, they do *not* permit checking signatures, etc., at the remote point. They are used only in the larger banks and in some of our very large corporations. What is needed is a cheap interoffice facsimile based upon radio instrumentalities. Moreover, the sender and receiver must be identical and interchangeable and should not take up more room than a book. This will make it convenient to be used on any desk. *Thousands can be sold.*

**POCKET SERVICE KIT:** For the imaginative radio Serviceman, some serious thought should be given to a very small Pocket Radio Servicing Kit. Something small enough to be placed into a pocket. Such a specialized instrument would of course have to be very compact. With present-day methods, and radio means which are in existence today, audio oscillators, radio-frequency oscillators, etc., all can be made exceedingly small. Such a servicing pocket set, of course, would not replace standard instruments, but it would be an adjunct to these and could be used for preliminary work, and also for check-up purposes. Such a pocket set can be made to sell for less than \$10.

The list is really endless. There are hundreds of new ideas that can be evolved similar to the ones given and many of these can give their originators a comfortable living if only they think about it long enough and have sufficient gumption to carry out the ideas.

# • THE RADIO MONTH IN REVIEW •

The "radio news" paper for busy radio men. An illustrated digest of the important happenings of the month in every branch of the radio field.

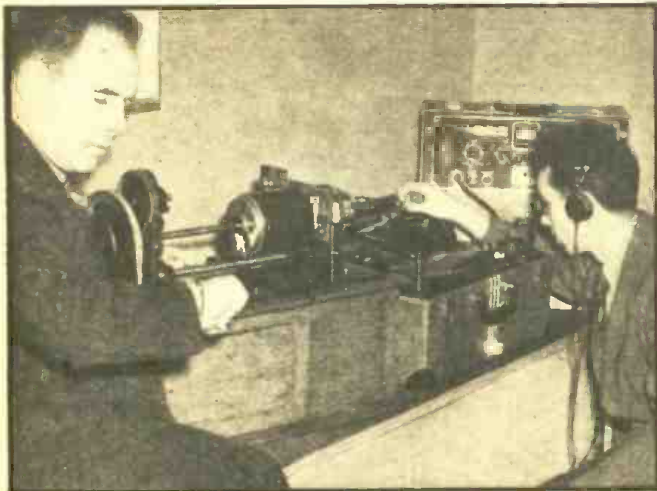

## NATIONAL VOCARIUM

Mr. Vincent's childhood dream becomes a reality! Since 1913, he has been collecting cylinder records of famous voices until his library presently totals 3,000 voices. Kings, queens, all the Presidents since Taft, and other famous voices including Edison, Roosevelt, Pope Leo XIII, are included in the collection. Here Mr. Vincent (left), and assistant, Mr. Savory, are re-recording the Kinetophone record of Andrew Carnegie's speech, "The Gospel of Wealth". To preserve the older voices for posterity, Vincent is re-recording early cylinder records onto modern discs. Special sapphire needles must be ground to exactly fit each old record's sound-groove!

Photo—Rudy Arnold



## SPARKO—ROBOT DOG

Elektro, the world's most versatile "man" (described in *Radio-Craft*), now has a new playmate, Sparko, first electrical robot dog; both are Westinghouse inventions. Sparko, shown at the N. Y. Fair, wags his tail, sits on his haunches, and yips happily. He is controlled, via a track, by Elektro.



## GERMAN "BOMBER CRASH" RADIO SET

This radio transmitting set, taken from a Heinkel Bomber that was forced down in England, is intended for use either with the umbrella-skeleton aerial or the kite type (right). Nazi airmen use this equipment when forced to take to their rubber lifeboats at sea.

## F.M.

**F**REQUENCY MODULATION transmission and reception via telephone wire facilities is quite feasible, insofar as such transmissions may require the wire-line facilities of the Bell System, A. T. & T. reported last month. Says the report: "If better program transmission channels than those now generally utilized are desired by the broadcasting industry, the Bell System expects to be in a position to meet that need."

Last month, the F.C.C. established rules for 3 groups of F.M. broadcasters, known as classes A, B and C. Class A stations supply F.M. service to a limited trade area and a city; class B, to a basic trade area and a principal city; class C, to an area of at least 15,000 sq. miles comprising primarily a large rural territory and very large portions of the basic trade areas not serviced by class B stations.

Interference to F.M. radio reception is somewhat a rarity except where the noise source may be diathermy equipment. Recognizing that such apparatus must be subject to some reasonable amount of control if radio reception is ever to be "noise free," whether the transmission is F.M. or A.M., the F.C.C. last month convened a technical group to consider ways and means of curbing this pernicious form of interference, as for instance by assigning to it certain wavelength bands, and specifying control equipment to maintain operation within these bands. The Chief Engineer of Station WABC, in addressing the conference, pointed out that "transmissions from diathermy machines are capable of being received across the continent . . . and the sea. The frequencies upon which they operate are used by the national defense and safety services, and interruptions of these services may jeopardize life or property, or seriously affect the nation's interests."

## SOUND

**S**TATION WOR now has a new source of day-program material. Several major Mutual night-time shows originating elsewhere than in WOR's studios, and which cannot be fitted into night schedules of WOR, will be recorded, and played-back over WOR on day-time spots.

The current issue of *Telephone Review*, house organ of the N. Y. Telephone Co., tells how the new newspaper *PM* is planning to use sound-recording equipment. Steel-tape recorders will be used to make spot records of important stories sent in by correspondents over long-distance and trans-Atlantic phone lines.

We wonder if it's true as recently reported in the papers that Uncle Sam now uses super-power P.A. systems to provide simulated salutes? According to the story, ordinary gun-shots are amplified to cannon proportions. Saves wear and tear on the pocket-book. Here's an idea for a safe-'n'-sane Fourth O' July!

## TELEVISION

**D**UAL Frequency Modulation and Amplitude Modulation transmission of television-sound signals, one type of program transmission alternating with the other, was inaugurated over the N.B.C./RCA television system last month! RCA has taken up practical F.M. even if only experimentally.

The new \$100,000 2-story home of W6XAO, main station of the Don Lee Television System, is the first all-television building to be erected in America. This station atop Mount Lee, a 1,700-ft. mountain near Hollywood, Calif., will be completely shielded with 22,600 ft. of pure electro 1-oz. copper sheeting. (Radio-Craft received a sample of this shielding!) This 60-mile-range television station will have, in addition to a 20 x 50 ft. pool, a 60 x 100 ft. and a 25 x 40 ft. stage, each with monitor rooms; an experimental lab.; makeup room; lounge viewing room; performers' lounge and other theatrical facilities, and all other items necessary to make this a completely self-sufficient television building.

The how and why of television, from first principles to actual air programs, is the story told in RCA/N.B.C.'s sound-film, "Television." Pay shipping costs, and your school or club can have the film for a showing. Costs you nothing more.

A step forward in the development of color television in America came with the announcement, last month, that direct pickup for full-color television, using the C.B.S. medium-fidelity system previously described in *Radio-Craft*, had been accomplished using no greater studio illumination than was or-

## PORTABLE MILITARY RADIO

A young student of the Eton College Officers' Training Corps is shown practicing with a portable radio transmitter in maneuvers held on Field Day at Chobham Ridges in Surrey, England. Radio operators following up the advance of their company, can keep in touch with headquarters by means of these 1-man radio sets.

Photo—British Press Combine.



dinarily employed in black-and-white television. The C.B.S. electromechanical system affords higher fidelity than was possible in the mechanical color-television system demonstrated by Bell Telephone Labs. a number of years ago.

*Mechanical color-television systems are too complicated, Allen B. duMont last month commented, and took the occasion to call attention to an electronic color-television system on which he is working, which employs a special screen to automatically segregate at the transmitter and recombine at the receiver all the elements of the color-images. The entire operation is electronic, and hence, requires no moving parts.*

The Nation's capital will have television service as soon as N.B.C. can get its new 1-kw. station in operation in Washington's Wardman Park Hotel. Plan is to later link this station, in automatic relays, with Philadelphia and New York. The main television studio is to be in the 500-seat Wardman Park Theatre.

Lacking time to reach Columbia University in time to open a meeting of the Radio Club of America, Club vice-President John L. Callahan solved the problem by scouting over to Allen B. duMont's station W2XWV, at 515 Madison Ave., N. Y. C., and by special arrangements hastily made for the purpose, there televising to the club members assembled in Columbia's Pupin Hall. Sound was sent by land-line to loudspeakers in the hall because the sound channel of W2XWV is in the process of completion.

## PREPAREDNESS

**A** REFERENCE Committee on Micro-Wave Radio Developments has been set up by the National Research Council. Purpose of the Committee is to act as a clearing house for potential papers by editors or authors on ultra-high frequency research which these persons may feel merit the attention of the Council in cooperating with the Preparedness Program. The Council will pass upon the advisability of temporarily withholding publication of these ideas, and at the same time, assure the inventors of any necessary protection of their brain-children. Chairman of the Committee is Dr. Alfred L. Loomis, Tuxedo Park, N. Y.

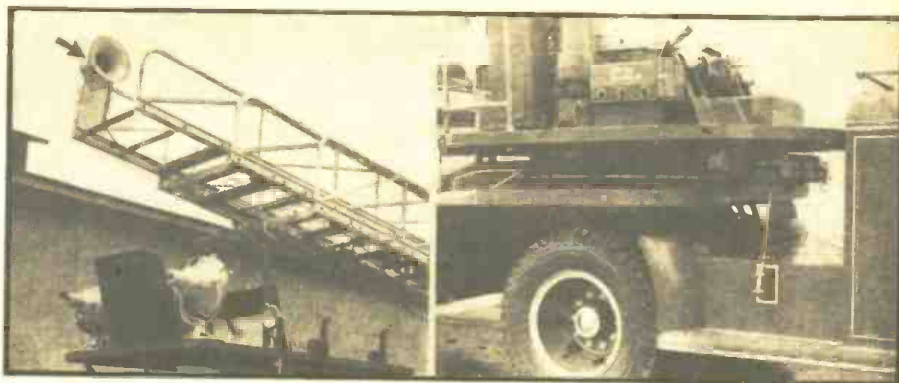

**PUBLIC ADDRESS SYSTEM HELPS FIRE FIGHTERS**

The American-LaFrance Foamite Corporation of Elmira, N. Y., which supplies the fire-fighting trucks for most of our large cities, is now installing public address equipment on their aerial ladder trucks. As illustrated above, the amplifier is mounted on the turntable at the base of the ladder, and the loudspeaker on the very tip of the extension ladder. Thus firemen, at the very tip of the ladder, can be given instantaneous instructions by the fire chief a hundred or more feet below. This is an important addition to fire fighting equipment since it eliminates the hazard of misunderstood orders due to the din of clanking machinery and falling debris—a la May '37 "R-C"! In addition to P.A., some fire-fighting departments have installed 2-way radio systems, but only to the chief's car, or his car and that of his assistant.

## BROADCASTING

**F**IRST air-cooled 50-kw. short-wave broadcast transmitter to go on the air in the United States was Westinghouse station WBOS, in Boston, which last month beamed "neighborly" programs to South American countries; European countries too, were included in the coverage, on 11.87 mc. Advantage of air-cooled tubes, reports Westinghouse engineers, is that operating efficiency is thereby boosted to about 50% in contrast with about 30% for water-cooled operation. The hot air derived by air-cooling then may be piped through a building for heating it in winter.

*A completely around-the-clock broadcast schedule was inaugurated last month for station WMCA. "Hot" music promptly goes "sweet" at a 2 A.M. curfew.*

Did you know that the "Gang Busters" program, on the air over the N.B.C.-Blue net, has bagged 92% of the persons wanted by the police? Radio Turns Detective!

*"Air Waves," an RCA/N.B.C. sound-film telling the story of broadcasting across the years, is available gratis to clubs and school groups which may wish to borrow the reels.*



**TELESCOPIC MICROPHONE**

Ruth Mack, ice skating star, listens-in on the Society of Motion Picture Engineers (meeting in the next room) with this 8 ft. telescopic microphone, developed by Dr. Olson of RCA. This huge mike, which consists of many ear-like tubes each attuned to certain sound frequencies, was designed for use on movie lots, radio studios, theatres, and for spot news pick-ups. It is virtually the machine-gun speaker (Radio-Craft, March, 1940) operating in reverse.

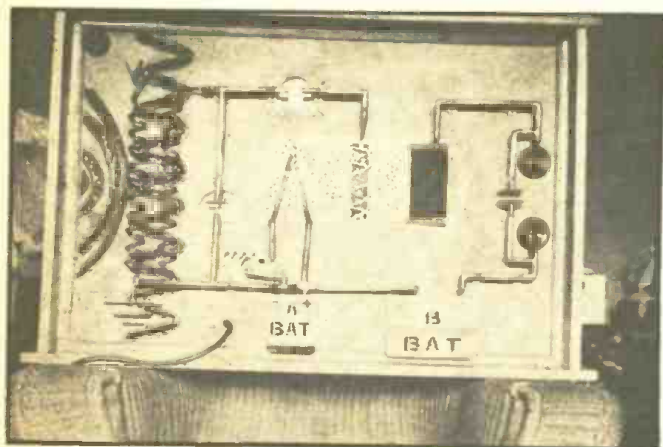

**THE "EXPLORADIO"**

This ingenious instrument is a new device for teaching the principles of the vacuum tube and 1-tube radio receiver in science classes. It is a "model" of a vacuum-tube circuit made of copper and mounted on small insulators. The model is animated by means of colored lights, buzzers and "electrons", thereby conveying very clearly just what takes place when a signal enters the circuit of a 1-tube receiver. The instrument has been tried out successfully in the Roosevelt Junior High School of Cleveland Heights, Ohio. The Exploradio, a patent of Albert L. Dougherty, will run continually or can be stopped at any point in its cycle for necessary explanations.

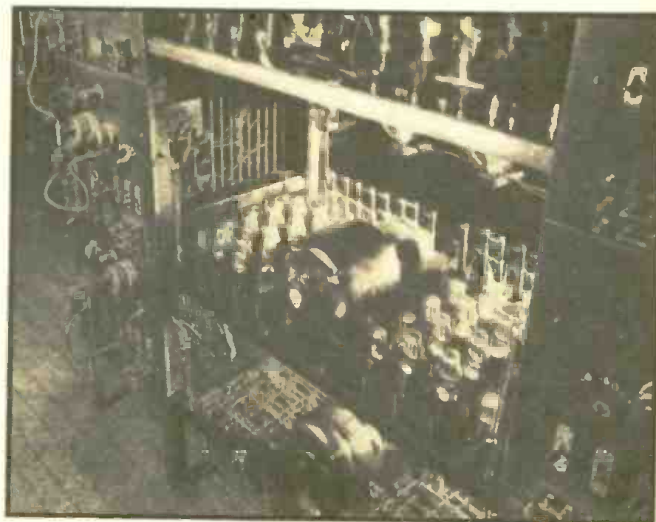

**VIBRATION TEST FOR TUBES**

Tung-Sol Radio tubes are subjected to hours of severe vibration under service conditions at rates ranging from a few vibrations per second to 30 times per second. This is an exaggeration of the vibration which tubes would ordinarily experience if mounted close to a loudspeaker or in an automobile set. No wonder modern tubes last anywhere from 1 to 5 years!

# OPPORTUNITIES IN MILITARY RADIO



Whether Uncle Sam points his finger and says, "I want YOU," or whether you anticipate his desires by enlisting, you radio men, and beginners, will find Mr. Schauers' article on radio in the U.S. Army and Navy equally informative concerning opportunities and rates of pay.

**CHAS. J. SCHAUERS**  
Staff Sgt., U. S. Army Air Corps

◀ Here you see 2 (rear cockpits) of Uncle Sam's 650 Flying Cadets, high over Randolph Field, Texas. At this "West Point of the Air," the "Eaglets" fly their instructors through maneuvers learned on the ground; and put their radio training into practice.

Conscription and enlistment have made, and will continue to make, inroads on embryo and available radio technicians. It was with this in mind that Radio-Craft commissioned Staff-Sergeant Schauers to write the following article, in the conviction:

- (1) That every man in the radio field is entitled to know to what extent his knowledge may be applied in the defense of his country;
- (2) That he is entitled to reasonable assurance that his years of training may be adapted in some manner to the government services and need not be thrown overboard, perhaps for a period of years, because of being assigned to some government service for which he has neither the training nor inclination; and,
- (3) That non-technicians should be informed of possible places for them in Government Radio at this time.

**W**ITH the drawing of the first number out of the historic "ticket bowl" in Washington in October, every man between the ages of 21 and 36 began to wonder what his specific job or duties would be when called to the Colors for the 1-year training period. Many too, wondered when they would be called, and still others pondered over the question of education and advancement during their training period. Among the many men who had to register, there were those who were actively engaged in the Radio Industry.

Radio Servicemen, amateurs (nearly 60,000 of them), radio engineers, technicians, commercial radio operators, and those generally engaged in the field of Radio, have had these thoughts in mind:

"If I am selected for service with the military forces for 1 year, what will I do in my specific line of endeavor?"

"Will I be able to follow my chosen profession?"

"Is it possible for me to receive additional instruction in my type of work?"

"What are my chances of advancement?"

"Has my former training any bearing on my position in the military forces?"

"What should I do, when notified that I am called up to the 'front' for my military training period?"

"What chances have those who had no education in radio, to obtain training in the radio fields?"

"What will my pay be within the 1-year period?"

## COVER FEATURE

Then too, the radioman has been wondering what jobs are available in the military services.

The purpose of this article is to acquaint those radiomen now actively engaged in the radio field who stand a chance of being called for training, and those not in the fields of radio who may be called for training who desire to enter radio as a career, with the information that they should have, in order to realize what they are going into; and how to make use of the advantages offered.

### BRANCHES OF THE SERVICES

It has been said that, if there are enough voluntary enlistments, there will be no large draft for some time to come. However, this doesn't mean that there will be no draft. Under existing conditions, and under unforeseen future developments, it would seem quite logical to assume the attitude that YOU might be called. Therefore, with this attitude in mind, we proceed with this article.

The United States Army embodies many branches, but the only ones we will consider are those that employ radio. Too, we will consider radio in the Navy.

The Signal Corps, Field Artillery, Coast Artillery, Anti-Aircraft, Infantry, Cavalry (Mechanized and Mounted), Air Corps, and Engineers, are branches of the United States Army that employ radio. We will consider them in order.

*Signal Corps.*—Radio operating, and mechanics, are just 2 of the many sub-branches of technical activity of the Signal Corps (pronounced *core!*—Editor).

Schools for training enlisted men and officers in Radio Communications are to be found in the Signal Corps, and the Signal School at Fort Monmouth, New Jersey, is taken to be one of the most modern schools in the United States. Here, the embryo radioman or student can learn the rudiments and advanced concepts of radio operating, radio repairing, teletype operation and maintenance, and telephone work. However, an examination to determine the applicant's adaptability is usually given before entrance to the school is made. (This is the somewhat general rule of all service schools.)

Upon graduation from the Signal School, the graduate student is usually sent back to his original organization, and if he enlisted at the school may be sent anywhere in the United States to any one of the Signal organizations.

*Jobs to be found in the Signal Corps are:* radio operating aboard army transports; radio operating in message center activities; radio operating in field radio stations; and, radio operating in post radio stations.

However, depending upon the branches of service at a specific post, radio operating duties are usually performed by qualified men of a headquarters service staff, or service organization. In addition to radio operating duties in the Signal Corps, there are technical supply jobs which take into consideration the supply of all electronic material used by the other branches of the Army.

The job of technical supply embodies much study, and is a very important one not to be considered too lightly.

Teletype maintenance and operation are jobs that require skill and specific training . . . the Signal Corps supplies a good part of the maintenance men and operators for other branches of the Service.

Radio repairing at schools, etc., is usually taken care of by Signal Corps personnel. However, at main depots where the work comes in large amounts, civilian personnel under Civil Service contracts do the greater part of the repair work.

Telephone work, even though not directly associated with radio, is a technical field and any radioman who has had previous, systematic training is quite capable of learning telephone work to great advantage.

*Field Artillery.*—The Field Artillery (FA) employs radio for many purposes, but outstanding among the sub-branches again,

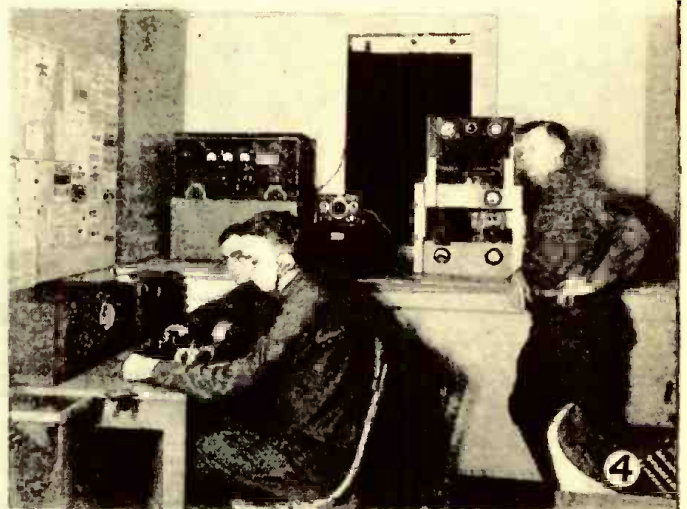
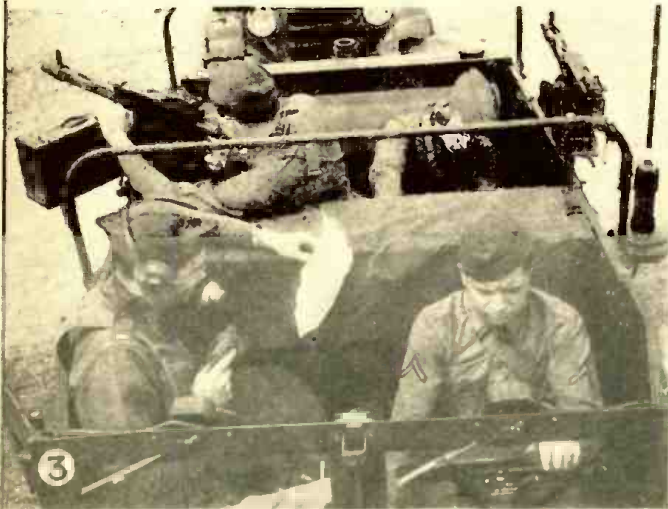

Some of the many uses of Radio in the Services. (1) Command car with radio equipment, 6th Cavalry, 3rd Army Maneuvers, 1940. Photo, U. S. Army Signal Corps, Ft. Lewis, Wash. (2) Army radio students receiving instruction in portable 2-way field set operation. Note hand-driven generator on tripod. (3) Scout car in action, sending messages while protected by machine gunner, at Ft. Myer, Va. Photo, U. S. Army Signal Corps. (4) At Ft. Lewis, Wash., students practice code over an Army Amateur Radio station built of salvaged parts. (Instructor, right.) Photo, U.S. Army Air Corps. (5) Command post, radio hook-up; gun position, 75 mm. gun of 83rd Field Artillery, 3rd Army Ma-

neuvres, 1940. Photo, U. S. Army Air Corps, Ft. Lewis, Wash. (6) Pictured here is a code class of the 3rd Signal Company. Classes like these are conducted every day by trained Army instructors. Cover Photo: Trained radio control operators are needed to handle traffic problems when 300 airplanes are in the air at one time at Randolph Field, Texas, Uncle Sam's giant "West Point of the Air" training field, where the picture shown on the cover of this issue of *Radio-Craft* was taken. The signal, "OK, clear," of the Radio Dispatcher, foreground, starts aloft one of this year's 7,000 pilots-to-be, or Flying Cadets, for the day's acrobatic practice.

# • RADIO DEFENSE •

is radio operating. Radio operators are needed for field radio stations, division radio stations, command post radio stations, and small sublet stations.

Telephony plays a very important part in the FA and is used to communicate with nearly every element. However, radio is coming into greater use as the art of high-frequency communication progresses.

The radio-electrician's job in the FA is a very important one and takes into being the installation and maintenance of all types of radio equipment.

**Coast Artillery.**—The Coast Artillery also employs radio for communication between elements, and radio operators who have received good, sound training are prime requisites. Radio repair technicians are needed too for the very important work of maintaining radio equipment of batteries and higher headquarters.

**Anti-Aircraft.**—Even though somewhat a sub-branch of the Air Corps, Anti-Aircraft and other Units also utilize radio, and wherever radio is to be found here, radio operators and repairers are needed.

**Infantry.**—Another branch is the Infantry, which also utilizes radio, and all types of radiomen are needed in this very important branch of the Army.

**Cavalry (Mechanized and Mounted).**—Now that the Cavalry is becoming more and more mechanized day by day, radio communication between armored cars, headquarters sections, etc., is coming into greater prominence, with the result that trained radio operators, and maintenance men are needed.

**Air Corps.**—The United States Army Air Corps employs radio communication for many purposes. For communication with aircraft from ground stations; between aircraft in the air; between squadrons; between posts; and between higher headquarters sections.

Aircraft radio operators (these must be trained men) are used in large and medium bombing planes, observation planes, and transports. Control tower radio operators need special training in traffic problems, and this is the job where the operator must constantly be "on his toes!"

The Air Corps Technical School located at Chanute Field, with branches at Denver (Colorado), and Bellville (Illinois), trains men in the Air Corps and even other branches of the services in radio operating, radio repairing, teletype maintenance and operation, instrument training, etc. This school employs the most modern equipment and trained instructors for teaching the "aviation soldier" what he should know about the job to which he has been assigned.

The radio maintenance man of the Air Corps must receive specialized training which will enable him to maintain the complicated equipment used throughout the nation in each of the squadrons of the Military Air Forces.

**Navy.**—In the Navy, radio communication is a "main standby." The Navy radiomen are classified as some of the best technical heads in the radio industry. This is due largely to the systematic training received at the Navy's schools.

Radio operators are employed aboard ship, in the air, and on the ground; and radio mechanics are utilized to great advantage by the naval forces. Too, radiomen are employed in submarines, and therefore, the Navy covers them all: land, sea, and air!

**Coast Guard.**—The Coast Guard is somewhat comparable to the Navy and employs radiomen for about the same purposes.

## INDIVIDUAL QUALIFICATIONS

Answering the first question in the forefront of this article: "If I am selected for

service with the military forces for 1 year, what will I do in my specific line of endeavor?"

It would stand to reason that your job in the military forces would be one of help and not of hindrance. If you're a radioman, there are many chances to one that you would be employed as a radioman in your particular line of endeavor, whether it be radio servicing, radio operating, or engineering. There more than likely will be a place for you! The selective board at one of the reception centers, after considering your qualifications will probably assign you to a squadron, company, or battery, wherein your services will be appreciated and used. However, additional training will have to be undergone before your full value is felt.

Civilian radio and military radio hold no contrasts, because the principles involved are the same. But the application of those principles in different ways tends to throw a vari-colored light upon the situation.

If you are a Serviceman, used to servicing home sets, you'll run into something different at every turn of the road in the Service! You will still be able to apply your previous technical training, and there will be much that you will learn about your work, but you'll apply your training in many different ways.

If you're an accomplished radio operator, either commercial or amateur, you'll receive the surprise of your life in new operating

## NEXT MONTH— V.-T. Voltmeters

Most radio men are familiar with the vacuum-tube voltmeter—the principles of A.C. and D.C. measuring types, the slideback design, etc.—but Mr. Moody in a technical review of recent literature on this subject, in March "Radio-Craft," draws useful comparisons and shows detail circuits of types of interest not only to Servicemen but also to technicians in other branches of radio.

methods. However, if you are a licensed amateur, and have been actively engaged in one or more of the Army or Navy Nets, radio operating will come very easy to you, as used in the Services.

There are some of you who might say, "Well, I'm a radio engineer, and have a Degree, what place is there for me, besides radio operating and maintenance?"

Your place, my "prospective soldier," will no doubt be one of technical concern. You'll either become an instructor (after you have received some additional instruction yourself), or become a chief in charge of a radio section in either a battery, squadron, or company.

Your previous training will do much toward deciding where you will be working, and what you will be working at!

## ADDITIONAL TRAINING

The question of additional instruction is one of major consideration.

For those not engaged in the radio industry, there will be an education program which will teach beginners how to repair, operate, and maintain radio equipment of all kinds.

This is the main reason that military radiomen who have been trained are so valuable. They have received the benefits derived from working with various types of equipment, and have received specialized training which is not to be found in civilian schools.

It will be quite possible for the man who has had no previous training prior to his entrance into the Army, to acquire training in radio which will be more than just a casu-

al start toward a permanent career in radio.

Your chances of advancement are entirely dependent upon yourself. Initiative takes the lead in the Army and Navy, and the prime requisite of advancement is study, individual study

*Depending upon previous training, etc., the average radioman should advance within the 1-year period far ahead of those who have had no training; because radio is, and always will be, a "back-bone" of communication.*

When you are notified that you have been chosen for 1-year service, it will be up to you to let the reception center board know about your qualifications.

It won't be necessary for you to continually talk about your qualifications, but it would be a very plausible idea for you to acquaint those who have something to do with your placement, with your qualifications for a specific job.

Those who ask the questions, are the ones you want to tell your qualifications to! You'll know when!

Examinations are usually given to each applicant to determine what he is able to do best . . . when your examination comes up, always state your preference for the type of work that you might want to do. However, if you should stop and think for a minute, that when you leave the forces at the end of your year of training, there are others who will take your place, you will readily see that specific training is absolutely necessary. Not only for you, but for the other fellow as well. A continuous training program will be in session, the reason is obvious.

## RATES OF PAY

In the Navy and Army the first base pay is taken to be \$21.00 per month . . . at the end of 4 months it usually jumps to \$30.00 per month, respectively. Then if you qualify for specialists' ratings your pay will increase proportionately . . . this will depend on the availability of ratings and your qualifications.

The pay of an enlisted man in the U. S. Army who has over 4 years' service, and not more than 8, is as follows:

|                    |       |          |
|--------------------|-------|----------|
| Master Sergeant    | ..... | \$138.00 |
| Technical Sergeant | ..... | 92.40    |
| Staff Sergeant     | ..... | 79.20    |
| Sergeant           | ..... | 66.00    |
| Corporal           | ..... | 59.40    |
| 1st Class Private  | ..... | 39.60    |
| Private            | ..... | *30.00   |
| Private            | ..... | **21.00  |

\*After 4 months. \*\*First 4 months.

Privates may receive specialists' ratings. They are as follows: (These specialist ratings are in addition to regular base pay.)

|                      |       |         |
|----------------------|-------|---------|
| 1st class specialist | ..... | \$30.00 |
| 2nd class specialist | ..... | 21.00   |
| 3rd class specialist | ..... | 20.00   |
| 4th class specialist | ..... | 15.00   |
| 5th class specialist | ..... | 6.00    |
| 6th class specialist | ..... | 3.00    |

For the base pay of personnel with less than 4 years' service, deduct 10%.

The Air Corps (U. S. Army) has Air Mechanics ratings (2nd and 1st Class), which pay \$72 and \$84, respectively.

The pay rate in the Navy is somewhat higher than the Army for corresponding ratings.

If you are ready to serve the United States for one year, wholeheartedly, and desire to benefit by that 1-year's service, you'll step to the front . . . especially in the field of Radio!

The opinions and statements contained in this article are those of the author and are not necessarily to be construed to indicate the attitudes or policies of either the War Department or the Air Corps.

# RADIO BLACKOUT ON THE HIGH SEAS

*Lives depend upon the vigilance of the Radio Officer, when "the silence of war descends on the sea." One such Radio Officer, now playing a quietly heroic role in the British Mercantile fleet, tells the thrilling story of how the radio man afloat in the service of a belligerent during war times acts, with the Captain, to help save lives and property; both the Admiralty and the Home Office depend upon him not to make a single misstep in the use of his radio equipment.*

## BERNARD CLIVE McCORRY

*(Prisoner of War on the Graf Spee and Altmark after the Huntsman, on which he was Radio Officer, was sunk by the raider.)*



BERNARD CLIVE McCORRY

Now a Radio Officer "somewhere on the High Seas," in His Majesty's Mercantile Service.

**W**HEN a war breaks out the thousands of ships of the British Mercantile fleet are scattered far and wide along the trade routes of the world.

If you were some colossus high above the earth's surface and could listen-in with ear phones to the peace-time radio conversations of ships at sea, you would hear a telegraph hubbub of sound resembling market day at some giant eastern bazaar. This is the voice of the ocean. It talks all the languages of the universe, as from land-to-ship, ship-to-land and ship-to-ship flash a myriad miscellaneous messages that range from Admiralty instructions to birthday greetings to Aunt Agatha.

In peace time the "wireless" (radio) office of any merchant ship transmits and receives news, ocean letters, weather reports and the hundred and one private communications made to and from passengers. It keeps in touch with the owners of the ship, reports progress and receives instructions. Night and day the atmosphere is criss-crossed with electrical impulses as dots and dashes spell out the daily fortune of humanity.

In such times, as I know well enough from having traveled for 28 different shipping companies to all parts of the world, the Radio Officer is kept moderately busy both transmitting and receiving messages. But apart from his "Conversation" side of the job he has other responsible duties. Without wearying you with technicalities let me cite two of them: the operation of the direction finder; and, the taking of soundings. These are tasks of the utmost importance in navigating the ship.

In your mind's eye, then, you have a mental picture of sea radio operations before the outbreak of a war, the oceans of the world perpetually buzzing with Morse.

**T**hen comes a war. The immediate effect of this is that a sudden silence descends on the seas. The thousands of messages, which a little while before were being broadcast around the globe, suddenly stop. It is like the scene in a large class room of small boys left to their own devices. In no time bedlam reigns. Then in walks the Headmaster. At once everyone stops talking. Instead, they all listen.

It is not strictly correct to say that war halts all radio conversations. There is nothing to stop non-belligerents carrying on with transmitting and receiving as in normal times, though these days, with neutral ships a target for unscrupulous attacks, they naturally do not advertise their positions more than they can help.

As far as British merchantmen were concerned, the war silenced their radio equipment, except in emergencies. The effect on the Radio Officer is that his work from the transmitting point of view is immediately cut down. There are 2 Radio Officers on the majority of ships in war time and they do at least 8 hours' duty a day. The telegraphic side of his job becomes one of continual listening. Hours and hours of dreary waiting. Then suddenly the dramatic sounds that mean life or death to those on board.

In war time the merchant ship's radio apparatus becomes the connecting link between the Admiralty and the Captain of

each ship. The Admiralty gives its orders to ships all over the world. The owners cannot communicate with the vessel except through this channel. And of course the land stations relay Admiralty messages. For instance, if we were off South Africa we should pick up the orders from one of the transmitting stations in the Union.

**W**hat does the Radio Officer listen for? He listens for the slightest sign of any danger, for news, in voice or code, of raiders, submarines and aircraft. The news comes from a variety of sources, from ships in the vicinity of enemy aircraft, from land or from the enemy themselves. On how he acts under the circumstances may depend the safety of the ship. Indeed one cannot over-estimate the value of a good Radio Officer to the Captain of a ship. If I were a skipper I should be quite sure I had a good man in the wireless cabin, especially in war time.

For instance, there was a case a few months ago, of a ship going on fire. A radio message was then sent out calling for assistance and asking for someone to stand by. A German battleship picked up the message and hurried to the spot. On the way he captured a British ship.

While I was in the *Huntsman* I picked-up a fire call like this. In peace time we should have made all haste to the rescue. Not so

Perhaps not as sleek as the radio equipment on the luxurious liners, but nevertheless very effective, is this modern Marconi radio installation aboard an English passenger boat. The complete receiver and (right) transmitter are shown.

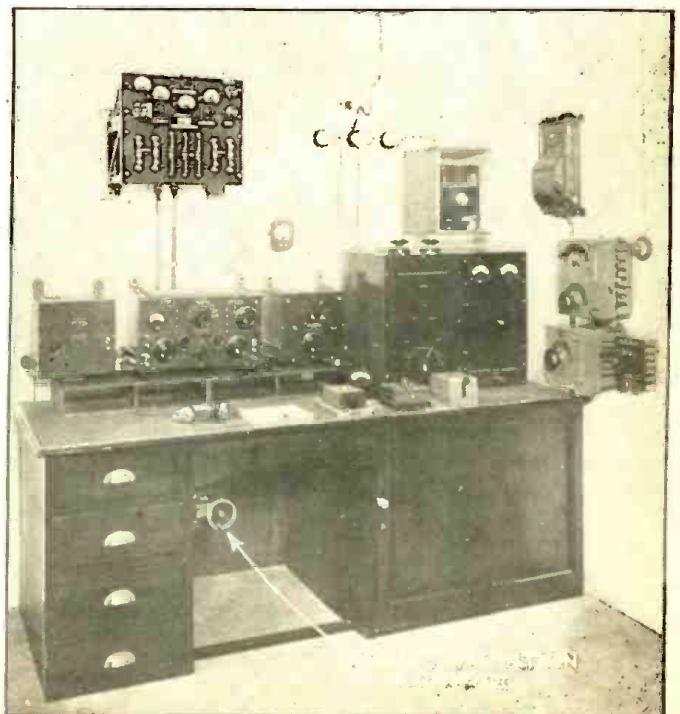

# Presenting the 1941

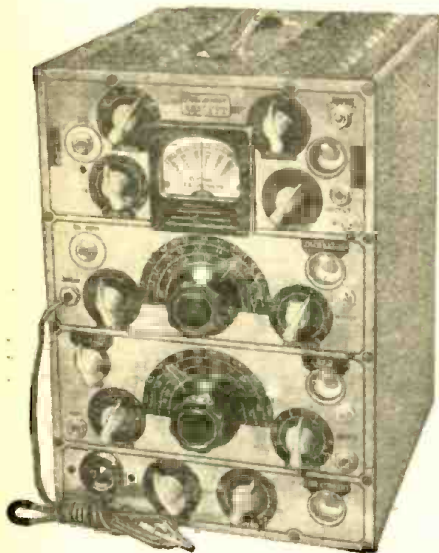

## Meissner ANALYST

Incorporating a New, Direct-Reading  
ELECTRONIC VOLTMETER

Save Time—Save Money—Handle service jobs faster with the assurance that they will "stay sold"! Almost Magical in its uncanny ability to ferret out obscure faults and lay them open for your inspection, the New Meissner ANALYST handles the receivers of yesterday, today and tomorrow—with equal efficiency and facility. Entirely fundamental in its testing procedure, it is one piece of equipment that will never become obsolete!

The New Meissner ANALYST locates faults by the "Signal Tracing" method—proven to be the fastest and most reliable. Five separate and distinct "channels" provide as many different functions, each in its own panel division with all controls accurately calibrated. Furnished with tubes and instructions, complete—ready to go to work!

No. 9-1040 New ANALYST **\$87.50**  
Complete with Tubes, Net . . .

Limited Quantity of 1940 Models  
Available at Reduced Price!

The same ANALYST that sold in kit form at \$100 list—now offered completely wired, with full set of 13 tubes—ready to operate! Similar to the New ANALYST described above except has electron-ray indicator instead of meter for DC measurements.

No. 9-1025 Net Price . . . **\$69.50**

Write for Free 1941 General Catalog

Dept. C-2



when war is on. We hurried off as fast as we could away from the signals. As our skipper said that might possibly be the *Graf Spee*. In any case neutral ships and the Navy would investigate the matter.

Remember that hostilities not only silence the ship's "radio" but they cut off the radio beacons in many parts of the world that guide the sea traffic through fog and mist. It is here that a smart radio officer can be invaluable in assisting the Navigating Staff. Moreover, when nearing land, the "echometer"—the device which, by plotting vibrations on a chart, records the depth of the sea bed—is a priceless aid to navigation.

There you have in theory then the duties of a Radio Officer. And let me conclude by giving an instance from my own experiences.

I spent 6 weeks as a prisoner in the *Altmark* and then was transferred together with some brother officers to the *Graf Spee*. Here we spent 3 weeks which included the glorious action of the River Platte. I had during this period a very practical demonstration of other duties a Radio Officer must perform in order to fall in line with his shipmates.

It was 5:30 in the afternoon and I was having tea, with the *Huntsman* 3 or 4 days from Freetown on the West African coast, when an officer came down from the bridge to say he had sighted a warship and didn't like the look of her.

We all went to our stations and I started up our ¼-kw. transmitter. This is not a powerful transmitter and unless a naval ship was fairly close they would never hear our message. However I began sending "Warship approaching. Warship approaching." Some Captains would hesitate to use their wireless at this stage, because it might immediately, as it has done several times during the war, have drawn the fire of the enemy. I kept sending the message. I did not expect anyone to answer because by so doing they would have disclosed their position.

The warship had a French flag up, but when it had drawn nearer they put up the Hitler flag so I changed my message to "German warship approaching" and gave our position. In a very short time the warship signaled us to stop using our radio and I received my orders from the Captain to stop transmitting. That was the last message I sent out for a long time.

In no time a German with a revolver was telling me in English to "stand over there." Had we any arms on the ship he asked. I said if we had they would not be much use against those 11" guns over there. He kept pointing his revolver at me and his hand was shaking as he had been running and climbing ladders. I was afraid it might go off, so to relieve the tension I asked him if he knew Hamburg? He smiled and said he was born at Kiel and thereupon he put

his revolver away and I felt easier.

The boarding party from the *Graf Spee* stayed with us for a week and during this time the Captain told us to be decent to them as they were only doing their duty, he said. So we played darts: Hitler's team versus Chamberlain's. Except that they had the biggest appetites I have ever seen the German sailors were normal enough. A good many of them however appeared to be country lads and not born to the sea. At the end of this week we were transferred to the *Altmark* which the *Graf Spee* had been away to fetch. And the poor old *Huntsman* was blown up.

In the *Spee* we were put in a room 17 ft. by 20 ft. and 7 ft. high and there I met for the first time that charming man Captain Dove of the *Africa Shell*. He was alone in the room and we were soon swapping experiences. We told him of life in the *Altmark* and he replied of his spell alone in the *Spee*. I took to him at once, he was so cheery and understanding, and I think the liking was reciprocated. We helped each other in many ways and during the battle, the two of us tried to amuse our shipmates, by giving a running commentary on the German activities outside our door (as we were both talk and able to see, through two small holes in the door).

It was during this action, that I formed my opinion, that Britain could not be beaten. After 6 weeks down a hold, with only 4 hour of exercise in the day, my companions and I were again completely locked up away from the light of day. During all this trying time my shipmates were wonderful. Some nations think that Great Britain is growing old, but the German crew in the *Spee* I am sure did not think so, when they had seen us playing like boys again, in that small room. Tugs of war, dances, cards, gymnastic displays and a variety of diversions kept our morale up, so that when the battle took place we were in good heart.

I have seen the identical spirit, displayed in London recently, where I spent 2 weeks of my last leave. This great city is younger and more hopeful than it ever was and danger has brought all ranks together again, just as it did to us in the *Altmark* and *Graf Spee*. I could tell you many wonderful stories of the heroism of just the man in the street but it would take too much space.

I will conclude by saying that on my last voyage I was called the super-optimist on our chances in the War and now after my recent visit to London, my optimism has still further increased. The last time I was in America I came over in Sir Thomas Lip-ton's yacht *Erin* escorting the *Shamrock V* and I am very eager to see how your great country is reacting to the War. I, for one, am very grateful for the help you are giving us and I hope we shall always remain great friends. For there are many ways we can assist each other, both at war and in peace.

## NEWS SHORTS

Child refugees in America broadcast greetings to relatives back home via an N.B.C. program. Radio keeps in good working order its ability to serve humanity.

Broadcasts from the United States soon will reach Latin American listeners in the 20 republics south of the Rio Grande, as re-broadcast over local station, under arrangements announced last month by the National Broadcasting Company. Recordings too will be sent to these stations for airing. Main purpose of the arrangement is to speed development of Pan-American solidarity. In-

identally, this will tend to short-circuit the pirating of programs which has been slowly growing to considerable proportions. As readers of this department will recall, the trick is for stations to make spot recordings of North American stations' best programs, and re-broadcast them without any credit to the source.

In "British Columbia's New Schoolmaster", *The Rotarian* current issue, author Bette Hughes tells how "Mr. Radio" is helping in the education of children in this Dominion.





## YOUR RADIO TRAINING AND THE DEFENSE PROGRAM

*Young men look to the future wondering how our important task of creating a defense will affect their lives. Mr. Smith, in this message which he has prepared especially for you, makes it clear that you have a solemn duty to perform for our Nation and that this duty also presents greater opportunities to trained Radio men.*

J. E. SMITH,  
President, National  
Radio Institute

THE idea of mobilizing for defense in order to preserve peace is now gripping the attention of our nation. Each person will feel the many reactions from this momentous task. Each person is giving genuine support, thereby knitting our nation more closely together.

But preparations for National Defense are tending to affect our outlook toward the immediate future. Many of us fear that long-cherished plans may have to be laid aside temporarily. In many industries, conditions have changed radically within the last few months, so that new opportunities present themselves.

Radio plays an important part in our National Defense program. Since Radio is also your chosen field, I am taking this opportunity to analyze the manner in which our National Defense program may affect you as a radio man.

First of all, we have the indisputable fact that the general public in the United States is more interested now than ever before in news broadcasts telling of the fast-moving events in Europe and the Far East. The reactions of our own Government as reported by radio commentators are likewise eagerly received by the radio audience.

Another important observation we can make at the present time is that people are listening to radio entertainment today more than ever before. Perhaps this is being done to counteract the many discouraging news broadcasts. Important speeches each attract additional listeners who might otherwise leave their receivers turned off.

Thus, radio broadcasting has become a vital influence in our daily lives. More than 45,000,000 radio receivers are now in American homes, with thousands more being purchased each day. Furthermore, each radio receiver owner is insisting that his set be in good working condition so that he will not miss a single important broadcast.

Today it is no longer unusual to find a person owning 2, 3 or even more radio receivers. People like to be near a receiver regardless of where they may be—on a camping trip, at the office, in an up-stairs bedroom, or touring in an automobile. Increased receiver sales due to this desire for extra sets means more work for every one connected with the radio manufacturing industry. Furthermore, the increasing number of sets in use and the desire to have every set in working order is making radio servicing a more vital and more important profession than ever before. We can therefore conclude that the events which have led us into a National Defense program will multiply the opportunities in radio servicing and in practically every other branch of Radio.

Modern Army, Navy and Air forces require reliable and fast communication be-

tween each active unit. Radio is the best medium for this communication, as experience in Europe this year has shown. In many cases, radio is the only means of communicating between moving units.

To provide, maintain and operate a complete modern communication system for an armed force requires thousands of radio operators and radio service technicians. To meet this demand, many radio Servicemen and amateurs have already enlisted in the communication branches of our armed forces. But these will not be enough; many more young men with radio training will be required.

Many of the men who are now being drafted for one year of military training will be assigned to the Army signal corps and to the other communication branches. Those who have had their radio training will no doubt be given preference when these positions are assigned. Furthermore, we have been told that those who are now taking a course in radio training will be encouraged to finish that course, and may be given additional training and practical experience after they have completed their course.

The absorption of trained radio men by our National Defense program is reducing the number of radio Servicemen available for ordinary servicing work. Added to this is the increased demand for radio technicians created by the rapid increase in the number of receivers in active use. Never before in the rapid rise of radio broadcasting has there been a greater demand for trained radio technicians. Clearly, National Defense is creating greater opportunities in at least one field, that of Radio.

I honestly believe that the future of a radio man is more promising now than ever before. The relatively new fields of Frequency-Modulation broadcasting, Television and Electronic Control will develop along with the defense preparation. Trained men should have new avenues in which to find real opportunities for themselves in these busy and rapidly expanding branches of Radio.

There is no reason why a young man who is soon to reach his 21st birthday should be bewildered at all by possible conscription now or in the near future. Likewise, men who are now within the draft age limit should not give up their desire to be trained radio men, for in both cases this radio training will be of great benefit to our Government, to the general public and to the individual himself.

Men who cannot qualify for participation in the National Defense program because they are outside the age limit or for other reasons, should not overlook the fact that this country urgently needs trained radio men to take the place of those who are now serving their country or who will soon be called for service. By furnishing competent radio service to the public, these men will be helping our nation to maintain its reputation for being the best informed of all nations, and will thereby be helping to bolster the bonds of Freedom and Justice.



Here's the Big Book of  
**RADIO VALUES**

**FREE**

**GET IT NOW!  
212 PAGES!**

**EVERYTHING IN RADIO!**



**85 NEW  
Knight  
RADIOS**

See them all—1941's Radio Hits! Models for every purpose—at every price. Plastic and wood mantle models; world-wide sets; "Personals" and 3-way Portables; Recorders and Phono-Radio Combinations; Auto Sets; Farm Radios; Amateur Receivers—all at new low prices! See them in this greatest of Radio Catalogs!



Save money on  
**EVERYTHING IN RADIO**

**24 NEW SOUND SYSTEMS.** complete P.A. listings; all new Amateur receivers and complete Ham gear selections; parts, tools, test equipment, books—more than 15,000 quality radio items—you'll find Everything in Radio at Lowest Prices in your ALLIED Catalog!



**RADIO BUILDERS!**

**BUILD YOUR OWN!** Count on ALLIED for the latest low-cost kits and for help in building any type of radio circuit. ALLIED is Headquarters for Radio Builders!

The "Radio Builders' Handbook"—valuable technicians' book on radio; easy to understand. Illustrated. Only **10c**

New! "Radio Dictionary"—Compiled by experts, under ALLIED supervision. Gives concise, easy-to-understand definitions of all commonly used radio terms and words. Only **10c**



**DON'T MISS THE BARGAIN SECTION!**

**ALLIED RADIO**

833 W. Jackson Blvd. Dept. 2-B-1  
Chicago, Illinois

- Send me your FREE 1941 Radio Catalog.
- I enclose 10c for New Radio Dictionary.
- I enclose 10c for Radio Builders' Handbook.

Name .....

Address .....

City ..... State .....

**FREE CATALOG**

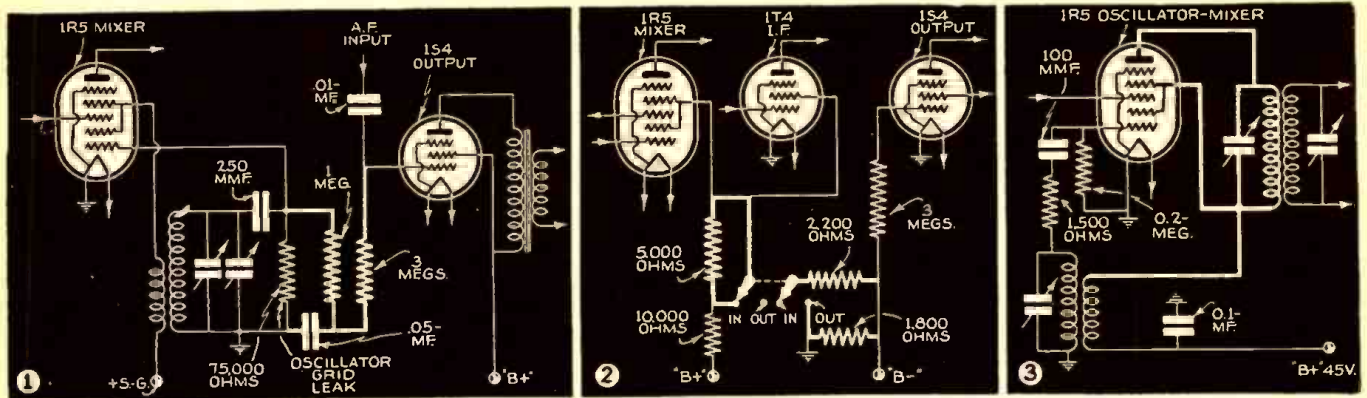

# NEW CIRCUITS IN MODERN RADIO RECEIVERS



In this series, a well-known technician analyzes each new improvement in radio receiver circuits. A veritable compendium of modern radio engineering developments.

F. L. SPRAYBERRY

No. 41

(Fig. 1) OSCILLATOR DEVELOPS OUTPUT BIAS VOLTAGE

General Electric model JB-410.—The normal negative voltage developed on the oscillator grid by grid rectification is filtered and applied as a bias on the output amplifier tube.

From Fig. 1, you will note that a 1-meg-ohm resistor is in series with a 3-meg. resistor connecting the oscillator grid of the osc.-mod. and the 1S4 output grid. The junction of the resistors is bypassed with a 0.05-mf. condenser serving as both an R.F. and A.F. filter.

This method of producing the output tube bias eliminates the lost plate-to-cathode voltage and power loss in the bias resistor ordinarily used in the negative plate supply lead. In a small receiver of this kind with very limited battery capacity, this circuit represents a relatively great advantage.

(Fig. 2) DOUBLE CIRCUIT ECONOMIZER USED IN PORTABLE CIRCUIT

Emerson models DU-379, 380.—In addition to the circuit for increase of the output bias which was formerly introduced, the screen voltage of the high frequency tubes is increased to improve sensitivity and gain.

As the circuit in Fig. 2 shows, the output bias switch is ganged with a screen-grid

voltage switch. Thrown in the "OUT" position, the bias switch places the 2,200-ohm resistor in parallel with the 1,800-ohm resistor, thus lowering the bias resistance to normal with 990 ohms resistance (approx.) in the circuit. With this action the screen-grid voltage switch section opens its circuit across the 5,000-ohm resistor, thus lowering the screen-grid voltage. Since the total screen-grid current of the 1R5 and 1T4 is very small in comparison with the 1S4 plate current, there is essentially no economy lost in raising the screen-grid voltage in the "economizer" position. The action, however, offsets the lowered output gain resulting from the over-bias operation of the 1S4.

(Fig. 3) IMPROVED MIXER-OSCILLATOR CIRCUIT DESIGN

Automatic, model "Tom Thumb."—The complete mixer plate circuit is used with the screen-grid as an oscillator anode to insure oscillation and to slightly increase the transconductance of the mixer.

The first I.F. trimmer in Fig. 3 has a sufficiently low reactance at the oscillator frequency so that the plate is essentially connected to the screen-grid. Since there is hardly any more voltage drop across the 1st I.F. primary at the oscillator frequency

than in the usual circuit, the only way that the oscillator frequency could penetrate the I.F. amplifier is through capacitive coupling which is negligible. The circuit is advantageous where low plate and screen-grid voltages are used.

(Fig. 4) SERIES FILAMENTS SWITCHED IN PARALLEL FOR BATTERY OPERATIONS

Stewart-Warner models 15-5X1 to 15-5X9.—The usual series connection of tube filaments permits them to operate from the main rectifier plate current but for battery operation a parallel connection is made by switching without changing the filament connections to each other.

The switching method is shown in Fig. 4. Note that for parallel operation the center and each end of the filament groups is grounded while the intermediate points are connected to "A+." This connection, of course, reverses the polarity of the 2nd and 4th filaments but the receiver circuit is designed so as not to be critical to filament polarity of these tubes.

Although in series operation the 3 filaments other than that of the power tube, furnish the voltage drop for the power tube bias, a "B-" to-ground resistance serves this function during battery operation.

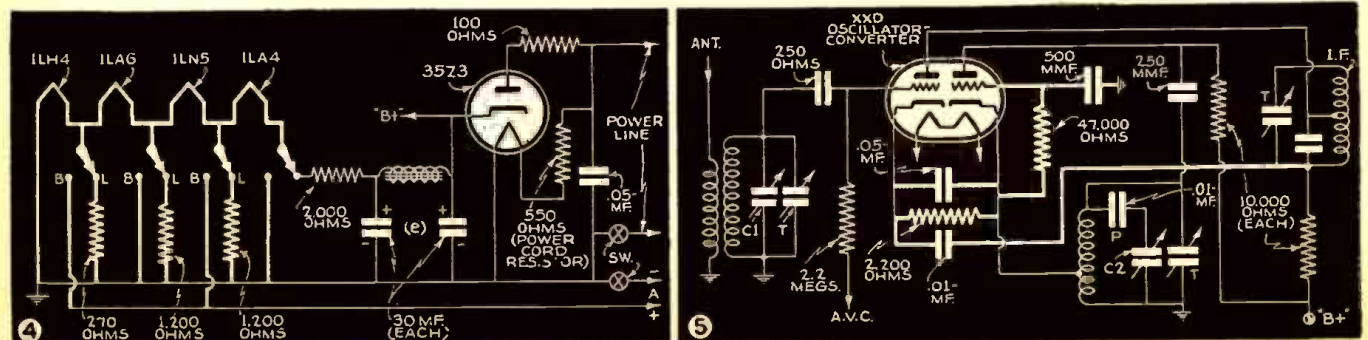

(Fig. 5) DOUBLE TRIODE MAKES PRACTICAL OSCILLATOR-MIXER

Philco models 41-604, -5 -7.—A constant-potential grid type triode oscillator in combination with a triode 1st-detector makes a very practical oscillator - converter circuit in these receivers.

With the small amount of controlled regeneration introduced by the plate-to-cathode feedback, the conversion transconductance of this circuit is as good as that of any multi-element tube. The oscillator cathode is capacity-coupled to the mixer cathode, and a 2,200-ohm resistor is used to bias the latter. The oscillator coil signal current is increased due to its carrying both the mixer and oscillator cathode currents. This intensifies the feedback field and stabilizes the oscillator. The reduced A.C. plate resistance of a triode as a mixer is compensated by a better ratio of plate load to A.C. plate resistance, making the transconductance comparable to any ordinary pentode used in the same circuit.

TONE GUARD

THE RCA Tone Guard is an acoustic network around the opening of the phonograph compartment in some models. It acts as a low-pass filter to reduce passage of the high-frequency sound that is generated and radiated directly into the air by the vibrating parts of the phono pickup.

A cross-section view of the Tone Guard and the equivalent electrical circuit are shown below. The series elements of the filter are formed by the normal slit between cabinet and lid. The shunt elements are formed by slots in the wood strip. The filtering action is very effective, as indicated in curve B below.

This radical new treatment of the acoustical problem presented by record surface and mechanical noises present in all phonographs was revealed to the Acoustical Society of America by Dr. Harry F. Olson at the Chicago meeting of the Society last month.

The new principle is also applicable to soundproof any door or window much more

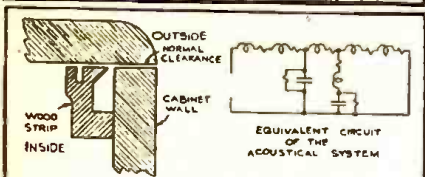
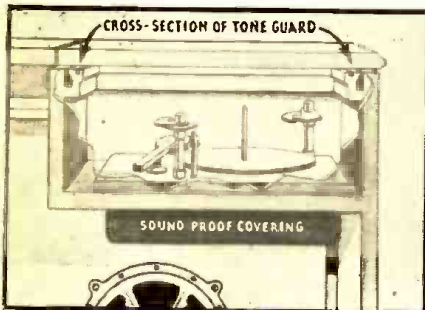

Tone Guard and Equivalent Circuit

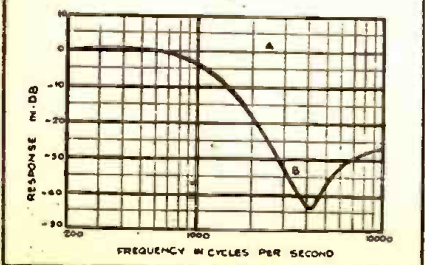

FOR COMPLETE DYNAMIC Signal Analysis

Use Model 560-A Vedolyzer With Model 561 Combination Signal Generator

THE MODEL 561 is radio's most complete signal generator — a combination of four essential instruments which every well equipped serviceman should have. It provides (1) A.F. oscillator, 15 to 15,000 cycles. (2) R.F. oscillator. Variable amplitude or frequency modulated. (3) Carrier and modulation monitor. Vacuum tube circuit. A.F. and R.F. oscillators may be used separately or the variable audio oscillator used to modulate the R.F. Percentage of modulation read directly on meter. (4) Frequency modulator. Double image, positive self-synchronizing. THE MODEL 560-A is a basically different dynamic test instrument using a high frequency 3" scope; 3 stage, wide range, high gain, television, video, vertical amplifiers; multi-range, multi-function, push button controlled, vacuum tube AC, DC ohm and megohm meter; super-sensitive R.F. meter; broadcast, I.F. and oscillator variable tuning section; push button controlled multi-probe input circuit. The Model 560-A Vedolyzer used with the 561 Signal Generator is radio's finest and most complete signal tracing set-up.

Or Use Model 562 Audolyzer With Model 561 Combination Signal Generator

THE MODEL 562 is the simplest and most logical signal tracing and dynamic tester available. Servicemen everywhere are recommending its use because it will start "paying off" an hour after it reaches your shop. It is not necessary to "take out" a few days and learn to operate your new instrument. ONE HOUR with the AUDOLYZER, a test oscillator, and a receiver, and you can tear into those repair jobs you have pushed aside to REST for a while. The AUDOLYZER contains a five inch dynamic speaker for its primary indicating device; a meter to monitor R.F., I.F., A.F., A.V.C., A.F.C., and DC voltages; a two stage tuned amplifier to check frequencies from 95 KC to 14.5 MC; a vernier and step attenuator to control signal level reaching speakers; a vacuum-tube voltmeter to check DC volts from 0 to 1000 volts in seven ranges; an ohmmeter to check resistance from .1 ohm to 20 megohms in 5 ranges; a single probe to be used in any type circuit; dual probes for intermittents.

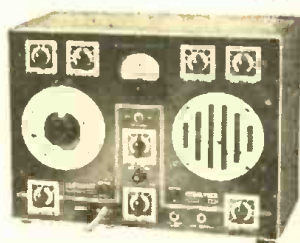

CHOOSE EITHER COMBINATION — YOU CAN'T GO WRONG!

SUPREME

MODEL 571 SIGNAL GENERATOR

THE MODEL 571 is the most economical R.F. Signal Generator for those who have a limited amount to invest and yet desire the features and quality incorporated in the higher priced units. It is capable of providing six types of signals with high stability and accuracy. Other features found only in the expensive generators are double shielding, ladder type attenuator, repeating scales, two modulation levels, illuminated dial, speedy and simple operation which makes an ideal economical set-up for dynamic signal tracing and analysis when used with the Model 562 Audolyzer.

SUPREME INSTRUMENTS CORP. GREENWOOD, MISS., U. S. A.

effectively than has ever been possible before.

Two grooved wells, one considerably larger than the other (see photo) capture sound in the audio frequency range where objectionable mechanical noises exist. When the lid is closed these objectionable sounds enter the space between the cabinet lid and the grooves. A large percentage of them fall into the first groove, where their energy is spent. The balance push forward into the larger groove and are likewise destroyed. Each of the grooves is scientifically designed to destroy objectionable sound frequencies.

The "Tone Guard" together with automatic tone compensation, makes it possible for the first time to reproduce records faithfully at low volume free from objectionable noises or distortion of the original tone.

A phonograph needle of course follows the undulations in the groove of a record and

transforms these undulations into the corresponding electrical variations. In so doing however a 2-fold source of mechanical vibration is developed: (1) the vibration of the various elements of the phono pickup; and, (2) the vibration of the record due to the interaction between the needle and the record, both lead to the production of very high intensity sounds by direct transformation from mechanical variations into acoustical vibrations of surrounding air.

Fortunately the relatively small size of the vibrating elements confines this energy to the high-frequency range. The peculiar conditions under which this sound is generated leads to some distortion in the sound which emanates directly from the pickup and record. Further, the sound caused by mechanical vibration is not in-phase with the sound which emanates from the loudspeaker, and thus becomes objectionable.

**SENTINEL MODEL 227-P "LIGHTWEIGHT CHAMPION" CAMERA-TYPE BATTERY-PORTABLE RADIO SET**

4-Tube Superheterodyne, completely battery-powered; Built-in Loop Antenna; Automatic Volume Control; PM Dynamic Speaker; 1.4-V. Tubes; Range, 535 to 1,600 kc.

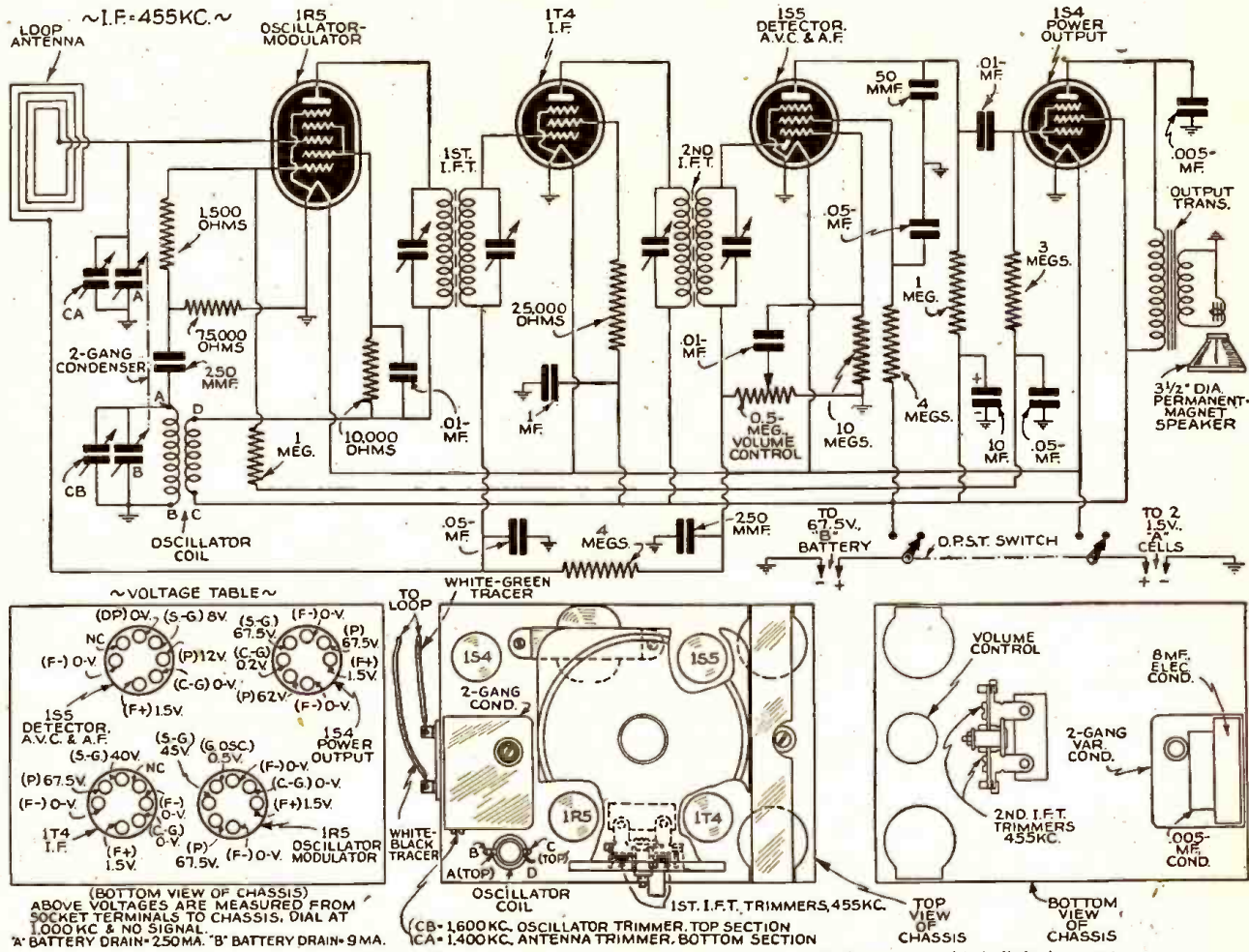

**ALIGNMENT PROCEDURE**

For alignment procedure read tabulations from left to right. If more than one adjustment is required, make the adjustment marked (1) first, (2) next. **IMPORTANT: BEFORE ALIGNING, PLACE LOOP ANTENNA AND BATTERIES IN THE SAME POSITION THEY WILL BE IN WHEN THE SET IS IN THE CABINET.**

When adjusting 1,600-kc. oscillator trimmer and 1,400-kc. antenna trimmer, do not connect test oscillator to loop. Couple test oscillator to receiver loop by: (a) make a loop consisting of 5 to 10 turns of No. 20 to 30 size wire wound on a 3-in. form and attach across output of test oscillator; (b) place test oscillator loop near set loop—**BE SURE THAT NEITHER MOVES WHILE ALIGNING.**

| Set receiver dial to:                             | Adjust test oscillator frequency to: | Use dummy antenna in series with output of test oscillator consisting of: | Attach output of test oscillator to:  | Refer to parts layout diagram for location of trimmers mentioned below:  |
|---|--------------------------------------|---|---|--|
| Any point where no interfering signal is received | Exactly 453 kc.                      | 0.2-mf. condenser   | "High" side to lug on stator of rang condenser to which loop lead is connected. | Adjust each of the 2nd I.F. transformer trimmers for maximum output, then adjust each of the 1st I.F. transformer trimmers for maximum output. |
| Exactly 1,600 kc.                                 | 1,600 kc.                            | None  | Use Small Loop to couple test oscillator to receiver loop.                      | Adjust 1,600 kc. oscillator trimmer for maximum output.  |
| Approx. 1,400 kc.                                 | 1,400 kc.                            | None  | Use Small Loop to couple test oscillator to receiver loop.                      | While rocking rang condenser adjust 1,400 kc. loop trimmer for maximum output.   |

**BATTERY EQUIPMENT**

The receiver is designed to use:  
 Two—1½ volt "A" cells, such as Eveready No. 950 or equivalent flashlight-size cylindrical cell.  
 One—6¾ volt "B" battery, such as Eveready No. 467 or equivalent.  
**IMPORTANT: THE BATTERIES USED MUST BE OF THE CORRECT VOLTAGE AND SIZE.**

The life of the batteries depends on the number of hours the set is operated.  
 Based on average usage, the flashlight "A" cells will supply approx. 10 hours' service—the "B" battery approx. 40 hours' service.  
 Because the "A" cells become exhausted much faster than the "B" battery, 6 to 8 "A" cells may be used during the life of a single "B" battery.  
 Be sure to try new "A" cells before replacing the "B" battery.



Sentinel camera-type portable receiver. Overall cabinet dimensions, 4 7/16 x 4 x 8 13/16 ins.; weight, complete with batteries, 4½ lbs. Since the loop antenna is built into the receiver, it is necessary to rotate entire set for maximum signal pick-up.

SEND FOR THESE FREE CATALOGS  
AND SAVE TRANSPORTATION COSTS  
ON ALL YOUR RADIO EQUIPMENT

Check This Map—and See How You Save  
You Pay Shipping Charges Only From  
Your Nearest Sears Mail Order House



**Free!**

Send for these FREE books Today!  
If you want the Public Address  
Equipment book, write for F732RC-2  
... or the Radio Equipment and  
Supplies book, write for F717RC-2.

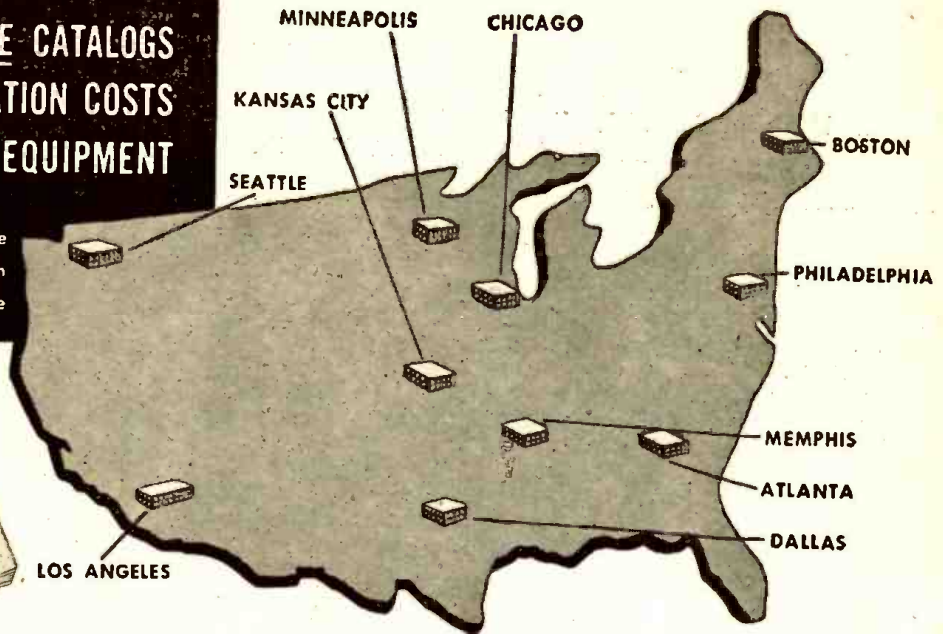

Chances are you're a Service Man or "Ham" who's "sweet" on good Radio Equipment but don't much care for high prices.

If you are, then you're in for a treat when you get your new Public Address or Radio Equipment book from Sears.

You'll see the most complete and up-to-date assortment that anyone could ask for—top-quality Equipment at those low prices

Sears are famous for. What's more, you can buy it all on Sears Easy Payment Plan!

And don't forget—when you buy from Sears, you pay shipping charges *only from your nearest Sears Mail Order House!* You'll save Time—you'll save Money—and you'll be Satisfied! Sears-Roebuck's famous Money-Back Guarantee absolutely protects you.

**SEARS, ROEBUCK AND CO.**

Chicago, Philadelphia, Boston, Kansas City, Minneapolis, Atlanta, Memphis, Dallas, Seattle, Los Angeles

**REFINISHING RADIO CABINETS**

CHARLES R. LEUTZ

**N**EW and additional ways to make money are always interesting to radio Servicemen. One possibility is renewing the finish on metal and wooden cabinets.

**METAL WORK**

First take the case of metal cabinets or panels used extensively for communications receivers and public address equipment. The finish is usually either black or gray wrinkle or crackle. As dust accumulates the finish becomes dull and unattractive. By wiping the surfaces with an oily cloth, the dust is removed and the finish restored. The oil should be thin and clear, a *watch oil* is very satisfactory for this purpose.

When the finish is found to be in bad shape, including grease accumulations, the surfaces should be first cleaned with *carbon tetrachloride* and then given a thin coat of lacquer, gray or black as required. When the rough finish has been worn smooth it becomes necessary to apply a new finish. The old finish can be removed with paint remover or lacquer thinner, dried and rubbed with steel wool.

Gray or black wrinkle paint can then be applied, preferably with an air brush. If the coat is too thin it will not wrinkle properly. If the coat is too thick, the wrinkle is too coarse and will not dry properly. Before applying coats to the desired surfaces, experiments can be made with sample pieces of metal. Wrinkle paint must never be thinned with anything except wrinkle reducer. Wrinkle paint can be obtained either for air drying or baking, and either one properly applied will give very satisfactory results. Used apparatus finished along the

above lines can be made to look like new.

**WOODWORK**

Wooden radio console cabinets can also be refinished to look equal to new. Speaker grille cloths become dull from dust which cannot be entirely removed by brushing. Using a mild soap and damp cloth, the grille cloth can be wiped clean. The operation is followed by washing off the soap with a damp cloth and then wiping dry with a dry cloth.

Cabinet surfaces that are not marred can be cleaned and polished using any good wax or liquid furniture polish.

Wooden cabinets that have worn surfaces can be restored or given an entirely new finish, as required. In the case of a new finish, there is quite a demand for the "blonde" or natural surface. Existing surfaces can be removed with prepared paint removers. A good paint remover can be made by mixing a cup full of *trisodium phosphate* in a quart of hot water. As this is applied, the use of steel wool is suggested to facilitate taking off the old finish. The next operation is to clean the surfaces thoroughly with benzine. Benzine is highly inflammable and care should be taken not to use it near flame. At this point if traces of the original color remain, they can be removed by bleaching, using a hot solution of *oxalic acid*.

**REFINISHING**

The surfaces are now ready for refinishing as desired. For the "blonde" finish, white shellac can be used, thinning same with alcohol. Best results are obtained by several

coats of thin shellac, each one being rubbed down when dry, allowing plenty of time for thorough drying. The coats can be rubbed down with rotten-stone and oil, applied with a piece of felt. The last coat is either left bright or rubbed down dull, as desired.

Another natural finish, one suitable for cabinets used in "play" rooms and which will match a bar finish, is obtained by using a 50-50 mixture of linseed oil (raw) and turpentine. Several applications are required, wiping off the excess in each case and allowing 24 hours between coats.

In place of the natural finish, any desired other finish can be applied as desired, after reducing the surfaces down to the bleached stage. One way to accomplish this is through the use of penetrating *wax finish*. This wax stain is available in several shades, walnut, mahogany, etc. After staining another coat of paste wax is rubbed-in for the final coat. This last coat is allowed to dry for an hour or so and then rubbed briskly with a dry cloth.

**VENEERS**

Most radio cabinets are constructed of veneer glued to a core. Where the veneer has "lifted", it can be glued back in place using *casein glue*, and applying a weight to keep the veneer in place until the glue has set. This glue is marketed under the trade name "Casco".

For the nursery or children's room, cabinets can be finished to match surroundings, for example ivory, by using enamel or lacquer, and brands are available which can be applied by brush and which will give a perfectly smooth finish.

# RADIO SET TO TEST RADIO SETS

The author describes how a radio set, taken on a trade-in, became a valuable piece of shop test equipment. The uses of this "Signal Substituter" are discussed with relation to practical, everyday service problems.

HAROLD DAVIS

**I**N radio servicing, localizing any one particular defect in a set constitutes no unusual problem, but where there are 2 or more dead stages or functions in the same "radio" the complexity of the situations deepens. And when these 2 or more defects present themselves in the form of intermittents, a substantial brick wall against which one may bang his weary head becomes an asset.

To localize multiple defects in a minimum of time, that permits a profit on the job, requires unusual tools and knowledge. One of the most valuable instruments we have used is one that has facilities for picking up, bridging or substituting signals in any part of the defective set, thereby reducing temporary repairs to a minimum and permitting the elimination of that part of the set that is operating normally.

Such an instrument is very easily constructed from any standard 5- or 6-tube superhet. The set should preferably be a good one; and one that incorporates a tuning "eye" tube or facilities for adding one.

The one used here came from a well-known chain store and was acquired via the trade-in route. As a set it performed very nicely before the conversion was begun. And we might say that *this is the first important step*. Have the radio receiver operating perfectly before any changes are attempted.

The parts needed are few and easily obtained, viz., 3 S.P.D.T. switches, a couple of phone plugs and jacks, some shielded wire and a few condensers and resistors. When completed the instrument will provide facilities for:

- (1) Picking-up a signal, in any part of the radio set, which may in turn be monitored on the gadget's loudspeaker and tuning eye.
- (2) Signals, modulated or unmodulated that may be substituted in any part of the defective radio set.
- (3) Bridging arrangements, for jumping defective R.F. and I.F. and audio stages, so that quick estimates may be made without temporary repairs.

Diagram of "Signal Substituter". The switches operate as follows: Sw. I: pos. 1, receives signal tuned by trimmer; pos. 2, receives untuned signal fed in by probe. Sw. II: pos. 1, connects probe to grid of converter (through Sw. I, pos. 2); pos. 2, ditto, of 1st A.F. for Audio In. Sw. III: pos. 1, connects probe 2 to plate of output for Audio Out; pos. 2, ditto, of converter for R.F. Out.

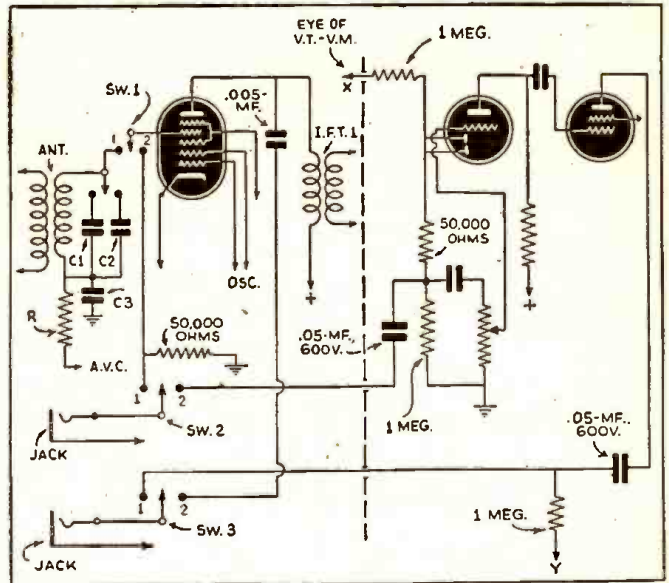

## BASIC PRINCIPLES

To understand the operation of the instrument, it is necessary that the principle of electronic mixing and conversion as applied to the modern superhet. be thoroughly understood. The 1st-Det.-Osc., which is more commonly referred to as the converter, is the heart of the superhet. It is the job of this tube or stage to change the signal applied to its control-grid into a signal that represents the I.F. of the set. This latter signal must contain all the properties of the original signal. If the original signal is being modulated at the broadcasting station by a string band, the converted signal must be likewise modulated.

This is accomplished in the converter by setting up an oscillator circuit in which a new signal is generated to be "mixed" with the original to form the new (or "intermediate") frequency.

If 2 signals are fed into a mixer tube,

there will be 4 signals available at the plate of that tube; the 2 signals fed in, slightly amplified; the sum of the 2; and, the difference of the 2. Besides these fundamental signals, there will be numerous harmonics constituting multiples of these signals.

Accordingly, all that is necessary to change a 600-kc. signal to 460 kc. is to beat or mix it with a 1,060- or 140-kc. source. The first value is universally used in today's supers., i.e., the oscillator is higher than the R.F. signal by the amount of the I.F. The condenser that tunes the oscillator is directly coupled (on the same shaft) to the one that tunes the antenna or R.F. circuit and accordingly tracks along keeping exactly 460 kc. or the amount of the I.F. higher than it.

## THE "GADGET"

However, in the gadget we are building, we desire to take a signal from a broadcasting station and convert it into any desired frequency. This calls for separation of the antenna tuning and oscillator condensers. Inasmuch as one of two stations only, are generally available, we substituted a couple of trimmers tuned to these respective stations for the antenna section of the tuning condenser (as shown in the diagram). This gave us provisions for tuning either of these stations and beating the oscillator against it at any frequency within the range of the latter. On a set that tunes from 550 to 1,800 kc., the oscillator will tune from approximately 1,006 to 2,256 kc., provided the I.F. is 456 kc. Using such a set in our setup it would be possible with a station whose frequency is 1,000 kc. or higher to produce a signal of any desired frequency from zero-beat to 2,256 kc. plus the station frequency.

If the plate of the converter tube is connected to one of the phone jacks through a 0.005-mf. condenser, these signals may be fed directly into the defective radio set.

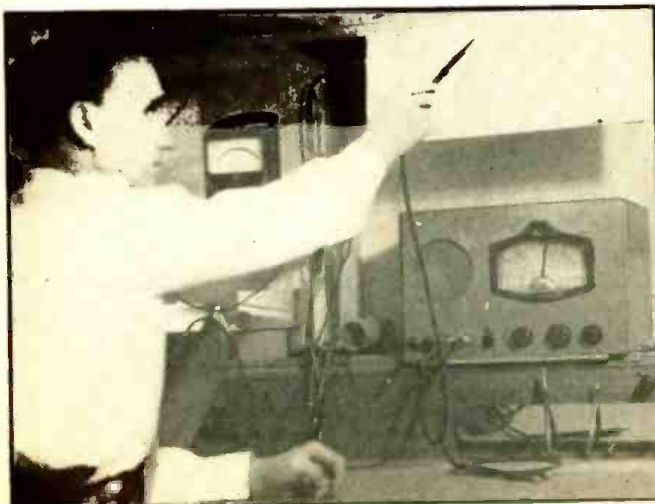

At left is the "Signal Substituter" devised from a commercial radio set obtained as a trade-in. The I.F. is tuned to approx. 550 kc.; shielded test leads, each with a removable 0.1-meg. resistor tip, are used. The tuning eye or V.-T. Vm., for R.F. indications connects to X (see diagram); and, for A.F. indications, to Y.

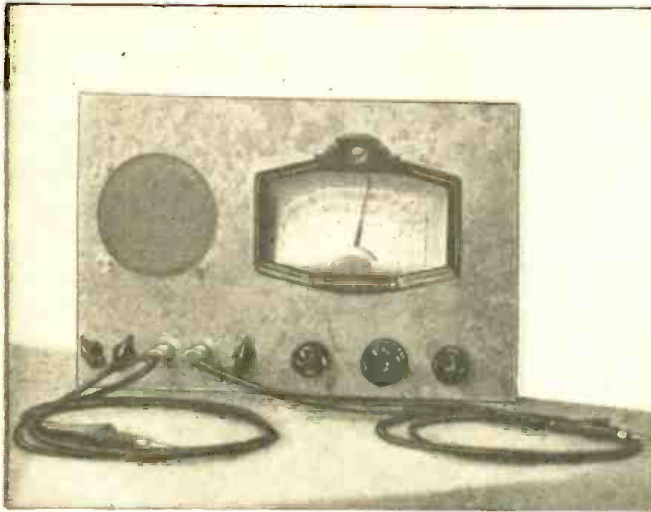

Appearance of the completed "signal substituter". Made by revamping an old radio set, this device demonstrates how a little ingenuity solved problems of economics.

However, detuning now comes into the picture, and to reduce this to a minimum either a 1½ to 2 mmf. condenser (made by twisting 9 or 10 turns of wire together), or a 100,000-ohm resistor, should be used in the lead.

It will be interesting to note that even though the plate of the converter is tuned to the comparatively low frequency of the I.F., plenty of wallop is still available, and no changes we made improved the response enough to warrant them.

Although we now have an instrument which alone is worth its weight in ice cream cones it would be stupid to retire a perfectly good radio from active duty to perform this function alone. By adding a few more switches, and making a few changes, several more very important features can be made available.

**SIGNAL TRACER**

Having a complete set capable of high amplification, there is no reason why it cannot be used to pick up signals from the defective radio set. If one of the S.P.D.T. switches is used to break the control-grid of the converter tube away from the tuned antenna circuit, and connect it to one of the phone jacks as shown in the diagram, signals of any frequency may be fed into the stage. A 50,000-ohm resistor is tied-in at this point to hold down the grid. Since the I.F.s. are still tuned and effective, in order to get this signal through to the loudspeaker and tuning indicator, it is necessary to beat a signal from the oscillator section against it to form an I.F.

To increase the range of the converter, it is recommended that the I.F.s. now be raised to approximately 550 to 600 kc. depending on whether or not any strong stations in that frequency range will cause interference. This also is an advantage in tuning-in I.F. signals which are of approximately 456 kc. If the I.F.s. are set to 600 kc., technically the lowest signal that can be developed into this I.F. is the one of 400 kc. (1,000 kc. minus 400 kc. equals 600 kc.). However, it will be found that sufficient harmonics are present to beat with practically any frequency so that the signal can be heard in the loudspeaker.

At this point we would like to add that raising the I.F.s. 600 kc., or thereabout, does not in any way interfere with the effectiveness of the gadget as a signal substituter. On the contrary, it increases its performance slightly, inasmuch as the higher setting of the I.F.s. builds up the plate impedance so that stronger signals are available on the higher frequencies (around 1,400 kc.).

As in signal substituting, it is recom-

mended that a shielded lead (high-grade crystal mike cable), and a probe with a 100,000-ohm resistor or 1½ mmf. condenser be used for contacting to prevent serious detuning.

**BRIDGING**

Having made provisions for both feeding-in and taking out signals, let's now look into the possibilities of doing both these jobs at the same time.

Suppose a set with a 460 kc. I.F. has that stage out. Placing probe 1 on the plate of the converter tube and probe 2 on the diode, the gadget is used as a *bridger* of the defective stage. Even if the oscillator in the set is not working, the R.F. signal available at the converter plate can be picked up, converted in the gadget to the I.F. and fed back into the set at the 2nd-Det. Any combination may be used.

**SUBSTITUTING OSCILLATOR SIGNALS**

The signals from the oscillator in the gadget may be substituted in a set whose oscillator is dead by simply connecting the probe to the oscillator grid or plate in the defective stage.

**AUDIO IN AND OUT**

Provisions have been made for feeding audio signals in or out of the gadget. In handling audio signals, the 0.1-meg. resistor is used except for high outputs and low inputs where it drops the signal too much. In such cases the probe may be connected directly, however in some instances hum will develop. To reduce this to a minimum, the ground lead from the gadget should be connected to the cathode of the stage that is being worked on. Care must be exercised that the ground lead of the gadget is at electrical ground. Chassis is not always the electrical ground. The frame of the tuning condenser is the best bet.

If the gadget has a tuning eye its sensitivity can be increased by connecting the grid directly to the diode through a 1-meg. resistor. The "eye" is usually tapped down on the diode lead resistor. The A.V.C. should be removed from the converter and I.F. stage by grounding or breaking the A.V.C. network at a point between the diode load and the isolating resistors.

No provision is made for attenuators on R.F. All that is necessary to reduce the volume is to loosen the coupling. This is done simply by placing the probe on the insulation instead of making direct contact. Intermediate frequency and oscillator signals can be picked-up several inches away from the tube socket.

(Continued on page 475)

**Conclusive Testing**



**MODEL 1213**

**\$22.00** Dealer Net

- Exclusive Handy Hinged Postcard Reference Tube Chart
- Filament Voltages from 1.1 to 110
- RED • DOT Lifetime Guaranteed Instrument
- Neon Shorts Test

Model 1213 contains all sockets to test all present day tubes including Pilot Lamps and Gaseous Rectifiers. Ballast Tube Continuity Test . . . Has separate line voltage control meter . . . Housed in snappy appearing metal case with brown suede baked enamel finish. Three-tone panel is brown, tan and red with silver markings.

Dealer Net Price . . . . . **\$22.00**



**MODEL 1612**

Impressive Counter Tube Tester. . . . RED•DOT Lifetime Guaranteed Instrument with 6" GOOD — BAD Scale. Illuminated Speed Chart . . . Sockets include Loctals, Bantam Jr.,

and new Midgets. Provision for tubes with filament voltages from 1.1 to 117 volts . . . Dealer Net Price . . . . . **\$29.84**

MODEL 1620—This is a counter type, lever switch operated tube tester. Four "quick-change" non-obsolete features, including RED•DOT Lifetime Guaranteed Instrument, Speed Roll Chart, New Socket Panel and Switching Section can all be replaced should unanticipated changes make it necessary. Dealer Net Price . . . . . **\$37.84**

MODEL 1621—Similar to Model 1621, but contained in smaller, more portable case . . . Dealer Net Price . . . . . **\$34.84**

Write for Catalog—Section 162 Harmon Avenue

**THE TRIPLET ELECTRICAL INSTRUMENT CO.**  
Bluffton, Ohio

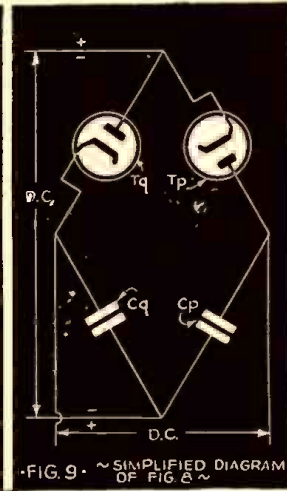
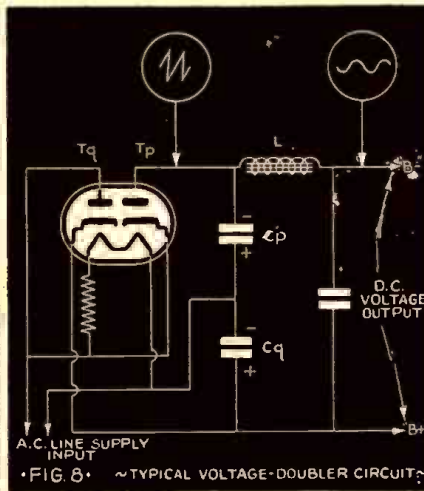
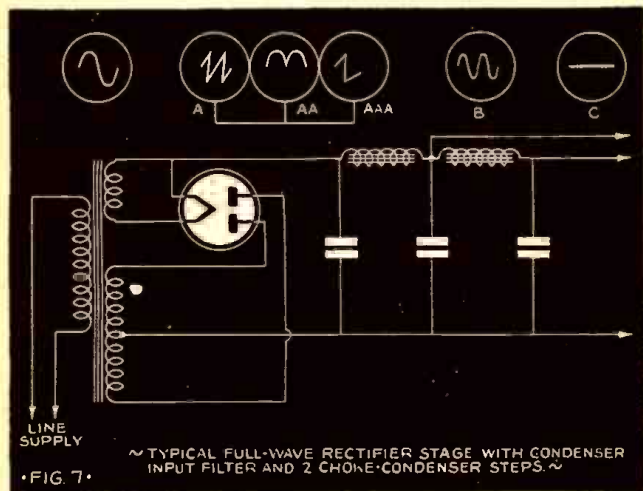

## VISUAL DYNAMIC SERVICING

In the following discussion, the 2nd and concluding section in a series, the author explains the applications of a visual dynamic analyzer in the servicing of modern radio receivers.

B. O. BURLINGAME

PART II (Conclusion)

THE voltages to be found in power supplies are 1st, the D.C. output voltage, and 2nd, any hum or ripple voltage. Thus in testing power supplies the D.C. voltmeter section and the low-frequency (A.F.) amplifier and oscilloscope section are used for these tests.

Connect the A.F. probe to the A.F. plug and switch-in the low-gain amplifier. The multimeter section of the dynamic analyzer should be set up for D.C. volts and regular test leads connected to the voltmeter terminals. The sweep oscillator on the dynamic analyzer should be adjusted to 1 cycle with line voltage applied to the probe.

### CHECKING "A," "B" AND "C" BATTERIES

There are a great many rural sections which do not have access to the power facilities found in the average municipality, and thus the filament and anode potentials are supplied from batteries. In the past few years there has been a growing demand for the portable receiver which has increased the number of battery-type radio sets requiring service.

In order to determine the condition of any type of radio battery, the unit must be checked under the same load conditions as when connected to a receiver. The battery or cell under test should be connected to the receiver, or an equivalent load, and the voltage of each section measured with the D.C. voltmeter of the dynamic analyzer. The voltmeter on the dynamic analyzer draws practically no current, and consequently would not indicate the condition of the battery unless a definite load current is drawn from the battery under test.

The correct load for the "A" battery may be determined by adding the total amount of current drawn by the filaments and dividing into the no-load voltage. Load resistors = battery voltage/filament current. The "B" and "C" batteries are checked the same as the "A" batteries, under load conditions. The discard or reject voltage being generally considered as 30% below the normal voltage when new.

### CHECKING THE FULL-WAVE RECTIFIER AND THE BRUTE FORCE FILTER

The conventional full-wave rectifier circuit shown in Fig. 7 is very popular among radio manufacturers for receivers to be sold in districts which have alternating current. One of the chief advantages of this system is that the full-wave rectifier produces a ripple voltage of twice the frequency of the line voltage, which simplifies the filter network. This type of circuit usually consists of a power transformer, thermionic rectifier and a low-pass filter system.

In general, the results to be expected from such a power supply would be a D.C. voltage high enough to excite the various anodes and yet have a minimum A.C. component. The ideal situation would be to have a "no-hum" output such as that produced by batteries. Each filter section reduces the A.C. component and some minimum hum level must be established with respect to the number of filter sections. This information may be obtained by checking some of the popular models of receivers in your particular territory and recording this data for future use. If you do not have the data on a particular model, the following notes should prove of some value.

The amount of hum present at the output of a power supply depends upon the resonant frequency of the low-pass filter and the ability of the inductors to maintain their respective values with variations in the output load. A well-designed filter section in the average receiver will cause a decrease in the A.C. component of about one-thirtieth to one-fortieth (1/30 to 1/40) between the rectifier output and the 2nd filter section.

Referring to Fig. 7, we have a typical full-wave rectifier circuit with a brute force filter system. For the sake of comparison we have shown 2 complete filter sections, although the majority of the sets use only 1. In sets which utilize the dynamic speaker one of the filter chokes will usually be the speaker field coil.

Perhaps one of the most common troubles

in a power supply is the breaking down of the filter condensers, causing a reduced voltage at the output of the power system. This should be checked first by the usual voltmeter method starting at point "C" Fig. 7, and if low-voltage appears at this point, proceed towards the output of the rectifier, power transformer, etc.

If the trouble does not appear to be caused by a low voltage and the hum level appears to be above normal, the following check should prove helpful in locating the defective part. Set the dynamic analyzer up as an untuned signal tracer (function selector in gain position) and with the A.F. probe proceed as follows:

Starting at the output of the rectifier or filter input, point "A" represents the results to be expected if the condenser is effective on a condenser input filter system. If oscillogram AA appears on the screen when checking a condenser input system, the effect is the same as a choke input system which represents a low-value input condenser.

If the system is a choke input filter, AA represents the correct results and A would represent a shorted choke coil. The frequency in the choke input or condenser input should be equal to twice the frequency of the line supply. This will be represented by 2 waves on the scope. If only 1 wave appears, such as represented by figure AAA, the voltage should be checked at the plates of the rectifier for a possible open secondary or shorted tube. Point "B" should indicate a reduction in the A.C. voltage of about 30:1 and the voltage will be more of a sinusoidal form instead of the usual saw-tooth wave-shape.

Proceed to point "C"; the amplitude of the A.C. component should be very low or negligible, depending on the number of filter sections and the load.

### THE HALF-WAVE RECTIFIER AND BRUTE FORCE FILTER

The half-wave rectifier has come into prominence in the past few years due to the introduction of the small compact re-



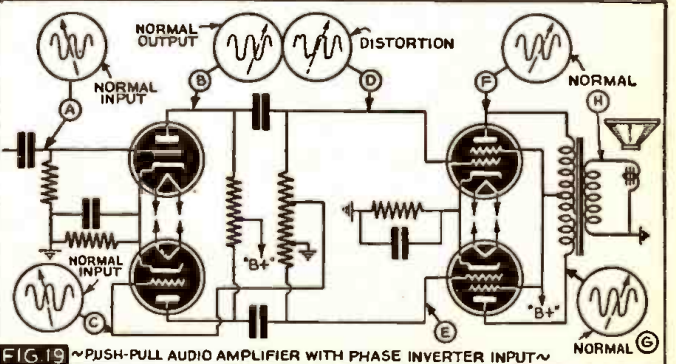
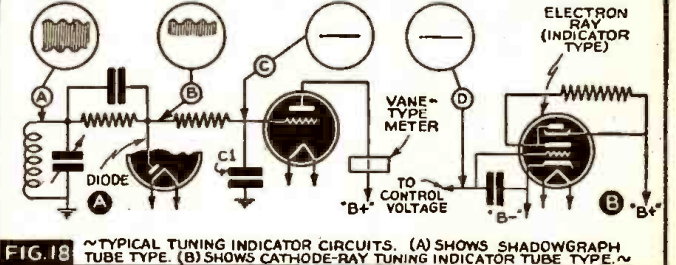
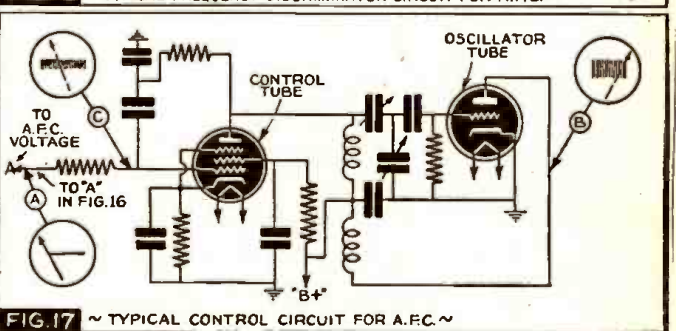
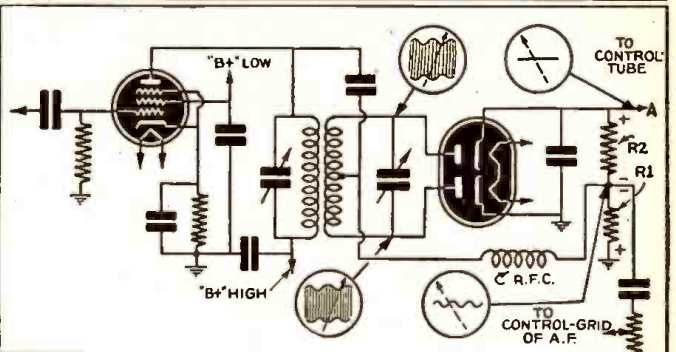
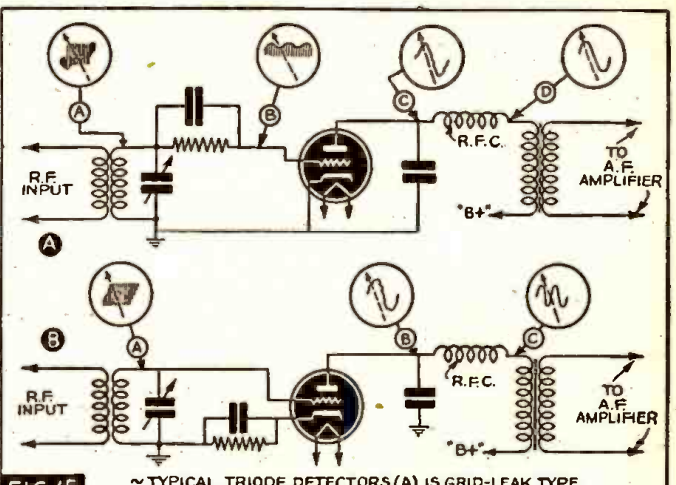
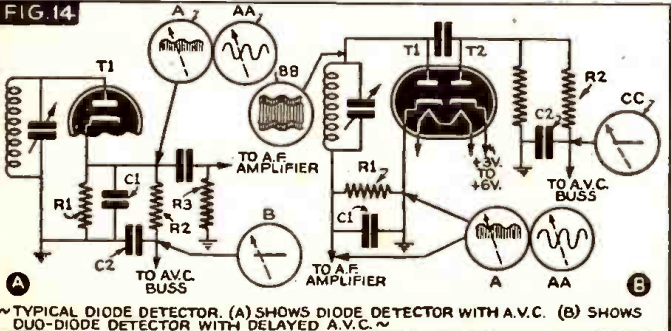
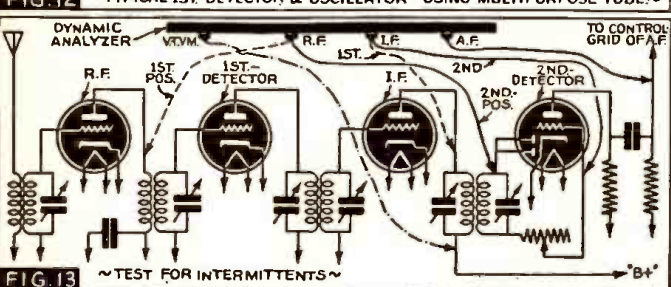
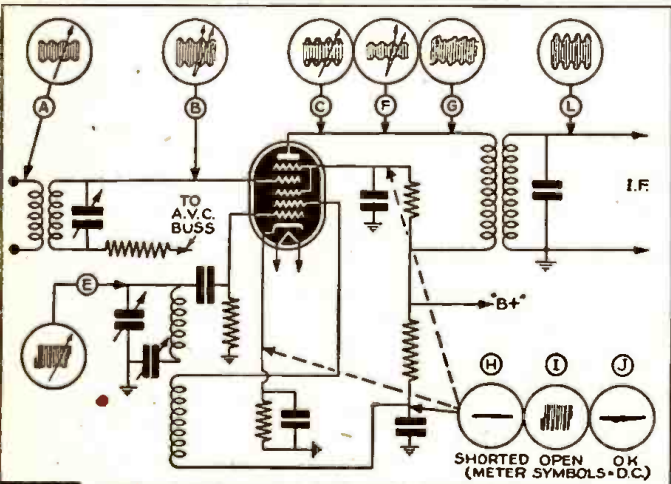
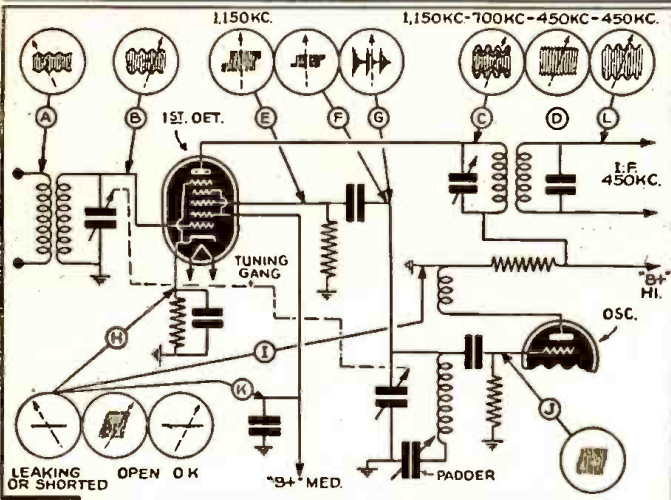
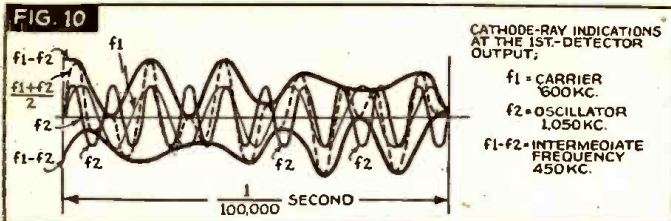

Typical circuit details of modern radio receivers which the Serviceman is called upon to diagnose and repair. The visual dynamic analyzer by enabling the Serviceman to actually SEE the signal cuts the time necessary to localize the receiver faults. The oscilloscopic patterns shown in the diagrams are pictures of the signal as it appears in various sections of a receiver circuit.

## SERVICING

A "LAB" to fit your pocket

Readrite  
RANGER

MODEL

739

\$9.90

Dealer Net Price

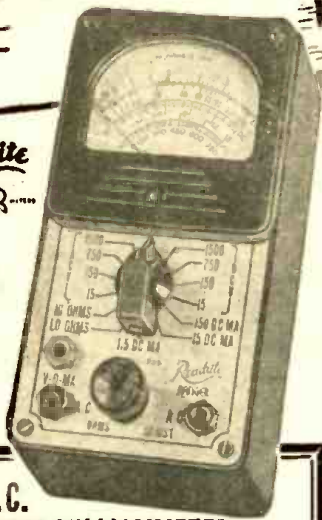

### A.C. D.C. VOLT-OHM-MILLIAMMETER

Pocket Volt - Ohm - Milliammeter with Selector Switch. Molded Case. . . . Precision 3-Inch Meter with 2 Genuine Sapphire Jewel Bearings. AC and DC volts 0-15-150-750-1500; DC MA. 0-1.5-15-150; High and Low Ohms Scales. . . . Dealer Net Price, including all accessories, \$9.90

MODEL 738 . . . DC Pocket Volt-Ohm-Milliammeter. Dealer Net Price . . . \$7.50

SECTION 216 COLLEGE DRIVE  
WRITE FOR CATALOG

READRITE METER WORKS, Bluffton, Ohio



**FREE!**

HAMMARLUND  
NEW "40"  
RADIO CATALOG

The latest Hammarlund catalog with complete data, illustrations, drawings and curves on the entire Hammarlund line. Address Department RC-2-1 for your free copy.

HAMMARLUND MFG. CO., INC.  
424-438 West 33rd Street, New York City

Simplest WAY TO REPLACE BALLASTS

4 STANDARD TYPES of Amperite Regulators replace over 200 types of

AC-DC Ballast Tubes now in use. . . . Has patented automatic starting resistor.

List \$1.00

WRITE FOR REPLACEMENT CHART "S"  
Amperite Co. 561 Broadway, N. Y. C.

**AMPERITE**

PATENT S—TRADE MARKS

Booklet concerning Inventions & Patents

Form "Evidence of Conception" with instructions for use and "Schedule of Government and Attorneys Fees"—Free

LANCASTER, ALLWINE & ROMMEL

Registered Patent Attorneys

436 Bowen Bldg. Washington, D. C.

ceivers and A.C.-D.C. sets. Frequently in very old sets we find the half-wave rectifier and sometimes we find the full-wave circuit using a double-half-wave circuit.

The transformerless A.C.-D.C. receivers use the half-wave rectifier circuits. The anode voltage supply is obtained directly from the line supplying a D.C. potential very close to that of the line when used with a condenser input filter system. The variation in this circuit from that of the transformer type of half-wave rectifier will be the absence of the transformer and an indirectly-heated cathode rectifier. One side of the line will form the negative return while the other side will be connected to the plate of the rectifier. As a rule, these small sets have the filaments of all of the tubes connected in series.

The results to be obtained with the half-wave circuit will be exactly the same as the full-wave rectifier with one side of the high-voltage winding open. This is represented by "AAA" in Fig. 7. Oscillogram "AA" of Fig. 7 illustrates the results to be expected when the first filter condenser is open or of low value, or the filter circuit is of the choke input type. The next points "B" and "C" indicate hum and no-hum, respectively.

### THE RECTIFIER - VOLTAGE DOUBLER CIRCUIT

The voltage-doubler - rectifier circuit has also become popular in the past few years due to the increased demand for an inexpensive, compact receiver. The chief advantage of this type of circuit is the ability of the circuit to produce a voltage equal to approximately twice that of the applied A.C. voltage without the use of a step-up transformer. A typical voltage-doubler circuit is shown in Fig. 8.

After looking at the circuit of the conventional rectifier systems which we have analyzed previously, the voltage doubler circuit has a complicated appearance. The diagram will be simplified somewhat if we draw it in the form of a regular half section of a bridge (Fig. 9) rectifier with the other half composed of 2 condenser capacities. When the plate voltage is positive with respect to cathode on Tq, condenser Cq charges to approximately the line voltage. On the remaining part of the cycle the voltage is rectified through Tp and charges Cp. In other words, Cq and Cp are charged alternatively and discharged into the load in series. The waveform at the output of the rectifier will be identical to that of the full-wave rectifier with a condenser input filter. The voltage output depends upon the capacity of Cq and Cp, the D.C. load, and the condition of the rectifier tube. The voltage output-load current curve is practically a straight line using condensers of from 20 to 30 mf. each. Roughly the no-load voltage should be about 2.3 times the input A.C. voltage and the full load voltage will be approximately 1.8 times the A.C. input voltage. Of course, these voltage measurements must be made at the output of the rectifier and will be greater than measurements at the end of the filter section due to the drop across the filter choke.

In most of the small, compact receivers the half-wave rectifier is used and the A.C. input circuit is very similar to that of the voltage doubler. Due to the inexpensive construction, the filter circuits of both the voltage doubler and the half-wave rectifier have about the same action on the screen of the cathode-ray oscilloscope. The chief difference will be the frequency of the D.C. impulses which is twice that of the line in the case of the voltage doubler and equal to that of the line in the case of the half-wave rectifier.

### CHECKING POWER SUPPLIES WHICH UTILIZE VIBRATOR UNITS

The popularity of the vibrator in automobile power supply units has widened its application to household receivers and aviation radio. When this device was first introduced in automobile receivers, it was built into the set, thus making replacements difficult due to the mechanical arrangement of this section. The time required to obtain an exact duplicate replacement part brought about an attempt to make the repairs in the service shop without the aid of the special equipment which was used in the manufacturing of the device.

Since the introduction of the vibrator, this handicap has been removed by making the part a plug-in device, thus facilitating replacement. The cathode-ray oscilloscope may be used to check the overall output of the vibrator. However, radio engineers do not recommend its use in checking mechanical device components of the vibrator. This is one of few parts in a radio receiver that presents more mechanical trouble than it does electrical failures. Many Servicemen have come to the conclusion that it is far more economical and practical to replace the vibrator rather than try to localize the trouble and attempt to repair it.

### CHECKING SUPERHET. OSCILLATOR

The oscillator and 1st-detector circuits constitute the chief difference between the superheterodyne and tuned-radio-frequency receivers. Many Servicemen of the old school have let this section give them a nice workout, especially in cases of distortion caused by the 1st-detectors.

Shortly after the advent of the superheterodyne came the multipurpose tube which added confusion as to the operation of the circuit. The 1st-detector and oscillator circuits are often referred to as converters, mixers, and translators, thus the new Servicemen are in the dark as to what really happens. The cathode-ray tube indicates the changes *step by step* and shows that there is actually a rectifier circuit preceding the intermediate frequency or I.F. stage and should be treated as a detector.

Let us review the theory of beat frequencies in order that we will know what to expect on the cathode-ray tube screen. It can be easily proven by trigonometric functions that when 2 voltages of different frequencies are placed in series, the resulting voltage will oscillate at the mean frequency (one-half the sum), while the amplitude varies at the difference between the frequencies. By drawing 2 sets of sine waves of different frequencies, or periods, this principle can be readily illustrated as in Fig. 10.

The waveforms in Fig. 10 were spread out in order to see exactly how the difference was accomplished. You will observe that the sum of the amplitudes results in making both the average and beat frequencies. The time base (1/100,000) would be the equivalent of adjusting the sweep oscillator on the dynamic analyzer to 100,000 cycles per second if such were possible. The upper frequency limit of the average oscilloscope is about 30 kc.

It is apparent that if we want to obtain the difference (F1-F2) we must rectify the signal, therefore, we go back to the days of single-purpose tubes and we have a reason for the common term, "1st-Detector."

Though fewer sets use a separate tube as the detector, we find many cases of separate oscillator. This is illustrated in Fig. 11. In the results with the oscilloscope, we have indicated how the signal will look with the 3rd or modulation voltage.

## GREAT NEWS!! . . . THE NEW **UTILITY TESTER**



The Utility Tester is a new kind of instrument for testing all electrical appliances—WASHERS, IRONERS, REFRIGERATORS, RANGES, VACUUM-CLEANERS, TOASTERS, PERCOLATORS, HEATERS, SUN LAMPS, AIR-CONDITIONING, MOTORS, etc. The Utility Tester enables every possible measurement necessary to service any electrical appliance.

Mr. Radio Serviceman, here is a new source of revenue for you. The UTILITY TESTER will enable you to accept and economically service electrical and industrial jobs you have been compelled to pass up in the past. You already possess the fundamental electrical knowledge necessary to service electrical and industrial utilities, and now you can have the instrument which will enable you to apply this knowledge to a new and lucrative source of extra income.

### SPECIFICATIONS:

**3 WATTAGE RANGES:** A.C. AND D.C. 0-100 Watts, 0-1000 Watts, 0-5000 Watts. The UTILITY TESTER reads the actual wattage consumption of any appliance, motor, etc., while it is in operation. Thus you can actually prove to the layman the actual consumption of any appliance and compute the actual cost per hour operation, basing your calculation on the local current cost. This is a feature never before obtainable in any instrument selling for less than \$50.

**6 VOLTAGE RANGES:** A.C. AND D.C. 0-1 Volt, 0-10 Volts, 0-50 Volts, 0-100 Volts, 0-500 Volts, 0-1000 Volts.

**4 CURRENT RANGES:** A.C. AND D.C. 0-1 Ampere, 0-10 Amperes, 0-50 Amperes, 0-100 Amperes. As far as we know, no instrument selling for less than \$50 has ever enabled current measurements up to 100 Amperes. The UTILITY TESTER provides this service on both A.C. and D.C.

**2 RESISTANCE RANGES:** 0-300 Ohms, 0-3000 Ohms. The UTILITY TESTER reads all resistances commonly used in electrical appliances and in addition reads extremely low resistances. For instance, 1½ ohms appears on the center of the low ohms scale and resistances as low as 1/50th of an ohm are easily read. This is a feature never before obtainable in an instrument selling for less than \$50.

The Utility Tester comes complete with self-contained battery, test leads, and all necessary instructions.

Shipping Weight 11 lbs. PORTABLE COVER \$1.00 ADDITIONAL.

**\$10<sup>85</sup>**

**SUPERIOR INSTRUMENTS CO., 136 Liberty St., Dept. S.A., New York, N. Y.**

In order to save space in receivers, frequently a multi-purpose tube is employed as the oscillator and converter. This type of circuit is represented in Fig. 12 and the progression is similar to that of the former circuit employing the separate oscillator.

A represents the R.F. input (usually antenna transformer).

B indicates a gain due to the turns ratio and resonant effect of the secondary.

C indicates the presence of the intermediate frequency (I.F.) signal.

F and G of Fig. 12 and D of Fig. 11 show that the conversion was made with low amplitude, or distortion, respectively. If C represents a good clean signal proceed to point L, if not check at E for the voltage output of the oscillator. If the signal from the oscillator appears to be low or intermittent (as in F and G of Figs. 11 and 12), check the condensers as indicated by "H, I and K of Figs. 11 or 12." The arrows represent the respective amplitudes of the radio frequency signal.

### CHECKING INTERMITTENTS

One of the most difficult cases of trouble to be found in a radio is the "intermittent." The very nature of the word indicates why this type of trouble in a radio receiver can cause hours of worry and frequently a financial loss on a service job. As long as the set is operating normally it is evident all of the components are temporarily OK, thus would not reveal the defect. Sometimes we can disturb a circuit and make the trouble appear, but more often we have to wait patiently for operation of the receiver to become abnormal.

The time required to trace down and eliminate the "intermittent" has been greatly decreased by the dynamic analyzer. The dynamic analyzer set up for this type of

analysis is shown in Fig. 13. All of the probes are used in order to monitor as many circuits as possible, thus making it easy to localize the trouble when the effect of the faulty part appears.

The regular D.C. voltmeter test lead should be connected to the output of the power supply so that a failure at this point may be checked when the trouble develops. The R.F., I.F. and A.F. probes should be connected to the various stages or sections of the receiver as indicated in Fig. 16. The procedure is as follows: Connect the R.F. probe to the stage of the oscillator variable condenser. Place the I.F. probe on the input of the I.F. amplifier. The A.F. probe should be connected to the output of the audio section.

When the trouble appears switch in the R.F., I.F. and A.F. sections consecutively and observe the 'scope. If the signal fails to appear upon the cathode-ray screen your trouble is between the place where the signal was present and where it did not indicate. One should not neglect to observe the meter monitoring the power supply which may indicate that the trouble is in this section. Furthermore, if you note that the trouble has appeared and the power supply is still producing the desired output, the function selector switch may be rotated to Wavemeter position and the meter used in conjunction with the 'scope.

After the trouble has been localized to some particular section the rest is simple signal tracing. Frequently signal tracing will locate the intermittent as it indicates where the signal stopped.

Let us take a particular case such as that illustrated in Fig. 13. The probes are attached to the defective receiver as indicated by the dotted lines. Now let us suppose the signal cuts out, distorts or reduces in

volume. Checking the 1st and 2nd channels indicates the signal is normal at these points. Upon switching in the A.F. section we find no indication on the screen. Evidently the trouble is between the connections of the I.F. and A.F. probes. Now to close-in on this case of trouble, we place the R.F. and I.F. probes as indicated by the solid lines and repeat the procedure when the set fails. No indication on the A.F. section with these connections indicates the trouble is either a defective tube or a bad coupling condenser between the 2 audio stages.

### MAKING GAIN MEASUREMENTS

In order to measure the gain of an A.F., R.F. or I.F. amplifier, the following procedure should be followed. With the function control of the Dynamic Analyzer set for gain and using the R.F. probe on the input of the stage to be tested, rotate the vertical gain control until the meter indicates approximately one-half scale deflection. Observe the multiplier buttons and vertical gain. Next, place the probe on the output of the stage or stages to be checked and push the switch buttons and rotate the vertical gain until the former deflection of the meter is obtained. The gain is equal to the ratio of the first setting of the vertical gain and multiplier, to the last setting or vice versa if there is a loss.

As an example, suppose that we place the probe on the input of the 1st I.F. stage in a superheterodyne and obtain half-scale deflection by depressing the "1" button with the vertical gain set at 50. At the input of the 2nd stage, say that we have to depress the 100 button and rotate the vertical gain to 25. The gain is then represented by 50 (50 x 1) to 2,500 (25 x 100) or 1:50.

(Continued on following page)

# SERVICING



## DUAL DANDEES ... with four leads

- To those already sufficient reasons—compactness, convenience, economy—Aerovox now adds the widest choice of values and combinations in rounding out its line of midjet electrolytics. Latest additions are the Dual Dandees with separate sections and four leads (Series PRS-B), and with concentrically-wound sections with three leads (Series PRS-A), 25 to 450 v. D.C.W. 8-8 to 20-20 mfd.

### Ask Your Jobber...

- He can show you these latest midjet electrolytics. Try a few. Ask for latest catalog—or write us direct.

**AEROVOX**  
CORPORATION  
NEW BEDFORD, MASS.  
IN CANADA: AEROVOX CANADA Limited, Hamilton, Ont.

**RADIO** **EVERYTHING IN RADIO**

This one big book serves your entire radio needs. It includes sets, parts and supplies, public address systems, amateur equipment, testers, kits and fluorescent lighting. You'll find the nationally known favorites at the lowest possible prices. Get your copy of this big FREE CATALOG today.

**BURSTEIN-APPLEBEE COMPANY**  
1012-14 McGEЕ STREET, KANSAS CITY, MISSOURI

Servicemen! Radio Technicians! Engineers! Get the bigger and better Sylvania Technical Manual . . . 264 pages of vital tube information—complete data and diagrams for 344 types of tubes. Gives operating conditions, characteristics and circuit applications for standard glass tubes, "G," "GT," Loktal, Metal, Majestic and special types. Data on television amplifiers, cathode-ray tubes, etc. Send 35c for your copy today. Hygrade Sylvania Corp., Dept. RC21, Emporium, Pa.

**SOLAR RED-CAPS**  
Smaller Diameter Dry Electrolytics  
**SPEED Servicing**  
Write for Catalog  
**SOLAR MFG. CORP. Bayonne, New Jersey**

## CHECKING DEMODULATORS (DETECTORS) OF RECEIVERS

In order to extract the audio component from the R.F. signal from the previous I.F. or R.F. stage some form of rectification must be employed. The process of rectifying the radio frequency signal and filtering-out the high-frequency current is called *detection*.

There are several types of detectors employed in performing this function and each has its particular properties as well as its effect upon the cathode-ray-tube screen.

**Diode Detectors.**—This type of rectifier or detector is perhaps the most popular in modern receivers due to its ability to produce linear rectification. It may also be said that it is one of the most simple types of detectors as well as being one of the first types used in the commercial radio receiver.

Figure 14A illustrates a typical diode detector circuit which you will observe is similar to the half-wave rectifier. The modulated signal on the secondary (A) of the R.F. or I.F. transformer is rectified by the tube T1 and the resulting audio component is developed across resistor R1. (B) Filter C1 tends to reduce the high frequency to approach that of "AA". Resistor R2 in series with C2 serves to filter out most of the remaining A.F. and should indicate a steady D.C. potential regardless of the audio variation, except on low-frequency modulation.

Figure 14B illustrates a diode detector and also an additional diode which is utilized for delayed A.V.C. The only difference between this type of circuit and the one discussed previously is that a D.C. compensating voltage is introduced in the A.V.C. rectifying section to prevent rectification and A.V.C. action when a small R.F. signal is present. The results on the 'scope are the same as in the case of the former A.V.C. circuit and the oscillograms A, B and C indicate the respective points. The bias cell or supply proving the compensating voltage should be checked with the regular external D.C. V.-T. Vm. T1 and T2 are usually included in a single envelope such as duodiodes 6H6, etc.

**Triode Detectors.**—When the tuned-radio-frequency receiver was at the height of its popularity, the triode detector was usually employed. This particular type of detector gives some amplification, however, we frequently find distortion at the output due to the non-linear rectifying characteristics. Figure 15A illustrates a typical grid-leak detector and the result to be expected upon the cathode-ray-tube screen. Rectification takes place in the grid circuit similar to that in a diode detector as shown at B; C and D indicate the results in the plate circuit before and after it has passed through the R.F. filter choke (R.F.C.). Figure 15B illustrates what the operator should expect when checking a detector of the bias type.

## CHECKING RECEIVERS WITH A.F.C. CIRCUITS

Figure 16 represents a typical discriminator circuit which is employed to convert intermediate frequency variations (due to the frequency drift of the oscillator in a superheterodyne receiver) into D.C. voltage changes, which are in turn applied to the grid of the oscillator control tube.

This is accomplished by using a duodiode detector with signals of equal strength applied to its anodes when the oscillator of the receiver is tuned to the proper frequency. When there is a shift in the frequency of the oscillator, the voltage on the plates of the rectifier are of different amplitude and in turn produce a change in the voltage across the discriminator load re-

sistors R1 and R2. The measurement at this point is exactly the same as described for A.V.C. voltage measurement.

## CHECKING THE OPERATION OF THE FREQUENCY CONTROL TUBE

A typical control tube circuit is shown in Figure 17. To check its operation the following measurements should be made with the dynamic analyzer.

1st.—As in A.V.C. voltage measurements connect the D.C. vacuum-tube voltmeter in the dynamic analyzer to the A.F.C. control voltage buss in A of Figure 17.

2nd.—Connect the R.F. probe to points B or C of Fig. 17 and with the aid of the wavemeter determine the frequency of the oscillator when the receiver is manually tuned to the signal frequency of the signal generator output.

Then as the receiver is detuned slightly from the signal in both directions there should be a shift in the amplitude and polarity of the D.C. control voltage on the control tube. This shift in control voltage should automatically return the oscillator frequency to the same frequency as measured on the wavemeter in the 2nd operation above.

In testing tuning indicator circuits, set the dynamic analyzer in position for signal tracing and check points A, B and C as shown in Fig. 18. A should indicate the presence of the modulated signal, B the rectified envelope and C should indicate an approximately straight line on the 'scope. Condenser C1 should tend to prevent the audio variations; the resultant D.C. voltage at Point C may be checked in the same manner as the A.V.C. voltage. This D.C. voltage is usually applied to the terminals of a tuning indicator tube operating one of the many tuning indicator meter devices or it may feed the control-grid of a cathode-ray tuning type tube as shown at D, in Fig. 18B.

## CHECKING A.F. AMPLIFIERS

In testing audio frequency amplifiers the dynamic analyzer should be set up for gain and the same procedure followed as described in testing the gain of R.F. and I.F. amplifiers. In this case an audio voltage should be applied to the input of the amplifier (supplied by the detector in radio receivers when using a modulated R.F. signal). The operator should observe the waveform and amplification at the input and output of each stage, using the A.F. probe of the dynamic analyzer.

In this manner the stage in which distortion starts may readily be determined. Also if excessive hum is present in the A.F. system the circuit in which the hum originates may quickly be determined and a remedy applied.

If the circuit of an A.F. stage is oscillating this will be indicated by a signal which will be visible on the oscilloscope screen but which will not decrease when the signal generator input to the system is decreased.

Figure 19 shows a typical audio amplifier and the points A to H indicate the successive points at which the amplitude and waveform should be checked.

## VISUAL ALIGNMENT WITH THE 'SCOPE

After the trouble in the receiver has been located and corrected, most Servicemen find it necessary to realign the I.F. and R.F. sections and adjust the frequency of the oscillator for proper tracing. Sometimes the sections are found to be far out of adjustment, usually caused by the hands of the owner or "neighborhood genius," but more often we find the cause is natural capacity drift produced by temperature, etc.

The 'scope section of the dynamic analyzer

may be used to advantage at this point since it is the fastest method of accurate alignment known today. If the receiver is small and does not contain wide band-pass intermediate frequency transformers, then peak or adjust the stages for maximum amplitude. In a receiver of this type it would be a waste of time to try to secure high-fidelity performance and to adjust for a corresponding selectivity. In receivers designed for high-fidelity reception, more care should be exercised to see that the stages are adjusted to the proper band width as well as maximum amplitude. Usually manufacturers supply the alignment curve and this should be duplicated as closely as possible.

In general, connect the vertical input of the 'scope to the output of the 2nd-detector and apply a frequency-modulated signal to the input of the amplifier to be aligned. When adjusting the intermediate frequency amplifiers connect the signal generator to the input of the 1st-detector and for adjusting the R.F. and oscillator make the connections to the antenna. In any event, the 'scope must receive a rectified signal to produce a conventional resonance curve.

We will not attempt to discuss the various types of resonance curves as this subject has been in print many times before. Full details may be obtained from the instruction sheets of any signal generator which has facilities for visual alignment.

This article has been prepared from data supplied by courtesy of Supreme Instruments Corp.

Servicemen and other Radio-Craft readers are requested to send in their suggestions of topics, not covered in articles published within the last 12 months, about which they would like to see discussions in forthcoming issues of Radio-Craft. These suggestions may embrace both theory and construction stories.—Editor

**GHIRARDI FLIES TO FINISH NEW BOOK**



Alfred A. Ghirardi, prominent author of some of radio's most outstanding text books rides the airways to finish a new one. Shown here boarding the American Airlines Flagship at the new LaGuardia Airport for a rush trip to visit service shops and radio manufacturers in the Buffalo-Detroit-Chicago area to get last-minute receiver servicing data for the new 2nd Revised Edition of his RADIO TROUBLE-SHOOTER'S HANDBOOK which is to be published next month. A.G.'s a busy man these days!

**BUY DIRECT FROM THE MANUFACTURER AND SAVE**

**THE NEW MODEL 1240**

**TUBE TESTER**

- Instantaneous snap switches reduce actual testing time to absolute minimum.
- Tests all tubes 1.4 to 117 volts.
- Sockets for all tubes—No Adapters.

Superior is proud to offer the newest and most practical tube tester ever designed. Unbelievably low in price—unbelievably high in performance.

- ★ Tests all tubes, 1.4 to 117 Volts. Including 4, 5, 6, 7, 7L, octals, loctals, Bantam Jr., Peanut, single ended, floating filament, Mercury Vapor Rectifiers, the new S series; in fact, every tube designed to date.
- ★ Spare socket included on front panel for any future tubes.
- ★ Tests by the well-established emission method for tube quality directly read on the GOOD ? BAD scale of the meter.
- ★ Jewel protected neon.
- ★ Tests shorts and leakages up to 2 meg-ohms in all tubes.
- ★ Tests leakages and shorts in all elements AGAINST all elements in all tubes.
- ★ Tests BOTH plates in rectifiers.
- ★ Tests individual sections such as diodes, triodes, pentodes, etc., in multi-purpose tubes.
- ★ Latest type voltage regulator.
- ★ Features an attractive etched aluminum panel.
- ★ Works on 80 to 125 volts 60 cycles A.C.

Model 1240 comes complete with instructions and tabular data for every known type of receiving tube. Shipping weight 12 pounds. Size 6" x 7 1/4" x 10 3/4". Our Net Price

Portable cover \$1.00 additional

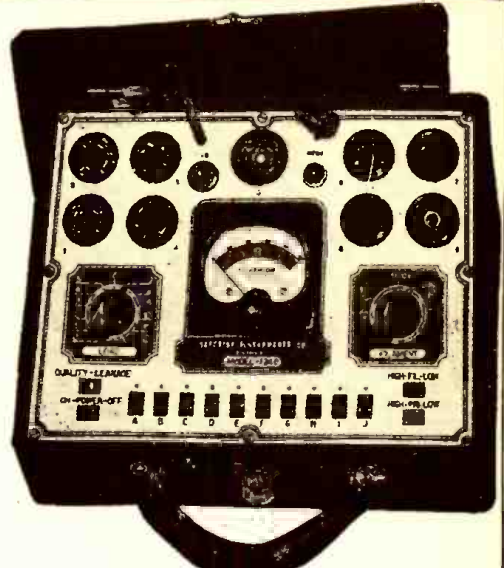

**\$11<sup>85</sup>**

**THE NEW MODEL 1230 SIGNAL GENERATOR WITH FIVE STEPS OF SINE-WAVE AUDIO**

**SPECIFICATIONS**

**RADIO FREQUENCIES:** from 100 K.C. to 90 Megacycles in 7 bands by front panel switch manipulation. All direct reading and accurate to within 1% on I.F. and Broadcast bands, 2% on higher frequencies. The R.F. is obtainable separately or modulated by any one of the five Audio Frequencies.

**AUDIO FREQUENCIES:** 5 steps of SINE-WAVE audio 200, 400, 1000, 5000 and 7500 cycles WITH OUTPUT OF OVER 1 VOLT. Any one of the above frequencies obtainable separately for servicing P.A., hard-of-hearing aids, etc.

**ATTENUATOR:** Late design, full-range attenuator used for controlling either the pure R.F. or modulated R.F.

**CIRCUIT:** The Model 1230 employs an improved electron coupled oscillator circuit for the R.F. affording positive protection against frequency drift and a Hartley oscillator circuit for the A.F. section.

**DIAL MANIPULATION:** Large 5 1/4" dial etched directly on front panel, using a new mechanically perfected drive for perfect carrier control.

**APPEARANCE:** The front panel is etched by a recently perfected process which results in a life-long attractive finish and the instrument comes housed in a streamlined shielded cabinet.

**CURRENT SOURCE:** The Model 1230 operates on 90 to 120 volts A.C. or D.C. any frequency.

The Model 1230 comes complete with tubes, shielded cables, moulded carrying handle and instructions. Size 14" x 6" x 11". Shipping weight 15 pounds. **ONLY \$12<sup>85</sup>**

**SUPERIOR INSTRUMENTS CO. 136 Liberty St., Dept. S.A. NEW YORK, N. Y.**

**MODERNIZE YOUR OLD TESTERS!** In the next issue a fellow Serviceman describes how he modernized his and shows how you can do likewise with yours. It's an important article, so don't miss it.

**RADIO SET TO TEST RADIO SETS**

(Continued from page 469)

**ADDING V.-T. V.M.**

The grid of the tuning indicator can be run to one side of an additional S.P.D.T. switch so that it is available for making A.V.C. measurements, or as an output indicator. Likewise any one of the many electronic and vacuum-tube meters that have appeared in this and other publications may be used in connection with the gadget. Simply connect to the diode through a 0.5- or 1-meg. resistor for R.F. indications; and through a 1-meg. and a 0.05-mf.

condenser to the plate of the output, tube for A.F. indications.

The gadget should be carefully shielded for best performance. Where powerful local stations have to be tolerated, the inputs may have to be grounded in unused positions. To go into great detail on the construction would require more space than is available here, but the author will be glad to answer correspondence addressed to him in care of this magazine. (Please enclose stamped and return-addressed envelope.)

RCA VICTOR MODEL BT-42 BATTERY RECEIVER (Chassis No. RC-408A)

4-Tube Superhet.; Battery Operation; Broadcast Band (Range 540 to 1,720 kc.); Automatic Volume Control; 1.4-V. Low-drain Tubes; "Economy" Blinker; Magnetite-core Transformers; PM Dynamic Speaker; Power Output (max.) 0.25-W. (A converter unit is available to permit operating this set on 115 V., A.C.)

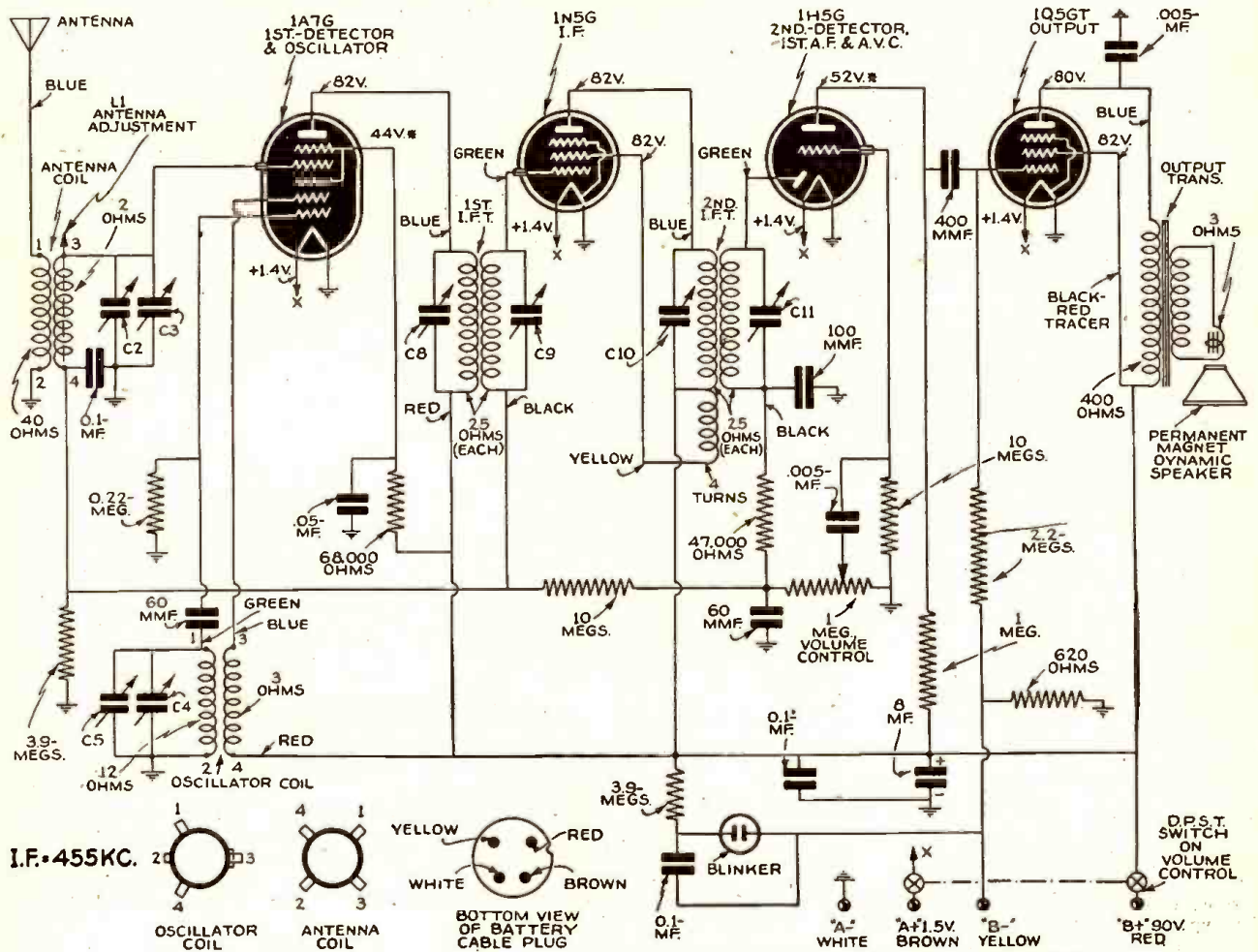

Complete schematic diagram of the RCA Victor Model BT-42, Battery-operated Superhet., Chassis No. RC-408A.

ALIGNMENT PROCEDURE

**Output Meter Alignment.**—If this method is used, connect the meter across the voice coil, and turn the receiver volume control to maximum.

**Test-oscillator.**—For all alignment operations, keep the output as low as possible to avoid A.V.C. action.

**Pre-setting Dial.**—With the gang condenser fully out of mesh, the indicator should point to the extreme right (high-frequency) mark on the dial scale.

**CAUTION.**—When ready to install or re-

place batteries or tubes or to make any repairs or changes, be sure to turn off power switch.

Precautionary Lead Dress.—

1. All filament (brown) and "B+" (red) leads must be dressed away from unshielded I.F. coil.
2. Green grid lead of 1A7G tube to be twisted around antenna (blue) lead for capacity coupling.
3. Red and brown battery cable leads to be dressed and held against front apron with tape.

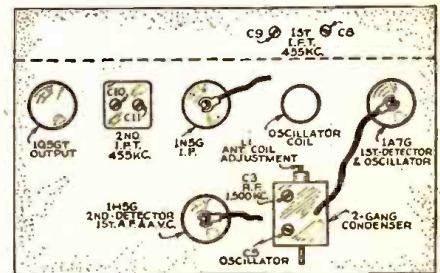

Locations of main components and trimmers.

| Steps | Connect the high side of test-oscillator to—    | Tune test-osc. to— | Turn radio set dial to—            | Adjust the following for max. peak output—       |
|-------|---|--------------------|------------------------------------|--|
| 1     | 1A7G 1st-Det. grid cap, in series with 0.01-mf. | 455 kc.            | Quiet point at 550 kc. End of Dial | C8, C9, C10, C11 (1st and 2nd I.F. transformers) |
| 2     | Antenna lead                                    | 1,500 kc.          | 1,500 kc.                          | C5 (oscillator)                                  |
| 3     | (blue) in series with 100 mmf.                  | 600 kc.            | 600 kc.                            | L1 (antenna)*                                    |
| 4     |   | 1,500 kc.          | 1,500 kc.                          | C3 (antenna)                                     |

\*When adjusting L1 (antenna), trimmer C3 should be in a minimum capacity position (unscrewed).

The "A" consumption is 0.24-A.; "B", 10 ma. An Eveready No. 748, or equivalent; "A-B" pack is used.

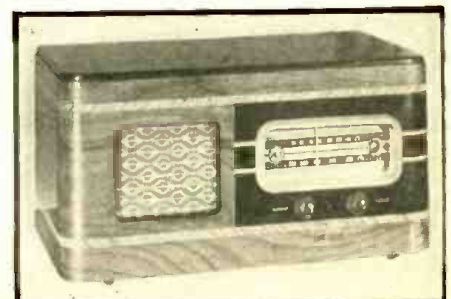

RCA Victor Model BT-42, Table Model, Portable Battery-operated Superheterodyne Receiver.

## OPERATING NOTES

### Trouble in . . .

#### . . . WESTINGHOUSE 272

Intermittent loss of sensitivity. To test, put volume control at maximum, feed weak signal from generator to antenna input and wiggle 2nd I.F. transformer, checking for loose leads or connections. Also, check trimmers in this unit for any possible irregularity. Probably, replacement will be needed.

#### . . . WESTINGHOUSE PORTABLE MODEL 675

If dial slips, which is very common, remove dial assembly and take off the cable where it winds around the shaft on which the dial knob fits. The trouble is not enough friction between cable and shaft, so with a file roughen-up the shaft slightly, then powder with resin obtainable from the hardware store. This will result in a better operating dial. Do not, if you will save time, try to use any cable thicker than the one which comes as original equipment.

WILLARD MOODY,  
New York, N. Y.

#### . . . RCA 46X3 (Chassis 459B)

In servicing an RCA model 46X3, chassis No. 459B, I was misled into thinking that the heaters in all the tubes were not open because the pilot light was illuminated. In this set the ballast tube (or plug-in resistor) has the sole function of dropping the voltage for the dial lamp, and when it is functioning the dial lamp lights though all the tube heaters are burned-out. Aside from being confusing to the Serviceman, this circuit is objectionable in that it uses as much electricity for the pilot lamp as for the heaters of all the tubes and defeats the purpose of the low-current tubes, which was to decrease the amount of heat dissipated in the radio set. This almost doubles the cost of operating the set. If the ballast tube should burn out I would rewire the pilot lamp to the heater tap on the 35Z5GT, which is not used on the original set-up.

ROBERT F. WALLACE, Ph.D.,  
Instructor in Radio Repairing,  
Columbus, O.

#### . . . PHILCO 60

Bad hum which stops when volume control is retarded—is due to open 0.05-mf. condenser. This is the one with green lead from the condenser block to the plate padding condenser of the 6A7. Replace with 600-volt unit.

#### . . . PHILCO 59

Over-all oscillation in this model is often due to open bypass from "B" to chassis. This is a 0.015-mf. condenser, part of a dual, located next to the wire-wound resistor in the corner.

When oscillator frequency shifts, detuning the signal, replace the bypass condenser on the screen-grid of the det.-osc. with a 0.1-mf., 600-volt. This condenser is located in back of the type 42 tube, and is the bottom terminal, on the second one from the side.

#### . . . GENERAL ELECTRIC A82

Trouble—primary of push-pull transformer open. When set is wanted without waiting for replacement, capacity-couple the 6C5 to the control-grid of one of the 6F6s. Use 0.1-mf., 600-volt condenser. Wire two 50,000-ohm resistors in series and bypass the common lead to ground with at least 0.25-mf., 600-volt. One resistor connects to the plate of the 6C5, the other connects to the positive terminal near the front of the set. Tests on V.-T.-Vm. show nearly perfect phase inversion, although the voltage on the 2nd grid is not quite as high.

This same arrangement will work on practically any push-pull transformer with a burned-out primary.

#### . . . PHILCO (GENERAL HINT)

All Philco's using a type 75 det.-1st A.F., biased by resistor, and using bakelite-encased condensers.

Where distortion is present at any setting of the volume control, check the plate bypass of the 75. This is connected between the 2 resistors in the plate circuit, and is part of a dual unit. A leaky condenser drops the voltage on the plate to a point where the plate current is practically cut-off, due to the bias.

(The contributor of these Notes failed to submit his name and address.)

#### . . . PHILCO 800

Inoperative or rattling sounds, caused by an open or short-circuited buffer condenser, often causes continued arcing of the vibrator points. Replace with a new unit. Another source of trouble is loose rivets; check these carefully and if impossible to re-rivet solder same firmly to the chassis.

(Continued on page 479)

YOU DON'T HAVE TO TALK

"Telephone Numbers"

when you buy

**RADIO CITY PRODUCTS**

dependable Test Equipment

HERE'S real high-accuracy test equipment—at prices within reach of every serviceman and experimenter. Unprecedented demand for RCP instruments has made such values possible by allowing us to take every advantage of economies resulting from quantity production. These savings are passed on to you in the form of better equipment at less cost.

Look over the specifications of these two instruments—see the wide range of measurements they give you, and note the rock-bottom prices. They are typical of the many other Radio City Products super-values.

### MODEL 446 AC-DC MULTITESTER

Here are the specifications of Model 446—Note the quality and performance RCP gives you for so little money.

- Bakelite case, 3-inch square D-Arsonval Meter, accurate within 2%
- DC volts 0/5/50/250/500/2500
- DC milliamperes 0/1/10/100/1000
- DC ammeter 0/10
- AC voltmeter 0/10/100/500/1000
- Ohmmeter 0/500/100,000/1 meg. will read as low as 0.1 ohm
- Four decibel ranges, -8 to +55



- Output meter, 4 ranges on AC volt scale
- Equivalent of 25 different instruments in single case with batteries
- Convenient selector switch operation, attractive panel case and multicolored dial
- Meter sensitivity 1 ma. full scale

DEALER NET PRICE **\$9.95**

### MODEL 702 SIGNAL GENERATOR

- Up-to-the-minute circuit and mechanical design
- Range 95 Kc. to 100 Mc. direct-reading. Continuously variable
- Unmodulated, or modulated 30% at 400 cycles
- 400 cycle output for external connection
- Provides for applying external modulation for use with oscilloscope
- Five-step calibrated attenuator ratio 1 to 500,000
- No dead spots, ripple, or feedback through line



DEALER NET PRICE **\$22.95**

FREE 1941 Catalog No. 124 describes the complete line of Radio City Products Test Equipment. WRITE FOR IT TODAY

**RADIO CITY**

PRODUCTS COMPANY, INC.

88 PARK PLACE • NEW YORK, N. Y.

**RCP**  
dependable  
**TEST**  
instruments

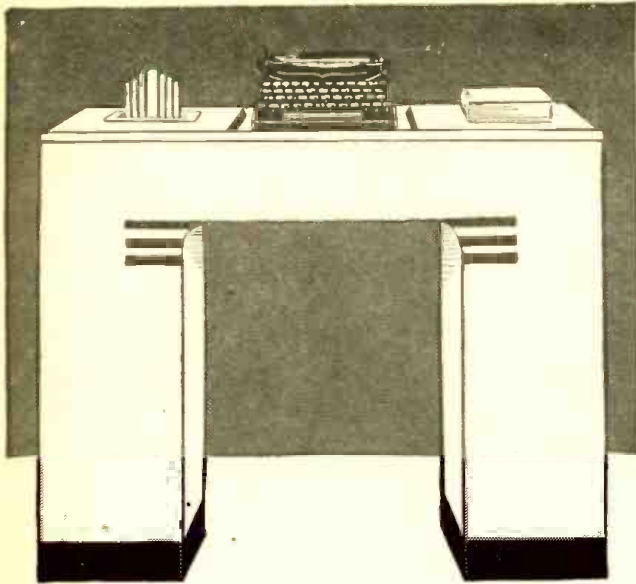

**THIS  
BEAUTIFUL DESK  
for only \$1.00 EXTRA**

**WITH ANY  
REMINGTON  
PORTABLE TYPEWRITER**

*The*  
**COMBINATION**  
FOR AS LITTLE AS  
**10¢ A DAY**

How easy it is to pay for this combination of desk and Remington Deluxe Noiseless Portable Typewriter! Just imagine, a small good will deposit with terms as low as 10c a day to get this combination at once! You will never miss 10c a day. Yet this small sum can actually make you immediately the possessor of this amazing office at home combination. You assume no obligations by sending the coupon.

A beautiful desk in a neutral blue-green which will fit into the decorations of any home—trimmed in black and silver—and made of sturdy fibre board—is now available for only one dollar (\$1.00 extra) to purchasers of a Remington Noiseless Portable Typewriter. The desk is so light that it can be moved anywhere without trouble—it is so strong that it will hold six hundred (600) pounds. With this combination of desk and Noiseless Deluxe Portable Typewriter, you will have a miniature office at home. Learn the complete details of this offer. Mail the coupon today.

**THESE TWO EXTRA FOR YOU**

**LEARN TYPING FREE**

To help you even further, you get free with this special offer a 32-page booklet, prepared by experts, to teach you quickly how to typewrite by the touch method. When you buy a Noiseless you get this free Remington Rand gift that increases the pleasure of using your Remington Noiseless Deluxe Portable. Remember, the touch typing book is sent free while this offer holds.



**SPECIAL CARRYING CASE**

The Remington Deluxe Noiseless Portable is light in weight, easily carried about. With this offer Remington supplies a sturdy, beautiful carrying case which rivals in beauty and utility the most attractive luggage you can buy.



**SPECIFICATIONS**

ALL ESSENTIAL FEATURES of large standard office machines appear in the Noiseless Portable—standard 4-row keyboard; back spacer; margin stops and margin release; double shift key and shift lock; two color ribbon and automatic ribbon reverse; variable line spacer; paper fingers; makes as many as seven carbons; takes paper 9.5" wide; writes lines 8.2" wide. There are also extra features like the card writing attachment, black key cards and white letters, touch regulator, rubber cushioned feet. These make typing on a Remington Deluxe Noiseless Portable a distinct pleasure. Thousands of families now using the Remington Deluxe Noiseless Portable know from experience how wonderful it is!

**MONEY BACK GUARANTEE**  
The Remington Noiseless Portable Typewriter is sold on a trial basis with a money back guarantee. If, after ten days trial, you do not wish to keep the typewriter, we will take it back, paying all shipping charges. You risk nothing in buying a Remington Portable Typewriter on terms as low as 10c a day.



**MAIL  
COUPON  
NOW!**

Remington Rand Inc., Dept. 189-2  
465 Washington St., Buffalo, N. Y.

Tell me, without obligation, how to get a Free Trial of a new Remington Deluxe Noiseless Portable, including Carrying Case and Free 32-page Typing Instruction Booklet on terms as low as 10c a day. Send Catalogue.

Name.....  
Address.....  
City..... State.....



(Continued from page 477)

.... ATWATER KENT 667

Cross-talk, oscillation, or weak reception, all may be caused by an open or leaky bypass condenser or an open-circuit in the 1st-detector cathode bias resistor. Sometimes it is also necessary to ground-bias the antenna to remedy cross-talk (this is the red lead).

.... ATWATER KENT 667-D OR 7-D

Low volume or oscillation in this model, may be due to a leaky condenser unit (part No. C-18). Replace this with a 8-mf., 600-volt one. Also look for an open-circuit I.F. transformer unit, T5; if such is found, do not repair, but replace with a new unit.

.... GENERAL ELECTRIC E-105

Distortion in this set was caused by a leaky coupling condenser to the grid of the 6L6 tube. Use a 600-V. replacement.

Another set of this same model came into the shop "dead." We found the 0.01-mf., 1,000-V. bypass condenser connected from the 6L6 plate to ground shorted, and replaced it with a 1,600-volt buffer condenser.

.... ZENITH 6D311

If the complaint is "noisy volume control", check for an open filter condenser before replacing the control. An open condenser, or one partially open, makes the set unstable, and magnifies any slight noise caused by the control.

.... PHILCO 118

An intermittent drop in volume, accompanied by a noticeable reduction of the high-frequency response, is usually caused by the tone compensating condenser, which is connected to the volume control slider, intermittently open-circuiting.

THOMAS PREWITT, Plainfield, Ind.

## USING THE VECTOR DIAGRAM IN RADIO

WILLARD MOODY

**V**ECTORS, lines drawn to indicate the direction and magnitude of an electrical or mechanical force, are very useful in getting a clear picture of what happens when those forces act together.

In A of Fig. 1, a line is drawn which shows that a force is acting in a negative

or downward direction, while figure B indicates a force acting to the right, along what is generally the "time axis"; C shows an upward or positive force, and D shows the relation existing in the equation for impedance of a coil. Since the line Z has a length equivalent to the algebraic sum of the lines X1, R, the relation is the same as in the equation and the unknown value can be determined by graphical means as well as by the mathematical equation.

In Fig. 1, the diagram D could also represent the effect present in the cathode-ray tube, where the R vector represents the voltage on the horizontal plates and X1 represents the voltage on the vertical plates. The net result is the vector sum of the 2 voltages, given by the line Z. As this line moves (varies in length) a curve is traced-out on the fluorescent screen of the cathode-ray tube.

At E in Fig. 1, it is seen that X1 or inductive reactance is positive, while in the same figure Xc is drawn with a downward direction line to show that it is negative.

In an electric wave, as shown in Fig. 2, the vector is also used to show voltage intensity and position.

In Fig. 3, the action of the discriminator transformer in an A.F.C. (or in a Frequency Modulation detector) circuit is graphically depicted by the vector diagram. The frequency to which the primary L/C circuit is tuned is fr. Coils L1 and L2, being of opposite phase, cancel-out at resonance. However, a shift to above or below resonance results in one winding receiving more voltage than its twin. It is apparent, for instance, that if fr remains constant and f+ increases, the result will be an increase in E.L1.

Figure 4A shows a series circuit of L, R and C.

Figure 4B shows a parallel circuit of L and C, and the way external impedance across the L/C combination varies off-resonance. Changing from maximum at resonance, it decreases in value if the circuit is tuned either below or above center.

Judging from the increasing complications of modern receiver circuits, and with television on the way to outrank all other headaches we have known to date, it is probable that the vector diagram will assume an ever increasing importance as a valuable aid in explaining or illustrating circuit phenomena.

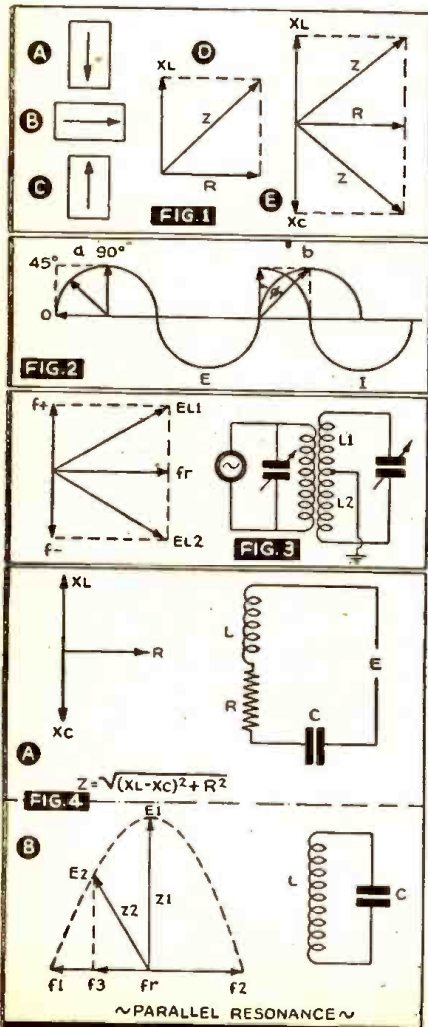

# SAVE MONEY WITH THIS Free Book



RADIO  
PARTS  
P.A. EQPT.  
HAM EQPT.

What a book to have! Just open it to the section you are interested in—there's your radio, sound system, your choice of nationally advertised parts. Everything in radio is here. But that's only the start of the story! Lafayette prices are the lowest—saving you money on everything you buy. Send for your FREE copy of this great buying guide today. Just tear out and mail the coupon.

## Lafayette Radio

100 SIXTH AVENUE, NEW YORK, N. Y.  
CHICAGO • ATLANTA • BOSTON  
NEWARK • BRONX, N. Y. • JAMAICA, L. I.

LAFAYETTE RADIO CORP.  
DEPT. 381—100 SIXTH AVE., NEW YORK, N. Y.  
Rush FREE Catalog No. 82

NAME \_\_\_\_\_  
ADDRESS \_\_\_\_\_  
CITY \_\_\_\_\_ STATE \_\_\_\_\_



## FLIGHT THE PICTORIAL FLYING REVIEW

Brings you all the phases of world aviation and aeronautics in a non-technical yet educational manner—excellent articles which catch your breath, yet give you the fundamentals of flying and all related subjects. FLIGHT keeps you abreast of all the major developments as fast as they appear anywhere. Now, when a plane and flying are of vital importance to all, you just can't do without this highly absorbing yet instructive publication. You must be "in the know." Attractive three-color cover, numerous illustrations. **15c** per copy

Partial Contents of the February issue: Inside a Bomber on the Attack, Aerial Troop Trailers, Air Battle "Sky Writing," Dive, Altitude and Attack Bombing, Anti-Aircraft Defense, Searchlights—the Curse of the Night Bomber, How R.A.F. Fighting Planes Attack German Bombers, England's Air Raid Precautions, How German Bombers Dive Through Smoke Rings, Barrage Balloons.

Subscription price \$1.50 a year, Canada and foreign \$2.00.

## SAVE UP TO 50% 30 DAYS TRIAL 15-TUBE MIDWEST RADIO

**FACTORY-TO-YOU**

PUT THIS CHASSIS IN YOUR PRESENT CABINET

LIBERAL TRADE-IN ALLOWANCE on many new models shown in FREE catalog—from 6 to 18 tubes—up to 5 bands—including automatic recording radio phones... Home Recorder, etc. (User-Settable Wanted)

**ONLY \$19.95**

COMPLETE CHASSIS WITH TUBES AND SPEAKER

FOREIGN RECEPTION DIRECT

UP TO **\$25.00** TRADE-IN ALLOWANCE

**EASY TERMS**

MIDWEST RADIO CORPORATION  
DEPT. 12-FF CINCINNATI, OHIO

# A New A.F.-Drift Correcting, Signal-Balancing, Direct-Coupled F.M. 24-WATT AUDIO AMPLIFIER



This wide-range amplifier, which was partially described in a preceding issue, incorporates a new A.C.-D.C. balancing circuit. It is the perfect auxiliary for use with Frequency Modulation tuners, as it passes 13 to 30,000 ( $\pm 1$  db.) cycles, and has a noise level of 75 db. below rated output. Distortion is only 1% total harmonics at average working level! Push-pull balanced negative-feedback is incorporated.

A. C. SHANEY

PART III

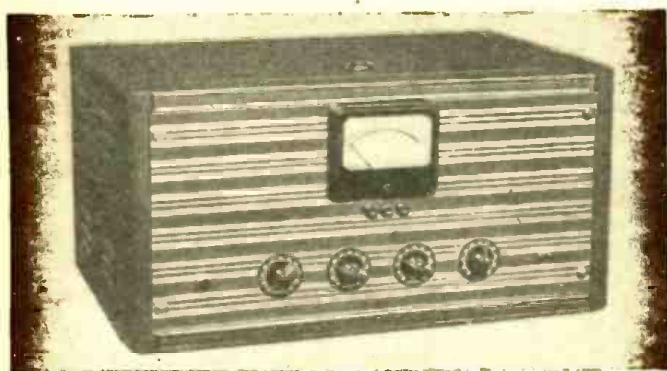

Appearance of the completed F. M. Amplifier. This novel amplifier, designed at the suggestion of R. D. Washburne, employs a basically new dynamically and statically balanced direct-coupled output stage, as well as an equalized self-balancing inverter, and D.C. supply for preamplifier and inverter tubes. All necessary precautions have been taken in its design and construction to avoid obsolescence.

rectly from the plates of the output tubes, it is apparent that compensation for discrimination within the output transformer would not be effected. During the development of this unit, a tertiary feedback winding was checked, and it was found that a distinct phase shift occurred between the primary of the transformer and the tertiary winding. This latter winding was not always in-phase with either the secondary or the primary. Such a condition naturally results in feedback regeneration at some frequencies. This confirmed a long-standing theory that tertiary windings are not ideal for feedback purposes.

By slight adjustments of feedback resistors, they may be coupled directly to any one of the output taps, so that any variations in the coefficient of coupling between the used output terminals and the 500-ohm line (if these terminals are not used), will not have any effect upon the desirable action of the feedback loop.

### THE EQUALIZED SELF-BALANCING INVERTER

One of the major problems in developing an ideal inverter is to be able to obtain equal voltages (out-of-phase) from each side of the inverter output. Reasonable variations in tubes should not produce objectionable unbalance. A basic circuit for a popular self-balancing inverter is given in Fig. 6. In this circuit, balancing action is obtained by including a common grid-return resistor ( $rg2$ ) in the push-pull stage following the inverter. Balancing action for variation in the amplification factors of  $V1$  and  $V2$  is obtained by applying the differential voltage which appears across  $rg2$  back to the grid of  $V2$ . While this action is very effective, it does not provide a perfect balance when  $V1$  and  $V2$  are reasonably matched. In fact, normal operation of this circuit provides an unbalanced signal at

**A** NUMBER of questions have been repeatedly asked of the writer since the initial article describing this F.M. amplifier appeared. Among these were: "Why is it necessary to extend the range of the amplifier from 13 to 30,000 cycles?" "Why is a 24-watt amplifier required for reproduction of phono or F.M. programs in an average home?" Both of these questions are answered in this article, after the technical description has been completed.

### THE BALANCED FEEDBACK CIRCUIT

The voltage which appears in the balanced 500-ohm winding of the output transformer is fed back to the cathode circuit of the 6SJ7 drivers through a bridged circuit. This particular feedback circuit can best be studied by redrawing the original circuit, which appeared on Page 352 of the Dec., 1940 issue, as shown in Fig. 1, below. An analysis of this bridge circuit will show that, under normal conditions, no voltage will appear from cathode to cathode of the input tubes. The A.C. voltage across

$rk2$  will be equal to 0. If the feedback resistors  $rb$ ,  $rb1$ , or the cathode resistors  $rk$ ,  $rk1$ , or the feedback windings, are unbalanced, a voltage will be present across  $rk2$ . As the input tubes are operating in push-pull, the voltage which appears across  $rk2$  must be in-phase with one of the cathodes, and out-of-phase with the other. It therefore degenerates with the cathode circuit with which it is in-phase, and regenerates with the circuit with which it is out-of-phase. This action, in turn, tends to further balance the voltage across the plates of the driver tubes. Its overall effect greatly increases the overall dynamic stability of the amplifier.

The advantages of running the feedback loop from the secondary of the output transformer back to the cathodes of the input tubes are as follows:

- (1) By embracing the output transformer, the feedback loop corrects for frequency discrimination.
- (2) Most effective circuit stability is attained by coupling the balanced output feedback circuit directly to the push-pull drivers.

If the feedback voltages were taken di-

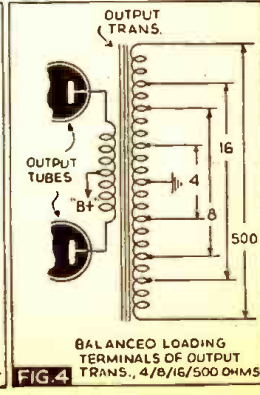
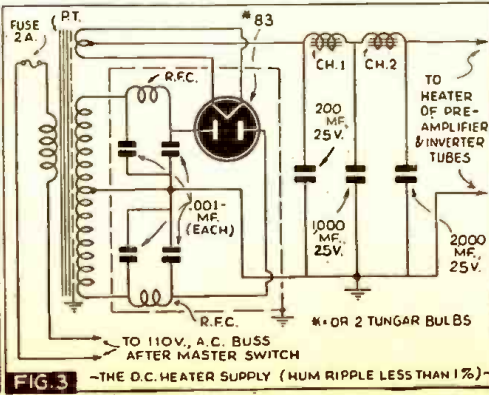
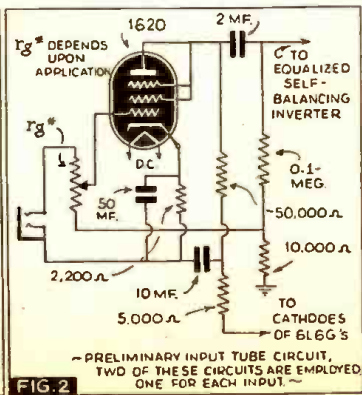
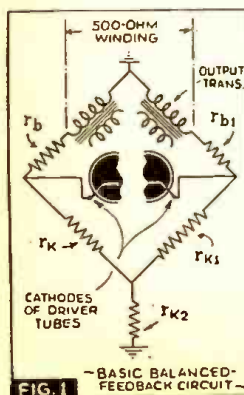

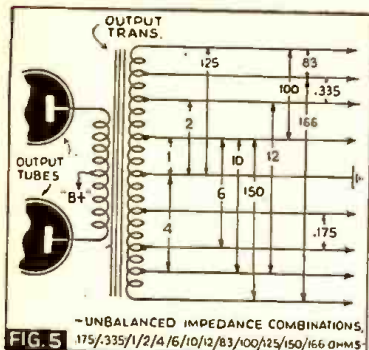

FIG. 5 UNBALANCED IMPEDANCE COMBINATIONS, 175/.335/1/2/4/6/10/12/83/100/125/150/166 OHMS

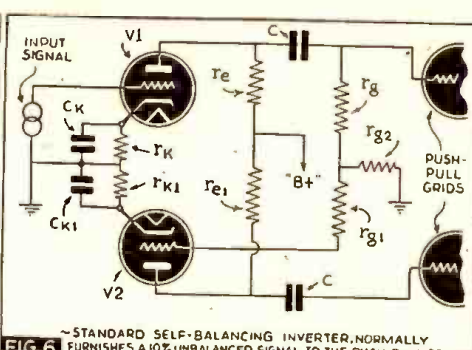

FIG. 6 STANDARD SELF-BALANCING INVERTER, NORMALLY FURNISHES A 10% UNBALANCED SIGNAL TO THE PUSH-PULL GRIDS

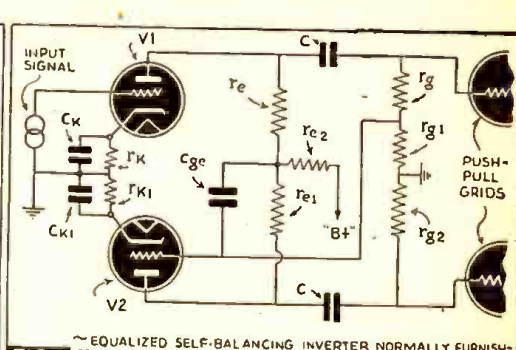

FIG. 7 EQUALIZED SELF-BALANCING INVERTER NORMALLY FURNISHES A PERFECTLY BALANCED SIGNAL TO THE PUSH-PULL GRIDS

the grids of the output tubes. While this unbalance may not be serious, it nevertheless, introduces distortion. To correct this condition, the equalized self-balancing circuit, illustrated in Fig. 7, was developed. In this circuit, a common plate load resistor is inserted in series with both plate loads of V1 and V2. Any unbalance in output voltage appears across r2 and is coupled through condenser cg to the grid of V2. If this unbalance is opposite in phase to the signal being impressed upon the grid of V2 through the dividing network rg and rg1, then degeneration takes place so as to decrease the output of V2, which in turn, equalizes the signals appearing on the grids of the output stage. On the other hand, if the residual voltage appearing across r2, is in-phase with the voltage being impressed to the grid of V2 through the dividing network rg and rg1, then, regenerative coupling takes place, to increase the output of V2. The great advantage of this equalized self-balancing inverter over the standard self-balancing inverter is that 100% balance is normally attained.

In order to ascertain the relative effectiveness of both circuits, the amplification factor of V2 was altered. In one case the output voltage of V2 was normally adjusted to produce twice that of V1, and in the other case, it was adjusted to produce one-half of V1. Both of these adjustments were made without either balancer in the circuit. Then both balancers were incorporated, and the following data tabulated: (In order to evaluate the effectiveness of the balancing actions, the percentage of unbalance is given under various conditions).

| Condition          | Percentage of Unbalance at P.P. grids |                                   |
|--------------------|---------------------------------------|-----------------------------------|
|                    | Self-balancing Inverter               | Equalized Self-balancing Inverter |
| Balanced Tubes     | 10%                                   | Perfect balance                   |
| V2 Unbalanced +50% | 20%                                   | 22.5%                             |
| V2 Unbalanced -50% | 9%                                    | 11%                               |

It should be noted that while the standard self-balancing inverter provides a slightly better (by 2.5%) balancing action under widely unbalanced tube conditions, the equalized self-balancing inverter provides for better balancing under normal operating conditions. It should be remembered, that the data indicated, was obtained by unbalancing V2 50% in either direction. This represents a far greater change than ever encountered in actual experience.

**SELECTION OF THE INPUT TUBES**

As the input tubes and their associated circuits determine the residual noise level within the amplifier, it was decided to carefully check all prevailing tubes and standard circuits in an effort to attain a condition which would provide the highest gain-to-noise ratio.

In conducting these tests, a wide variety of tubes were set up in standardized circuits. Both the gain and their noise were measured under a wide range of operating conditions, so as to obtain the optimum gain-to-noise ratio. One of the preliminary acceptable circuits is given in Fig. 2. It will be noted that the type 1620 triple-grid amplifier tubes are used. It is not to be construed, however, that these are the only desirable tubes. As a matter of fact, a number of other types may be used, depending upon the ultimate application of the amplifier.

In checking residual noise, it was found that in many tubes, hum constituted a substantial portion of noise. By substituting a storage battery supply, many "hummy" tubes had their overall noise reduced from 8 1/2 to 10 db. It was therefore decided that a D.C. supply would be incorporated within the amplifier to heat the preamplifier and inverter tubes.

**THE D.C. HEATER SUPPLY**

By connecting the 1620s in parallel, and then in series with the 6N7s, a 12-volt 600 ma. supply was required. Work done in our laboratory about 2 years ago, utilizing a type 83 to deliver 1A. at 24 V. proved the advisability of building an "A" supply around this tube. Our lab records had shown 1,000 hours' test without any measurable decrease in emission. The "A" supply rectifier system was therefore built around this type of tube circuit, which is illustrated in Fig. 3.

The writer feels that many readers will think that the 83 would be considerably over-worked in this circuit, in view of the fact that its published D.C. output current rating is 225 ma., maximum. Its peak plate current, however, it will be noted, is 675 milliamperes, maximum. This rating, though, is applicable to a 450-volt condition. It appears from empirical data, that when lower voltages are applied to the plates of the 83, such as 30 or 35 volts, a much higher current can be drawn, and still obtain reasonable life from the tube. A number of photocell exciter lamp supplies, incorporating four 83s and delivering 10 volts at 4 amperes, have proven the dependability of this type of circuit. For sceptical readers however, the amplifier can easily be redesigned to accommodate standard tungar bulbs in place of the 83 rectifier.

It will be noted that a pair of R.F. chokes and bypass condensers are employed in the filter circuit to avoid any disturbances from interfering with A.M. tuners, should they be used with this amplifier.

**PLATE AND BIAS SUPPLIES**

A study of the original power supply circuit will indicate that 2 rectifiers are employed in a tandem power supply circuit. A 5U4G supplies plate voltage to the drivers, preamplifiers, and inverter tubes, while a 5V4G supplies plate voltage to the power

output stage. As a 5V4G is a slow-heating rectifier, plate voltage cannot be applied before the full bias appears at the control-grid of the output stage.

Thus by carefully designing the power transformer and its associated filter this circuit affords increased life of power output tubes as compared to circuits employing 2 rapid-heating or 2 slow-heating bias and plate supply rectifiers.

**THE BALANCED OUTPUT CIRCUIT**

Although the original circuit showed a balanced output transformer equipped with 4/8/500-ohm taps, this transformer can be supplied with any variation of impedances. It has been standardized, however, with 4/8/16/500-ohm windings. The balanced nature of the transformer provides a wide variety of impedances, which are obtained either by balanced or unbalanced loading. A balanced loading circuit is illustrated in Fig. 4. Figure 5 shows the unbalanced output terminals available, ranging from 0.175-ohm to 166 ohms. It will be noted that a total of 16 impedance combinations are available, ranging from 0.175-ohm to 500 ohms.

Although the transformer may be loaded in an unbalanced fashion, true balanced feedback and push-pull action throughout the driver and power output stage still takes place. An analysis of the unbalanced loading circuit diagram, will clarify this point. Regardless of where the load is applied, the voltage from either terminal of the 500-ohm line to ground, would be identical. If any variation does exist, it would be caused by a difference in the coefficient of coupling from the loading portion of the secondary to the 500-ohm terminal on the same side. It is a relatively simple matter, however, to over-design the output transformer so as to provide a unity coefficient factor under any conditions of normal unbalanced loading.

**POWER OUTPUT RATING OF THE AMPLIFIER**

In rating the power output of an amplifier used for F.M. applications, the reader should dis-associate himself from conventional P.A. amplifier ratings, as unfair evaluation will take place, if this factor is not taken into consideration.

Ordinarily, a P.A. amplifier can safely be rated up to 5% or 7%. In most P.A. applications, this amount of distortion would not be readily detected. In F.M. work, however, it is imperative that the amplifier be operated at not more than a total of 1% distortion. This precaution must be taken, as originally outlined, to prevent the amplifier from becoming the bottle-neck of distortion in the entire F.M. transmission-reception chain.

Although the amplifier delivers a maximum output of 30 watts, it has been rated at 24 watts for 1% total harmonics. It is intended, however, to be normally operated at an output level of 12 watts which pro-

vides less than 1/2 of 1% total distortion. These unusually low ratings are advocated so as to virtually eliminate distortion considerations from the amplifier. It should be borne in mind, however, that if the unit is operated at an average level of 3 watts to produce unmeasurable harmonics, transient increases of level of 9 db. will bring the power output up to 24 watts with its intended 1% of total harmonics. Many so-called de-luxe F.M. radio receivers employ relatively low power output stages to effect appreciable economies, particularly when large quantities of receivers are involved.

**WIDE-RANGE RESPONSE**

*The development of an amplifier having a response of from 18 to 30,000 cycles ± 1 db., obviously increases its overall cost, and sometimes raises the question, "Why should I buy an amplifier with such a wide-range response, when F.M. broadcasts only run from 50 to 15,000 cycles? Furthermore, the average human being can not hear 30,000 cycles."*

To answer this question intelligently, we must first acknowledge the fact that the latest findings amongst young listeners with acute hearing clearly indicate that 30,000 cycles CAN be perceived! Furthermore, fundamentals and sub-fundamentals, should be reproduced, in order to avoid destruction of original tone qualities. This can easily be proven by a difference in quality of response of bass drums or organ programs when fundamentals are cut off. In view of the fact that the response range of amplifiers has been continually increasing the writer believes that it is only a question of time before the ultimate amplifier will extend out to the outermost limits of

human hearing, and, if this can be accomplished now, why shouldn't the amplifier be removed as a restricting link in the chain of reproduction?

We note that in the past, loudspeaker manufacturers have consoled themselves for restricted response by contending that no "program or amplifier can reproduce more than 5,000 cycles." Record manufacturers complained that no phono pickup could reproduce more than 6,000 cycles, and pickup manufacturers contended that no amplifier passed more than 8,000 cycles. This vicious circle naturally hindered projected improvements in any one branch.

These illogical assumptions really have no place in modern communication equipment. If F.M. stations are forced by the F.C.C. to provide 50 to 15,000 cycles, the writer believes it is only a question of time before this spectrum will be balanced\* and some of the better stations will eventually extend this range to the very outer limits of human hearing.

In providing this extremely wide range within the present amplifier, any possibility of early obsolescence is completely eliminated, for further extension of the range is obviously unnecessary, unless the human race during the process of evolution will acquire an extended hearing range.

**CONCLUSION**

The writer wishes to caution readers not to compare this amplifier with conventional public address units, by checking power output, distortion, hum, or tube components, as a number of essential features have been included in its design, which are highly

\* See "Balanced Audio Spectrums," Radio-Craft, September, 1940, Page 164.

desirable, in order to attain the full benefits from F.M. broadcasting.

Because of its technical excellence, it can of course, be used in any other application requiring the ultimate in design and performance.

Due to numerous requests by *Radio-Craft* readers, many of whom either telephoned or called in person, we present the following additional information on the currents and voltages at the outputs of the high-voltage and bias supplies of the F.M. Audio Amplifier described here and in the preceding December and January issues. Refer to the diagram of the complete basic amplifier in the December issue, pg. 352. The normal D.C. out of the 5V4G's filter system (high-voltage supply) is 160 ma. at 590 V. (to ground). Normal D.C. out of the 5U4G's filter system (bias supply) is 22 ma. at 185 V. (to ground).

**NEWS SHORTS**

Add new radio slang: "lavalier" microphone, WOR's terminology for the around-the-neck mikes that sports broadcasters use at games, races, etc. Here's another: "cough button", another bit of coinage by ever-ingenuous WOR-men, and referring to the off-on pushbutton now available in the studios to permit cutting off the mike during spasmodic expulsions of breath.

If a stock troupe plays in your city Al Jolson's "Hold on to Your Hats", currently showing in New York City, you may see the same 4 scenes in a radio station as are now being used. They're a close copy of set-ups at WMCA.

**Mr. Radio Serviceman:**

**RSA MEANS BUSINESS!**

New business promotion plans and new member-helps spell increased profits for RSA members at the start of the new season. Watch for the RSA Replacement Parts Guide—New Broadcast Promotions—New Member Helps! Don't be the last man in your neighborhood to join RSA. Send the coupon Today!

**MAIL THIS COUPON NOW!**

RADIO SERVICEMEN OF AMERICA, INC.  
304 S. Dearborn St., Chicago, Ill.

I am interested in RSA Membership. Tell me about it.

Name .....

Address .....

City ..... State .....

RC-2-41

**Let's Grow Together  
in 1941!**



**RADIO SERVICEMEN  
OF AMERICA, Inc.**

**Reliable Service Assured**

**JOE MARTY, JR., EXECUTIVE SECRETARY  
304 S. DEARBORN STREET, CHICAGO, U.S.A.**

*Circuit Features of the Latest*

# ULTRA-H.F. "DX" F.M.-A.M. RECEIVER

*Here described is a receiver, recently placed on the market, of wide technical interest to many because of its unusual variety of unique features, outstanding among which are an ultra-highfrequency tuning range extending from 27 to 145 megacycles, and the ability to tune-in both F.M. and A.M. signals. A panel meter, affords "S" indications on A.M. signals, and exact carrier-center adjustments on F.M. programs.*

S. GORDON TAYLOR

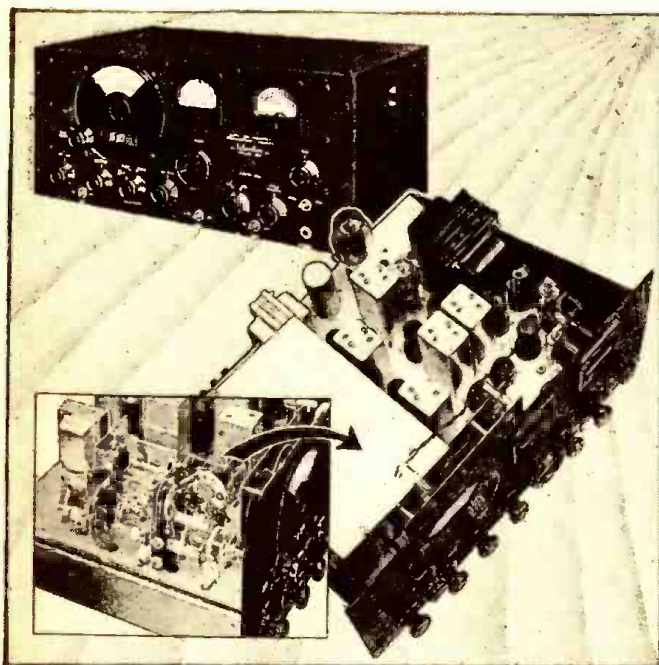

The Hallicrafters S-27 meets the requirements of all services—broadcast, ham, experimental and commercial.

Careful R.F. alignment is important but somewhat less critical at these ultra-high frequencies than in lower-frequency circuits. There is one marked difference encountered here, however, in that it is impractical to attempt fixed alignment of the antenna circuit because of the influence of the antenna by reflection. For this reason the antenna trimmer control is brought out to the front panel and constitutes an incidental tuning control.

Oscillator coupling represents one of the most difficult problems in u.-h.f. receiver design. All conventional coupling systems seem to result in limiting the oscillator tuning range, inadequate input to the mixer, or non-uniform conversion gain and even complete failure of the oscillator in certain portions of the desired range. The method employed in the S-27, which is believed to represent an exclusive development, overcomes these troubles beautifully. This method consists of closely coupling a pick-up coil to the oscillator grid coil and feeding its output through a small condenser to the cathode of the mixer. The pick-up coils vary in size from 1/2 to 2 turns and result in an impressed voltage of from 1 to 3 volts between the mixer cathode and ground.

**T**HE radio set here illustrated combines, for instance, the sensitivity and selectivity required by the ham in his u.-h.f. "DX" pursuits, with the broad-band, high-fidelity requirements for F.M. broadcast reception; the sturdiness and flexibility of operation called for in commercial services, with the wide tuning range needed by the experimenter whose desire it is to cover all types of services throughout the u.-h.f. ranges now in use or proposed for the near future. And in this combination it contributes the best features of each to others.

### R.F. FEATURES

In general design this S-27 is a communications-type receiver designed for exceptional flexibility in operation. In all it employs 15 tubes in the circuit shown in Fig. 1.

In switching from A.M. to F.M. reception it substitutes limiter and discriminator stages for the A.M. detector, and an extra (sharply tuned) I.F. stage, with the result that for either type of reception a total of 13 tubes is employed.

The R.F. end will be recognized at once as unique in the field of wide-range u.-h.f. design in that (a) it includes a tuned pre-selector stage on all ranges, (b) utilizes "acorn" tubes in all u.-h.f. circuits, and (c) incorporates a new oscillator-coupling method. The overall result is a most unusual combination of sensitivity and low noise level. Actual measurements show the average gain, from antenna input terminals to the grid of the mixer, to be 96 for the 27-47 mc. range, 30 for the 46-82 mc. range, and 9 for

the 81-145 mc. range; equally impressive the maintenance of average conversion gain of 8, so uniform throughout the entire tuning range that its minimum is 7.4 and its maximum 9.7.

The selection and layout of circuit components contribute to this efficiency. Band-switching is employed, but in spite of this, all important leads (and every lead is important at these frequencies!) are kept extremely short. This is accomplished by mounting all coils directly on the switch, the tubes with their plate and grid terminals right at the related circuits, and the 3-gang tuning condenser so close to the switch assembly that the interconnecting leads are only about 1/4-in. long. Bypass condenser leads are held to a length of approx. 1/8-in.

One of the accompanying photos shows this R.F. section with its shield-cover removed. Not only is this section completely isolated from the balance of the receiver by its separate sub-chassis and shield cover, but the antenna, R.F. and mixer circuits are in turn isolated from one another by shield partitions. The R.F. and mixer tubes are mounted through individual partitions and in this way the shielding between their input and output terminals so vital to maximum stable gain is obtained.

To maintain uniform voltage on these tubes a VR-150 voltage regulator tube is employed. Plate voltages of only 150 are used, to insure long life for the "acorn" tubes, some of which prove relatively short-lived when operated at their rated value of 250 volts.

### I.F. FEATURES

The intermediate amplifier is tuned to 5.25 mc. This relatively high frequency avoids the narrow frequency-pass characteristics of low-frequency I.F. stages and, with expansion, provides the band-width necessary to accommodate the wide swing of F.M. signals. The actual band width in the expanded position (F.M.) at the grid of the limiter is 218 kc. at 2X down. For A.M. reception an additional sharply-tuned I.F. stage is cut in, providing selectivity of 13 kc. at 2X down; 36 kc. at 10X down; 80 kc. at 100X down; and 123 kc. at 1,000X down. This is with the selectivity control in the SHARP position. In the BROAD position these values becomes 58, 130, 254 and 348 respectively.

Two expanding-type I.F. stages are in the circuit at all times. With the F.M.-A.M. switch in the F.M. position the limiter stage provides additional I.F. gain for extremely weak signals, but full limiter action on all inputs above 5 microvolts. The tube used here is an 1852 in order to provide high output in spite of the relatively low primary load imposed by the coupling transformer.

The curve of Fig. 2 shows the almost perfect linearity of discriminator action over a range considerably exceeding the carrier-swing utilized in present F.M. broadcast transmitters. The careful design of the coupling factor in the discriminator transformer accounts for the wide range, while linearity is obtained through critical selection of the load resistor value across the primary of this transformer.

In the A.M. position the input to the radio system is switched to the channel which



F.M. "DX"

The special emphasis placed on R.F. sensitivity in the design of this set may be considered superfluous by some. But it must be remembered that for some time to come F.M. broadcasting will be largely limited to the vicinity of metropolitan centers. Those who live beyond the limits of the relatively limited metropolitan area coverage will in many cases need receivers of unusual sensitivity if they are to be able to enjoy the advantages of this type of broadcasting. The incorporation of high R.F. gain serves the dual purpose of improving both sensitivity and the signal-to-noise ratio and will therefore provide for the more remote listener enjoyable reception of F.M. broadcasting which would otherwise not be available to him. This is not to say, of course, that even a receiver such as the one under discussion here will enable everyone to have this advantage, but it will hold true for many who live 10, 20 or perhaps 30 miles beyond normal areas of coverage.

Additional notes: The I.F. is 5.25 mc.; in the diagram the shorting plug (shown at lower-left) must be in socket "P" for A.C. operation.

VALUES OF CIRCUIT COMPONENTS

| RESISTORS |           | WATTS                |                    |
|-----------|-----------|----------------------|--------------------|
| NO.       | OHMS      |                      |                    |
| 1         | 250       | 1/3                  |                    |
| 2         | 1,000     | 1/3                  |                    |
| 3         | 1,000     | 1/3                  |                    |
| 4         | 10,000    | 1/3                  |                    |
| 5         | 2,000     | 1/3                  |                    |
| 6         | 1,000     | 1/3                  |                    |
| 7         | 100,000   | 1/3                  |                    |
| 8         | 1,000     | 1/3                  |                    |
| 9         | 8         | 1/3                  |                    |
| 10        | 100,000   | 1/3                  |                    |
| 11        | 10,000    | 1/3                  | R. F. Gain Control |
| 12        | 35        | 1/3                  |                    |
| 13        | 120       | 1/3                  |                    |
| 14        | 40,000    | 1/3                  |                    |
| 15        | 300       | 1/3                  |                    |
| 16        | 8         | 1/3                  |                    |
| 17        | 100,000   | 1/3                  |                    |
| 18        | 100,000   | 1/3                  |                    |
| 19        | 100,000   | 1/3                  |                    |
| 20        | 200       | 1/3                  |                    |
| 21        | 1,000     | 1/3                  |                    |
| 22        | 3,000     | 1/3                  |                    |
| 23        | 8         | 1/3                  |                    |
| 24        | 500,000   | 1/3                  |                    |
| 25        | 300       | 1/3                  |                    |
| 26        | 5,000     | 1/3                  |                    |
| 27        | 1,000     | 1/3                  |                    |
| 28        | 7,500     | 1/3                  | 10 Wire Wound      |
| 29        | 2,000     | 1/3                  |                    |
| 30        | 20,000    | 1/2                  |                    |
| 31        | 50,000    | 1/3                  |                    |
| 32        | 1,000,000 | 1/3                  |                    |
| 33        | 100,000   | 1/3                  |                    |
| 34        | 250,000   | 1/3                  |                    |
| 35        | 500,000   | 1/3                  |                    |
| 36        | 250,000   | 1/3                  |                    |
| 37        | 15,000    | 1/3                  |                    |
| 38        | 50,000    | 1/3                  |                    |
| 39        | 250,000   | 1/3                  |                    |
| 40        | 100,000   | 1/3                  |                    |
| 41        | 100,000   | 1/3                  |                    |
| 42        | 200,000   | 1/3                  |                    |
| 43        | 500,000   | 1/3                  | Audio Gain Control |
| 44        | 250,000   | 1/3                  |                    |
| 45        | 250,000   | 1/3                  |                    |
| 46        | 5,000     | 1/3                  |                    |
| 47        | 5,000     | 1/3                  |                    |
| 48        | 120       | 1/3                  |                    |
| 49        | 250,000   | 1/3                  |                    |
| 50        | 250,000   | 1/3                  |                    |
| 51        | 100,000   | 1/3                  |                    |
| 52        | 250       | 1/2                  |                    |
| 53        | 10,000    | 1/3                  |                    |
| 54        | 4,000     | 1/2                  |                    |
| 55        | 5,000     | 1/2                  |                    |
| 56        | 600,000   | 1/3                  |                    |
| 57        | 35        | 1/3 Wire Wound       |                    |
| 58        | 1,500     | 5. meter Zero Adjust |                    |
| 59        | 3,200     | 10 Wire Wound        |                    |
| 60        | 25,000    | 1/2                  |                    |
| 61        | 50,000    | 1/3                  |                    |
| 62        | 300       | 1/3                  |                    |
| 63        | 5,000     | 1/3                  |                    |
| 64        | 20,000    | 1/3                  |                    |
| 65        | 35        | 1/3                  |                    |

| CONDENSERS |          |              |              |
|------------|----------|--------------|--------------|
| NO.        | CAPACITY | NOTES        | TYPE         |
| 1          | 60 mmf   | Per Section  |              |
| 2          | 15 mmf   | Ant. Trimmer | Air          |
| 3          | 5 mmf    |              | 3 Ceramicons |
| 4          | .002 mfd |              | Mica         |
| 5          | 300 mmf  |              | Mica         |

# "HAVING A SWELL TIME," WRITES ABNER BUGLE, "WISH YOU WERE HERE"

Abner Bugle is the man who used to write the advertisements for Sprague Condensers.



Nobody could juggle adjectives more gracefully than Abner and, when it came to slapping on the superlatives, even Abner admitted he was just about tops in his profession. But Abner ran into a snag one day, and here is how it happened:

"Look, boss," he wailed to the president of the advertising agency for which he worked. "I'm in a helluva fix. There's nothing more to say about Sprague Atom midjet dry electrolytic condensers."

"What!" roared the president, gnashing his teeth so hard he bit the stem off his Meerschaum. "Don't be a fool, Bugle! Why, Atoms build up quicker. They stand higher surges. Their low leakage avoids overheating. They're smaller, and they've got more guts than—" "I know all that," mourned Abner. "But every cheap condenser makes just about the same claims—whether they can live up to 'em or not. They may not be as good as Atoms in a radio set, but they look just as good in an ad. I don't know what to do."

"Jeepers Creepers, man!" the president's bellow shook the oil painting of the 50th million Sprague TC Tubular hanging on the wall. "And you say you're an advertising expert! Of course Atoms are better. They're unconditionally guaranteed."

There isn't a firecracker in a carload—not in a trainload—two trainloads—three trainloads—

"I know that, boss," wailed Abner. "But you can't PROVE those things in print. No matter if he fills 'em with mush and wraps 'em in tissue paper, another manufacturer might CLAIM that his condensers are as good as Atoms."

The president did not reply. Grasping pad and pencil, he suddenly began to write. For two hours, Abner stood by, pale and wan and there was no other sound save the feverish scraping of the boss' gold pencil.

"Eureka!" shouted the president finally. "I've got it. Here's what we'll say in our next ad. Listen to this:

"We're glad most condensers are bought on the basis of hard-boiled engineering tests rather than mere advertising claims. When quality is allowed to speak for itself, there can be no mistaking what it says. That's why Spragues are today specified by leading users throughout the world."

"Splendid copy, boss—and it's all true," said Abner, breathing a deep sigh of relief.

"Splendid nothing!" snorted the president. "It's perfect. What's more, you're fired, Bugle. In the future, I'll write the Sprague ads myself."

**SPRAGUE PRODUCTS COMPANY**  
North Adams, Mass.

P.S.—When last heard from, Abner Bugle had become a beachcomber in Tahiti. "Having a swell time—wish you were here," is what he wrote on a post card and added: "It's a great life. Beats advertising to a frazzle."

| NO. | CAPACITY | VOLTAGE | TYPE         |
|-----|----------|---------|--------------|
| 6   | .002 mfd |         | Mica         |
| 7   | 10. mmf  |         | Ceramicon    |
| 8   | 10. mmf  |         | Ceramicon    |
| 9   | 300 mmf  |         | Mica         |
| 10  | 300 mmf  |         | Mica         |
| 11  | .01 mfd  | 600     | Paper        |
| 12  | .001 mfd |         | Mica         |
| 13  | .02 mfd  | 400     | Paper        |
| 14  | .02 mfd  | 400     | Paper        |
| 15  | .01 mfd  | 600     | Paper        |
| 16  | .001 mfd |         | Mica         |
| 17  | .02 mfd  | 400     | Paper        |
| 18  | .02 mfd  | 400     | Paper        |
| 19  | .01 mfd  | 600     | Paper        |
| 20  | 50 mmf   |         | Mica         |
| 21  | .02 mfd  | 400     | Paper        |
| 22  | .02 mfd  | 400     | Paper        |
| 23  | .01 mfd  | 600     | Paper        |
| 24  | 50 mmf   |         | Mica         |
| 25  | .05 mfd  | 400     | Paper        |
| 26  | 50 mmf   |         | Mica         |
| 27  | 100 mmf  |         | Mica         |
| 28  | 500 mmf  |         | Mica         |
| 29  | 25 mmf   |         | Mica         |
| 30  | .002 mfd |         | Mica         |
| 31  | 50 mmf   |         | Mica         |
| 32  | 500 mmf  |         | Mica         |
| 33  | .05 mfd  | 400     | Paper        |
| 34  | 30 mfd   | 25      | Electrolytic |
| 35  | 30 mfd   | 25      | Electrolytic |
| 36  | .05 mfd  | 400     | Paper        |
| 37  | .05 mfd  | 400     | Paper        |
| 38  | 20 mfd   |         | Electrolytic |
| 39  | .002 mfd |         | Mica         |
| 40  | .05 mfd  | 400     | Paper        |
| 41  | .05 mfd  | 400     | Paper        |
| 42  | 10. mfd  | 350     | Electrolytic |
| 43  | 30 mfd   | 350     | Electrolytic |
| 44  | 10 mfd   | 400     | Electrolytic |
| 45  | 300 mmf  |         | Mica         |
| 46  | 300 mmf  |         | Mica         |
| 47  | 300 mmf  |         | Mica         |
| 48  | .01 mfd  | 600     | Paper        |
| 49  | .01 mfd  | 600     | Paper        |
| 50  | .01 mfd  | 600     | Paper        |
| 51  | .01 mfd  | 600     | Paper        |
| 52  | .002 mfd |         | Mica         |
| 53  | 100 mmf  |         | Mica         |
| 54  | 200 mmf  |         | Ceramicon    |
| 55  | 300 mmf  |         | Mica         |
| 56  | 50 mmf   |         | Ceramicon    |
| 57  | .001 mfd |         | Mica         |
| 58  | 450 mmf  |         | Pad          |
| 59  | 2 mmf    |         | Twisted Pair |
| 60  | 25 mmf   |         | Control Air  |

**FREE** 300 Ways to Make Money

**Cash In!**

88 PAGES

BRAND NEW BOOK 40,000 WORDS in TEXT! In "CASH IN" you get ALL the real money-makers—dozens of profitable tested mail order plans, confidential business secrets, a zillion of practical tested formulas—successful tested schemes—actual experiences of men who have started on a shoestring—with less than \$10 capital.

**25 CENT**

**SOLD ON A MONEY-BACK GUARANTEE!**

**Buyers of This Book Tell Us—**

"Bestest value I've yet to see. Book is worth at least a dollar." S. Budin, H'klyn, N. Y.

"Your book is as good if not better than others selling at \$1.00." George Brunet, Montreal, Can.

"CASH IN" is the best value I have yet to see in the mail order field." Lawrence Fox, Brooklyn, N. Y.

"CASH IN" contains only tested ideas covering every type of full- or part-time enterprise—it's a "masterpiece" in business ventures.

**BOOK CONTAINS NO ADVERTISING GIVEN FREE TO YOU AS A SAMPLE TO INDUCE YOU TO SELL THIS BOOK AT A PROFIT**

Send 3c U. S. stamp to pay for mailing charges

**NATIONAL PLANS INSTITUTE**  
246-R Fifth Ave., N.Y.C.

**GOLDENTONE... 50% OFF**

DEAL DIRECT FACTORY PRICES — Over 60 models to choose from—4 to 12 tubes. Portables \$8.08 up. Farm sets \$8.98 up. Car sets \$8.98 up. Foreign band sets \$8.08 up. Samples 50% off. Quantity discounts. Free 1941 Bar. main catalog gives details of 10-day FREE trial, agent's proposition and discounts. Mail postcard.

**10 DAY TRIAL** **49¢ UP** **10 DAY TRIAL**

**Free Catalog** **RCA**

**YEAR GUARANTEE** **PLAY**

**GOLDENTONE RADIO CO., DEPT. RC, DEARBORN, MICH.**

# SOUND ENGINEERING

Free Design and Advisory Service  
For Radio-Craft Subscribers

Conducted by A. C. SHANEY

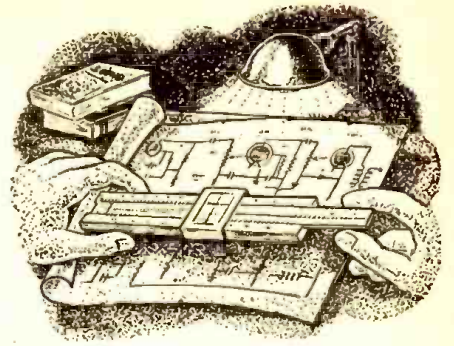

This department is being conducted for the benefit of RADIO-CRAFT subscribers. All design, engineering, or theoretical questions relative to P.A. installations, sound equipment, audio amplifier design, etc., will be answered in this section. (Note: when questions refer to circuit diagrams published in past issues of technical literature, the original, or a copy of the circuit should be supplied in order to facilitate reply.)

## No. 14

### SOUND-ON-FILM AMPLIFIER

#### The Question . . .

I have been a *Radio-Craft* subscriber for a number of years in Manila. Your department, Sound Engineering, is very interesting and I would like to submit a problem of my own.

I would like to construct an amplifier for "talkies" with 2 inputs, one each for phonograph and photocell with variable resistance (voltage divider), for the supply of 2 photocells, using the following tubes: 6F6 for voltage amplifier, 6N7 for driver or inverter, push-pull 6L6 for power, and 5Z3 rectifier.

Please favor me with a diagram, or you may publish it through *Radio-Craft*, using the above tubes; also show resistance and capacity values and voltages for high voltages. If possible, the amplifier should be capable of handling an undistorted power output of 30 watts.

ESTANISLAO S. FERNANDEZ,  
Tondo, Manila, Philippines.

#### The Answer . . .

A circuit diagram of the type you re-

quire, is illustrated in Fig. 1. You will note that individual photocell voltage adjustments are provided, so that the output level of both photocells may be matched. Both high-frequency and low-frequency attenuators are employed between the 2nd 6SF5 and the 6N7 inverter. This will enable you to adjust the response of the amplifier to suit local conditions.

With careful design, the amplifier will deliver approximately 24 watts at 2%. If more power is desired, it will be necessary to use either fixed bias or add another pair of push-pull 6L6Gs in parallel with the original output stage. If oscillation occurs under this latter condition, independent series-grid resistors or plate chokes should be used. This auxiliary circuit is indicated in Fig. 2.

The output transformer should have a 6,600-ohm plate-to-plate impedance. The use of a multi-tapped secondary is optional. The high-voltage secondary of the power transformer should be capable of delivering 250 milliamperes at 400 volts from each side of center-tap under full load conditions. If four 6L6s are used in the

power output stage, the output transformer should have an effective plate-to-plate impedance of 3,300 ohms. The power transformer should be capable of delivering approximately 350 ma.

### "HASH" AND HUM

#### The Question . . .

I have built and installed a 6-station intercommunication system connecting 6 places of business together. This system operates perfectly with one exception and that is interference from a neon sign that is on the front of one of the buildings, and to which it is necessary to go pretty close (20 ft.). Now I constructed this system to operate on low-impedance lines, talking direct from voice coil to line, and thought that I would not get much interference by so doing (and don't get any, except this high-tension buzz). Other neon signs do not seem to bother very much, although a little interference comes from others. This is not flasher interference, but high-voltage buzz. I have grounded the transformers on the sign, checked all insulators for leaks, etc., and have moved the lines at least 20 feet away, and still get the noise.

In moving them away, I incidentally placed them within 2 feet of another neon sign and got very little interference. So this offending sign is really putting out a hot signal. I have tried to get the sign company to

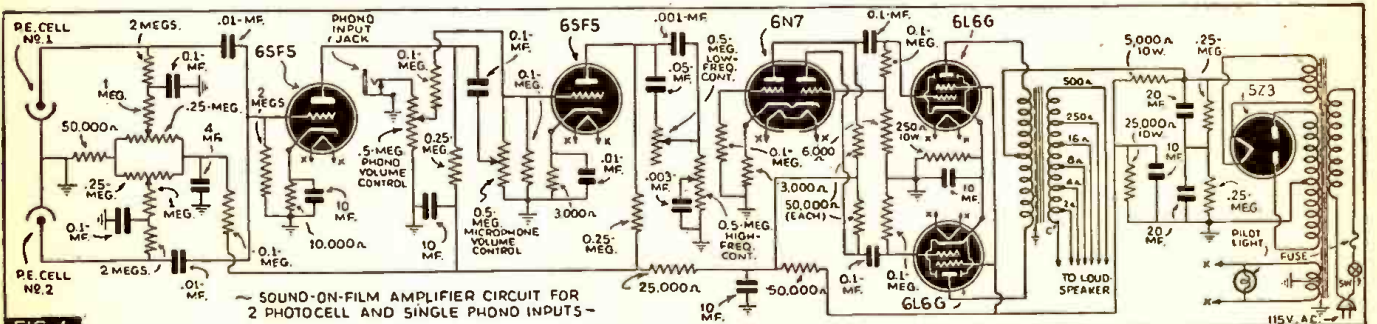

FIG. 1

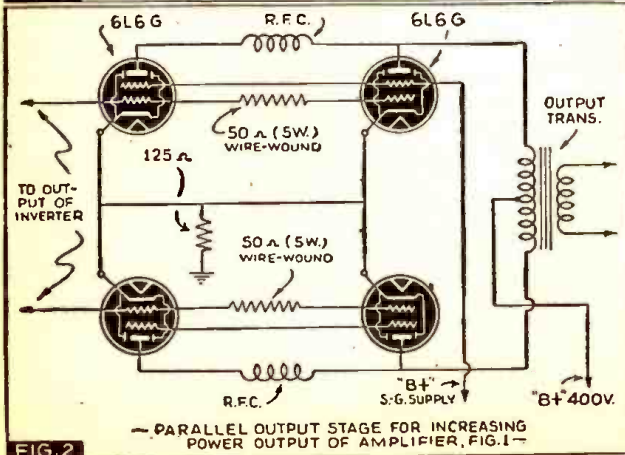

FIG. 2

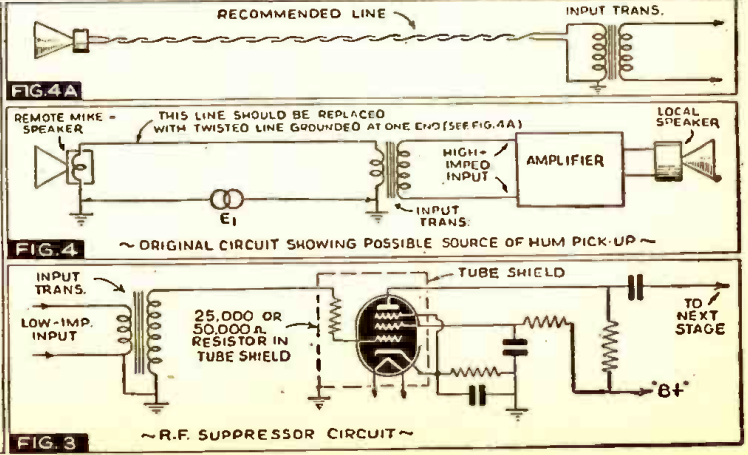

FIG. 3

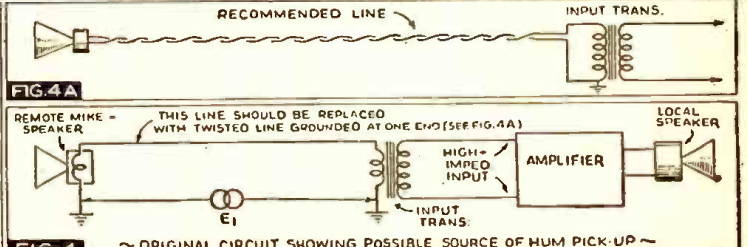

FIG. 4

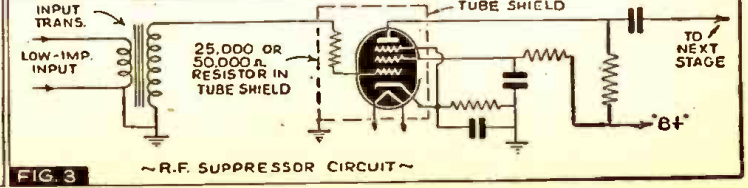

FIG. 4A



change the 2 transformers feeding this sign, but so far have not been successful. They say that no interference can come from the transformers as long as they are doing a good job of operating the sign. I know differently as I disconnected the secondaries on the sign from the tubing, and turned the sign on so that the transformers and about 3 feet of wire were all that was "hot," and I got nearly as much noise as I did when the sign was lit.

I would also like to state one more defect or rather undesirable thing about the system, and that is on one station only (the one with the longest run of wire), I get an excessive hum (same type noise as you get on open, unshielded grid inputs on P.A. work). Now due to the fact that these are voice coil lines, is it not possible to put some form of chokes or bleeders in the circuit?

I am sure you will agree with me in that it is unusual that such a long run on voice coil over such small wire works as well as it does. In fact, I don't see how it does work so well, but the quality and volume are OK. The reason for running the voice coils instead of using the high-impedance line from the transformers was to get away from cross-talk between lines that I was afraid I might have as I ran all lines in the same cable.

D. K. CHAPMAN,  
Florence, Alabama

*The Answer . . .*

The high-frequency disturbing buzz that you are experiencing may be injected into the amplifier circuit through the power line or through the voice coil lines. If the hash is introduced through the power lines, it will be necessary to insert a filter between the source of power and the neon transformer. An additional filter between the amplifier and the power line may also help. If the hash is introduced through the voice coil line, then an R.F. suppressor in the grid circuit of your input tube may help. An effective filter consists of a 25,000- or 50,000-ohm resistor connected from the grid of the tube to its input circuit. The resistor should be shielded within the tube shield. See Fig. 3.

From your preliminary tests it is obvious that excessive external leakage is taking place in the neon transformer, and I believe it might be simplest to have this transformer replaced.

The excessive hum that you are picking up on your long line is probably caused by using 2 different grounds. Your sketch (which is indicated in Fig. 4) shows that the 6-ohm voice coil is grounded remotely. This type of circuit may introduce a voltage E1 between the ground at the speaker and the ground at the input transformer. Any difference of potential between these 2 points will be fed into the primary of the input transformer through the speaker voice coil. This hum voltage may be stepped up through the input transformer and fed into the amplifier. One of the simplest ways of remedying this condition is to use a twisted wire from the voice coil of the remote speaker directly to the primary of the input transformer, as indicated in Fig 4A. With this arrangement, only a single ground connection at the input transformer will be required. If this long line should run parallel to high-amperage power circuits, it may inductively pick up hum. Under these conditions, it will be necessary to change the course of the line or to use a metallic shield.

The reason that the 1,000-ohm line does not seriously affect the performance of your system, is that your entire line, if you are using No. 18 wire, has a total resistance of approx. 6½ ohms. This introduces a voltage loss of about 50%.

# SOUND X/TRA TUBES

## FOR HEAVY DUTY AUDIO WORK

*Insure*  
**PEAK PERFORMANCE**

*In*

**AMPLIFIERS,  
PUBLIC ADDRESS  
SYSTEMS, SOUND  
PROJECTORS,  
INTER-OFFICE  
COMMUNICATING SYSTEMS,  
COIN OPERATED REPRODUCERS**



*Can Be Used to REPLACE*  
**ORDINARY TUBE OF SAME TYPE  
NUMBER FOR BETTER REPRODUCTION**

A very complete line of special heavy duty audio tubes. Just ask for National Union SOUND X/TRA and the type you want. Characteristics are the same as ordinary tubes and therefore no change whatever is required in the amplifier or installation. Just put the same type number of SOUND X/TRA TUBES in the tube sockets. You will notice the difference in lowered hum level and you will get improved performance and longer life without troublesome tube call-backs. The chief requirement for National Union's new SOUND X/TRA tube types is that they must be demonstrably better. In order to accomplish this outstanding performance in SOUND X/TRA types, modifications in construction and details of engineering were incorporated. Emission limits are very high to insure exceptional uniformity, long life and adequate power-handling capacity. Gas and grid current are held to exceptionally low limits to insure minimum distortion, uniformity and stability. Every tube is carefully tested for hum and microphonics and, where necessary, changes have been made in construction such as the use of special micas, extra rugged supports, double helix heaters and special insulation.

© 1940, N.U.R. CORP.

**DEMONSTRABLY BETTER**

- ★★★ NON-MICROPHONIC
- ★★★ LOW-HUM LEVEL
- ★★★ UNIFORM CHARACTERISTICS
- ★★★ NO MATCHING NECESSARY
- ★★★ LONG LIFE AT FULL OUTPUT

Ask Your N.U. Jobber or Write

# NATIONAL Union Radio Corp.

57 STATE ST., NEWARK, N. J.

FREE RADIO PARTS WITH YOUR SUBSCRIPTION TO RADIO-CRAFT. SEE PAGE 493.

## NEW AUDIOGRAPH Sound Catalog

AUDIOGRAPH Sound Systems represent the latest in Sound Engineering and Design—a complete line plus pre-tested accessories.

## NEW LOWER PRICES

Outstanding quality and performance at prices that help you meet any competition.

**WRITE FOR FREE COPY**

**JOHN MECK INDUSTRIES**  
1313 W. Randolph St. Chicago, ILL

## POPULAR PRICE WITH REAL MUSICAL QUALITY!



It has everything you need to bring customers into your store for records and keep them coming back for more. Quality crystal pickup, self-starting silent rim drive motor (also in 25, 50 cycle and AC-DC) built in high fidelity amplifier and speaker. Even though model illustrated retails at \$14.95 the excellence of tone is so good that dealers use it as counter or booth record demonstrator. SEE and HEAR the MUSIC MASTER. Dealers write for proposition. MUSIC MASTER MANUFACTURING CO. 508 South Dearborn St. Chicago, Illinois

Order your copy NOW—the only

# P. A. HANDBOOK

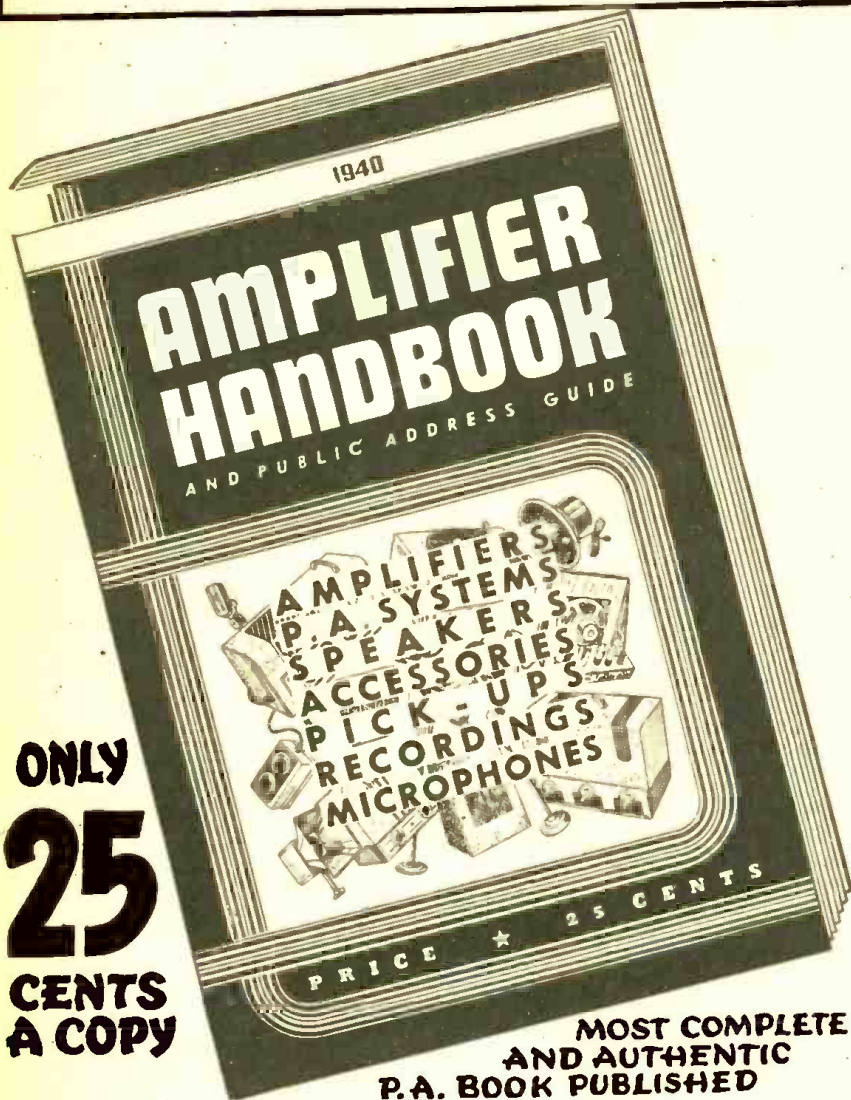

ONLY  
**25**  
CENTS  
A COPY

THAT no book has yet been published which covers amplifiers and sound systems (also kindred systems) in one complete, authentic volume is almost unbelievable. Yet, it is a fact, there is no book in print which covers Public Address from A to Z. To bridge this wide-spread gap, RAD-CRAFT will publish a complete, magnificent volume on Public Address of such magnitude—so complete and authoritative—that every man engaged in radio can have both a theoretical and practical knowledge of the function and operation of sound systems. The editorial notes are so filled with instruction and replete with illustrations that the volume fully justifies its title of 1940 AMPLIFIER HANDBOOK AND PUBLIC ADDRESS GUIDE. This great HANDBOOK on Public Address should be read and studied by those who consistently build, service and sell sound equipment.

A MATCHLESS VOLUME  
As complete as you would expect to find any engineering handbook—this is how the radio or P. A. man finds the AMPLIFIER HANDBOOK AND PUBLIC ADDRESS GUIDE. With essential technical data compiled from an exceptionally large number of sources, the volume covers nearly a hundred different subjects coordinating every conceivable branch or sub-division of Public Address.

THE CONTENTS  
To actually show the scope and magnitude of the AMPLIFIER HANDBOOK AND PUBLIC ADDRESS GUIDE, an analysis of the contents is found at the right, showing the breakdown of the material featured within each particular section. A thorough reading of the contents shows the completeness of this book.

RADCRAFT PUBLICATIONS ■ 20 VESEY STREET ■ NEW YORK, N. Y.

RADCRAFT PUBLICATIONS, INC. ■ 20 VESEY STREET ■ NEW YORK, N. Y. RC-241

Gentlemen: Enclosed find my remittance of 25c for which send me POSTPAID, one copy of your NEW—1940 AMPLIFIER HANDBOOK AND PUBLIC ADDRESS GUIDE.

Send me ..... others, for friends, also POSTPAID @ 25c each.

Name ..... Address .....

City ..... State .....

Remit by check or money order; register letter if you send cash or unused U.S. Postage Stamps.

## A Resume of the Contents of the AMPLIFIER HANDBOOK AND PUBLIC ADDRESS GUIDE

### FOREWORD

### INTRODUCTION

Definitions—decibels, frequency, input, output, impedance, etc.

### SECTION I—SOURCE

Carbon microphones (single-button and double-button)  
Condenser microphones  
Velocity (ribbon) microphones  
Dynamic microphones  
Crystal microphones (sound-cell types, crystal diaphragm types)  
Cardioid microphones  
Contact microphones  
Phonograph pickups (magnetic types, crystal types)

### SECTION II—AMPLIFIERS

#### Voltage Amplification

Design of resistance-coupled voltage amplifiers  
Commercial voltage amplifier

#### The Power Stage

Class A amplifiers  
Class AB amplifiers  
Class AB<sub>1</sub> amplifiers  
Class AB<sub>2</sub> amplifiers  
Class B amplifiers  
When to apply class A, AB, and B amplification

#### Power Supplies

Half-wave rectification  
Full-wave rectification  
Voltage doublers

#### Filter Circuits

Power supply regulation, etc.

#### Practical Hints on Amplifier Construction

Microphonism  
Placement of components  
Tone compensation  
Inverse feedback  
Remote control methods

### SECTION III—DISTRIBUTION

#### The Loudspeaker

Dynamic speakers  
Speaker performance (frequency response, efficiency)  
High-fidelity speakers

#### Speaker Baffles and Housings

Outdoor speaker installations  
Power cone speakers  
Radial (360° distribution) speaker baffles

### SECTION IV—COORDINATION

Input impedance matching  
Matching speakers to P.A. installations

#### Phasing speakers

Effect of mismatching speakers to amplifier output

A typical P.A. installation (in a skating rink)

### SECTION V—USEFUL PUBLIC ADDRESS DATA AND INFORMATION

Speaker matching technique  
The ABC of Db., VU, Mu, Gm and Sm  
Charts and formulas useful to the practical P.A. sound man  
Handy index to important articles on public address and sound

Order Your Copy NOW—

*Clip Coupon and  
Mail Today!*

# MODERN MICROPHONE TECHNIQUE

*Presented here is the first of a series of 3 articles, specially prepared for Radio-Craft readers, designed to answer many questions on the choice and use of microphones; the amplifier input considerations in public address work; and, home and commercial (and transcription) sound recording. It is felt that this article, which has been prepared with the cooperation of sound specialists in every branch of the field, fills a long-felt need of technicians generally for concrete, applicational information on this topic. Part I analyzes Crystal, Dynamic, Velocity and Cardioid microphones.*

## PART I—The Microphone

L. FLETCHER AND H. S. MANNEY



APPLIED TECHNIQUE

The young lady in this illustration is shown gauging her distance from the RCA directional dynamic microphone (type 481B2) in order that the desired song quality will be reproduced.

**T**O use the term "microphone technique" in its largest sense involves much more than the mere handling of the microphone. Actually microphone technique includes problems of amplification and acoustics, and even problems of showmanship. While it is perfectly true that a good microphone may make or break a pick-up, so many other factors are involved in any work in which a microphone figures, that any article discussing microphone technique must discuss them as well.

In the following series of articles, an attempt will be made to do this. It may be stated at once, however, that microphone technique discussed here will not include

broadcasting or professional recording techniques. Rather, we will consider only those fields which are of more vital interest to Radio-Craft readers—in brief, (1) P.A. work, (2) home recording, and (3) the commercial recording done by the smaller firms, including "transcription" work and the making of semi-professional discs.

### "WHAT 'MIKE' SHALL I BUY?"

Though it must eventually branch into other aspects, microphone technique must naturally start with a discussion of the microphone. What microphone is ideal for what type of work, and why? Here, the utmost confusion has long reigned.

The average technician setting out to purchase a microphone is confronted with a welter of catalogues, microphone models, and advertising promises. Microphones on the market today range in price from \$2 to \$200. They include at least 4 basic classifications, and infinite models within those classifications. Each manufacturer insists that his particular microphone has all the virtues. To add to the confusion, there seem to be no formal authorities on the subject. Even among well-known engineers, one finds violent prejudices in favor and against each of the microphone types. In general, the subject of microphones seems to be just about as controversial as politics or religion. Each man likes his own, and nothing can be done to change his mind.

*Before discussing the merits and demerits of the 4 basic mike types now on the market, let us make it clear first of all that fundamentally all good microphones have good pick-up, and with proper handling may be used for almost any kind of job.*

The technician with \$30 or \$40 to spend on a microphone can't go far wrong, whether he selects a crystal, velocity, or dynamic, for the manufacturers of any of these types are all turning out excellent

microphones in that price range. If he devotes time and trouble to a suitable amplifying set-up as well—that is, one designed to bring out the best qualities in the microphone he selects—he can achieve beautiful, high-fidelity reproduction with any one of them. This, however, is getting a little far afield, and first it might be wise to consider the 4 basic mike types, as they are in the pure state, regardless of special de luxe quality and amplification.

### 4 BASIC MICROPHONE TYPES

Aside from the carbon microphone, which does not enter into our present discussion, the oldest microphones of the types now generally used are the Crystal and the Dynamic. During the past few years, the crystal microphone in particular has been considerably maligned for its "mikey" quality, and its tendency to blast on the high frequencies. Most of this has been due to poor amplification, but at the same time, there are certain characteristics inherent in the crystal microphone, which have helped to bring on this criticism.

**Crystal.**—Today, there are 2 general types of crystal microphones on the market: (1) the sound-cell type, and (2) the dual-diaphragm type.

The sound-cell which uses only Rochelle salts for the pick-up of the sound-waves is the more primitive of the two, and does not have as flat a frequency response as the more complicated dual-diaphragm type. Being more efficient in the higher frequencies, it tends to overload the amplifier sooner, causing feedback. However, it has a high output, is rugged (except for the fact that it cannot stand a direct heat of more than 125 deg. F.), and is non-directional, with a wide pick-up range. It is well known for its high impedance, few sound-cell crystals being useful on cables any longer than 100 feet.

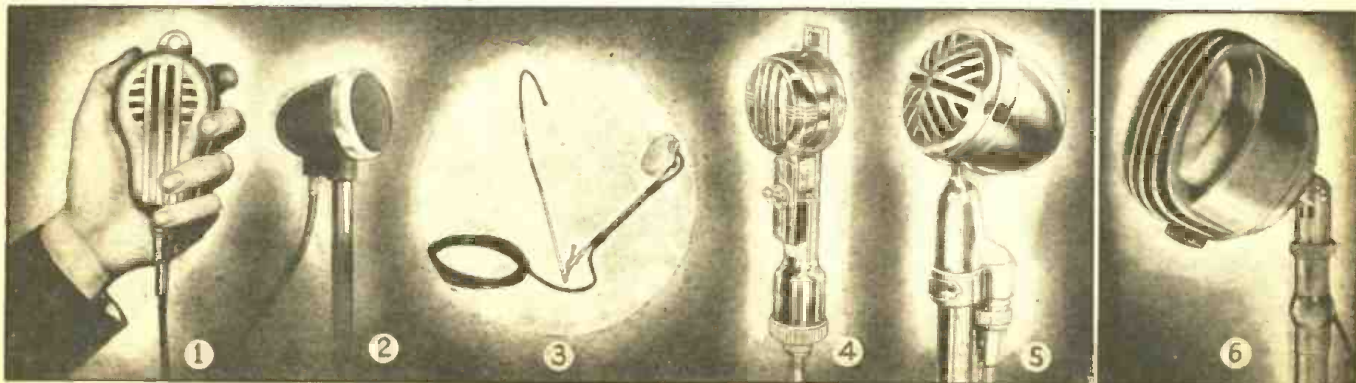

CRYSTAL MICROPHONES

This group of modern crystal microphones serves to convey some idea of the exterior appearance of representative types now on the market. They are individually identified as follows: 1, Turner "Han-D" 9X; 2, Tibbetts BH-50; 3, Universal "Ham Communications" chest type; 4, Universal "Handi-Mike" (with switch); 5, Astatic UT-48; 6, Brush AP (tone control underneath).

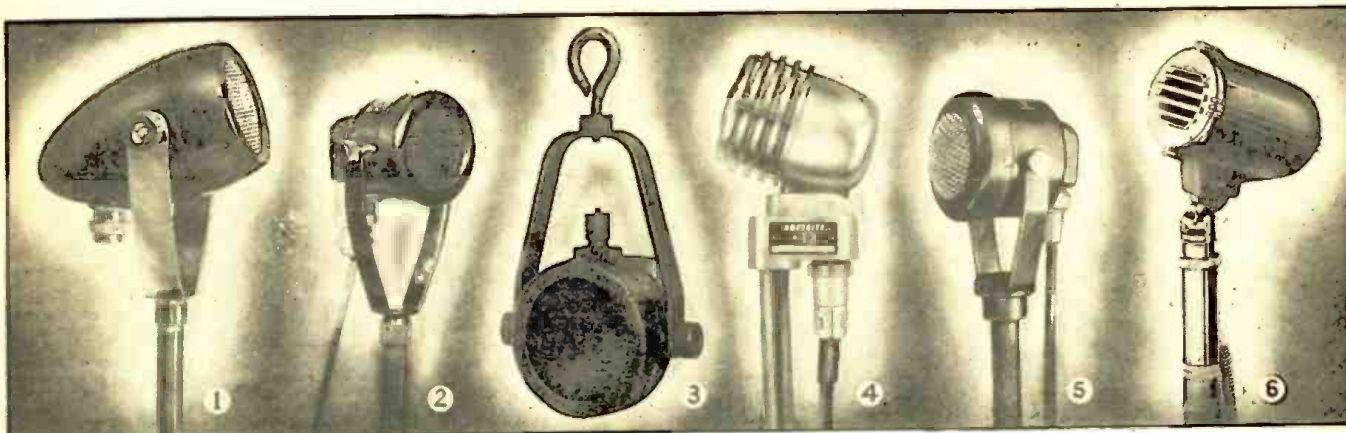

DYNAMIC MICROPHONES

Various modern designs in dynamic microphones are illustrated in these representative types. The makes are identified as follows: 1, Lektra Labs. TR-56 "Bullet"; 2, Carrier 702.D; 3, Western Electric A94; 4, Amperite PG "Pressure-Gradient" (with switch, and cable connector); 5, Tuner 99; 6, Astatic DN.

Summing up its characteristics, we find the following:—

- (1) Non-directional.
- (2) Wide pick-up range.
- (3) High output.
- (4) Rugged (except for heat over 125 deg.)
- (5) High impedance.
- (6) Peaking in the high frequencies. Usually good only from 30-5,000 cycles.

The dual-diaphragm type has been designed to increase the all-around usefulness of the crystal microphone. It consists of several small annular ring diaphragms, used in connection with selected graphoil crystal elements and dual driving yokes. The diaphragms are smaller in diameter than the wavelength of the highest-frequency waves encountered in high-fidelity applications, and thus the mike cannot be acoustically overloaded. According to the manufacturers, a good dual-diaphragm type has a flat frequency response from 30 to 10,000 cycles. There is a slight rising characteristic after 6,000 cycles, however, even in this improved type of crystal microphone.

The dual-diaphragm crystal has a much higher internal capacity than the sound-cell type, and some of the better models can even be used on cables 500 feet long. As far as sturdiness is concerned, such microphones behave much the same way as the sound-cell types. Like the sound-cell types, they are also non-directional. In other words, they behave very much like the human ear, picking up sound sometimes within a radius of 20 or 30 feet.

Summing up, we have the characteristics of this microphone type:—

- (1) Non-directional.
- (2) Wide pick-up range.
- (3) Lower impedance than sound-cell. May be used on cables 500 feet long.
- (4) Fairly flat frequency response, with slight rise after 6,000 cycles.
- (5) Sturdy.
- (6) Cannot be acoustically overloaded. Reduced feedback.

**Dynamic.**—The *Dynamic* microphone is the most efficient and has the highest output of all mike types. It may be used on a cable 5,000 feet long.

Basically, its construction consists of a moving coil operated by the pressure of the air particles in the sound wave. Its frequency response does not have a rising characteristic in the upper frequencies, like the crystals, but tends to be rather peaky in the middle registers. Engineers have worked to flatten out these peaks, and in those dynamics where the amplitude follows the air particle velocity, such as the Pressure-

Gradient dynamic of one well-known make, the response is much flatter.

Most dynamics are non-directional by nature, although they may be used in a directional way, depending upon the tilt and baffling. The dynamic is the most rugged of all microphones, being able to withstand rain, wind, and heat. Occasionally a change of pressure will affect it, but the more modern dynamics are built to withstand even pressure changes.

Summing up, we have:—

- (1) Non-directional, with directional possibilities.
- (2) Wide pick-up range.
- (3) Very rugged.
- (4) High output.

**Velocity.**—Third, and in general, most popular, of the microphone types on the market today, is the *Velocity*. This, like the dynamic, is also a *pressure-operated* microphone, the sound-waves in this instance, impinging on a thin metal ribbon, and causing it to vibrate. By its very nature, the velocity microphone is directional in its pick-up. Most velocities on the market are bi-directional, though a special uni-directional velocity has been developed, which has a pick-up angle in front of 120 deg., and is "dead" at the back.

The velocity has the flattest frequency response of any microphone on the market, as far as the higher and middle frequencies are concerned. Its lower frequencies tend to over-reverberation, and the microphone

must be properly handled so as to prevent "booming" in the bass. It is effective from about 50-10,000 cycles.

The velocity's output level is usually low. As for ruggedness, nothing very much affects it except wind. When used outdoors, the thin and sensitive ribbon tends to vibrate, causing a humming in the mike. This may be partly helped by covering the mike with a "wind-screen," made out of fine silk mesh.

We may sum up its characteristics as follows:—

- (1) Directional.
  - a. Bi-directional. Pick-up angle of about 50 deg. front and back. "Dead" on both sides.
  - b. Uni-directional. Pick-up angle 120 deg. in front. "Dead" at back.
- (2) Flat frequency response, except in lower frequencies.
- (3) Fairly low output level.
- (4) Fairly rugged, but affected by wind.

**Cardioid.**—The so-called *Cardioid* type of microphone was invented especially for P.A. work. It is the most expensive of all microphones now on the market. In construction, it consists of 2 microphones in one—usually a moving-coil (pressure) dynamic type, and a bi-directional ribbon velocity type. These, working together, produce a "cardioid" or heart-shaped pattern of pick-up. This microphone is highly directional, with a wide practical pick-up angle of 120 deg. Its peculiar construction enables it to

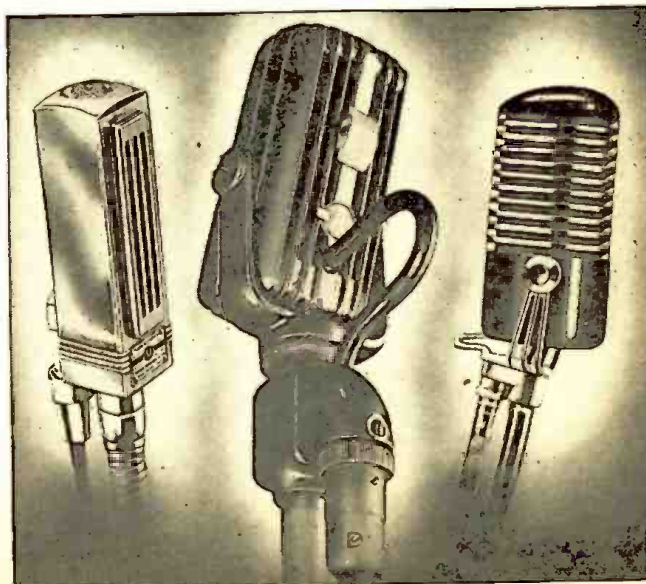

VELOCITY MICROPHONES

The new velocity-type microphones shown here are identified, left to right, as follows: Universal "5 mm." Series; Amperite RBHK (with "acoustic compensator"); Webster-Chicago "Uni-Vel" (and "Duo-Vel").

eliminate echoes and "feedback" from many points in the auditorium.

Pick-up on this microphone, though extremely wide, is even, and from tests made at WOR and the Columbia Broadcasting System, it does not seem to suffer from the over-reverberation in the lower frequencies for which the velocity is famous, but produces a clear, natural tone throughout its range.

The microphone, in one make, is equipped with 3 switches—one of which produces the cardioid pattern of pick-up—another, the simple bi-directional velocity pick-up front and back—and the 3rd, the simple, non-directional dynamic pick-up. It is thus highly adaptable to many different situations.

It is a particularly rugged microphone, a specially-constructed stiff ribbon in the velocity unit having been designed to reduce wind noise to a level approximately 10 db. lower (in one make) than that of a regular ribbon mike. The housing of the microphone also acts as a wind screen.

The impedance of this microphone is low. Its output is relatively high.

Summing up, we find its characteristics as follows:—

- (1) Directional.
- (2) Wide angle of pick-up. 120 deg., without any loss in clarity.
- (3) Flat frequency response. 40-10,000 cycles.
- (4) High output.
- (5) Low impedance; or, in crystal type, high-impedance.
- (6) Rugged.

The above summaries of the 4 basic microphone types, while not exhaustive by any means, are yet indicative of some of the characteristics the technician should consider when purchasing a microphone. With these distinctions well in mind, let us then proceed to an analysis of the requirements needed in the various types of work where microphones are used outside the broadcasting field. Perhaps by comparing these requirements with the mike characteristics as shown, we can arrive at a more definite idea of each mike type's basic place in the scheme of things.

**PUBLIC ADDRESS USE**

Public address system work is so highly varied that at first glance its requirements seem impossible to define. There are a number of essential characteristics required of



MORE DYNAMIC MICROPHONES

Illustrated at left is the Turner type 9D microphone (with banquet stand). At right, the Webster-Chicago "Super-Dyne."

# Sound System Men Praise Airline SOUND SYSTEMS

You can depend upon the opinion of men who KNOW sound systems and who insist upon sound system performance. Here is what a few of them say about the Ward Airline: "Working perfectly—no repairs of any kind"! "Big volume—tone clear and natural"! "Customers greatly pleased at uninterrupted service"! "Natural tone and large coverage"! "Installed amplifier in tower of large church; was heard nearly 4 miles in the country"! "Most natural I ever heard in tone and range"! And hundreds more along the same line! Remember that due to Wards direct selling plan, no other sound system could produce such results at anywhere near the price of the Ward Airline.

**WRITE FOR CATALOG**

The new Ward Catalog gives you important facts about Sound Systems... what you can expect from an Airline; what speakers, amplifiers and mikes to select for best results; how everything plugs together, providing utmost simplicity in setting up and taking down. Mail coupon for FREE copy!

**TIME PAYMENTS 15-DAY TRIAL  
MONEY BACK GUARANTEE**

*Montgomery Ward*  
9 GREAT MAIL ORDER HOUSES  
MORE THAN 600 RETAIL STORES



MONTGOMERY WARD & CO.

Dept. RZ-42, Chicago, Ill.

Please send your Airline Sound System Catalog at once.

Name \_\_\_\_\_

Address \_\_\_\_\_

State \_\_\_\_\_

all P.A. microphones regardless of whether they are to be used indoors or outdoors.

First, it is extremely essential that a P.A. mike have a flat frequency response, in other words, reproduction should be as natural as possible. A good P.A. system should never give the impression that a mike is in evidence. Nothing is more obnoxious than a blaring, "mikey" P.A. system. With flat frequency response, there are few peaks, and therefore no "singing", or feedback.

Second, most P.A. mikes should be directional—that is, they should pick up only the source of sound which requires amplification. On most P.A. jobs there are many other noises in the auditorium or stadium besides the sound-source at the mike. Outdoors, there are often street noises, sometimes echoes from a concrete stadium, audience noise, and applause. Indoors, particularly in theaters, night-club work and banquets, there are extraneous noises like applause, opening and shutting of doors, the rattling of dishes, whispers, etc. A non-directional mike which acts like the human ear, cannot help but pick up these sounds. Of course this is not true of all P.A. work. Sometimes the speaker whose voice is being amplified is isolated from other sounds, as for example, an announcer at a race-track or a baseball game, who is generally enclosed in an acoustical booth. In such a case, a non-directional microphone would be quite all right.

Third, the P.A. mike should not only be directional, it should be uni-directional. A bi-directional microphone would pick up extraneous audience noises, feedback, echo, and the like, at the back. Of course, bi-directional microphones are sometimes used on P.A. jobs, particularly in picking-up symphony orchestras, but in such cases some compensation must be discovered for their bi-directional nature—such as, hanging them high above the audience, and tilting

## NOW-Recording at Home

**New! GI-R70** Voice-Instrumental Simplified-Low Cost



• Priced for average home buyers—easy to operate—highly efficient—the new GI-R70 makes home recording popular. Ready for quick installation. Powerful motor and weighted turntable; high-impedance tangent-tracking crystal pickup; concealed feed crew; top-quality cutting head and arm. Get a sample to test. Order from your Jobber.

**The GENERAL INDUSTRIES CO.**  
DEPT. 20 ELYRIA, OHIO



**WOODSTOCK  
TYPEWRITERS**

# NEW FM AUDIO AMPLIFIERS

Designed by A. C. Shaney

FREQUENCY RANGE: 13-30,000 c.p.s.  $\pm 1$  db  
 POWER RANGE: 0.003 to 30,000 Milliwatts  
 MUSICAL RANGE: 11 Octaves  
 DYNAMIC RANGE: 80 db

Outstanding in their performance, construction, and appearance. These amplifiers were specifically designed for use with frequency modulation tuners, standard amplitude modulation receivers, and absolute fidelity phono reproducers. Load by a wide margin the very finest resistance, impedance or transformer-coupled amplifiers. Incorporate two basic AC and DC balancing circuits (Pat. app. for) which provide greater circuit stability than conventional amplifiers.

Guaranteed for FIVE YEARS

Write for literature describing our FM Amplifiers

**AMPLIFIER CO. of AMERICA**

17 WEST 20th STREET NEW YORK, N. Y.



## ELEMENTARY MATHEMATICS

• EASY — SIMPLIFIED — PRACTICAL •

**H**ERE is a book for the business man, the technician and craftsman explaining and answering every operation and meaning with interpreting illustrations and examples.

It is the key to a simple understanding of many perplexing problems in daily life.

In clear, positive and definite language, the author popularizes and clarifies every subject and helps the reader to overcome any apparent difficulty in the study of mathematics.

A real home study-course in mathematics for the student or the man who wants to achieve proficiency or desires to brush-up on his knowledge.

Entire Chapter on Special Mathematics for the Radio Technician

### CONTENTS OF BOOK

- CHAPTER I. Arithmetic—Addition—Subtraction—Multiplication—Division.
- CHAPTER II. Factoring and Cancellation—Fractions—Decimals—Percentages—Ratio—and Proportion.
- CHAPTER III. The Metric System.
- CHAPTER IV. How to Measure Surfaces and Capacity (Geometry).
- CHAPTER V. Powers and Involutions—Roots and Evolution.
- CHAPTER VI. Mathematics for the Manual and Technical Craftsman—Trigonometry conversions—Graphs or Curve Plotting—Logarithms—Use of the Slide Rule.
- CHAPTER VII. Special Mathematics for the Radio Technician.
- CHAPTER VIII. Commercial Calculations—Interests—Discounts—Short Cut Arithmetic.
- CHAPTER IX. Weights and Measures—Useful Tables.

ONLY  
**50c**  
POSTPAID

## TECHNIFAX

1917 S. State St. RC-241 Chicago, Ill.



### WEIGHT SCALE FOR RECORDERS

For Recording Engineers, Servicemen, etc. Size of ordinary fountain pen. Attractively finished in black, white or color combinations of bakelite. Chrome pickup hook. Instantly determined weight on playback needle or cutting stylus. Indispensable because various recorder mfgs. recommend their own weight limitations on pickups and cutting heads. Proper wt. vital. Eliminates guesswork. Controls depth of cut. Prevents too shallow or too deep grooves.

UNIVERSAL MICROPHONE CO., LTD.  
INGLEWOOD, CALIF., U.S.A.



IT PAYS TO USE THE BEST!  
University's "Non-Resonant" high efficiency "Reflect" Loudspeakers will always prove most economical in the long run.

UNIVERSITY LABORATORIES  
195 Chrystie St.  
New York City

### FILMGRAPH VOICE AND MUSIC RECORDINGS

Lengthy or continuous recordings now possible with newly patented "FILMGRAPH." Over 13 hours of indexed voice, radio, code, telephone recording on a single 500 ft. reel of film costing \$3.00 and up. No other expense. INSTANTANEOUS and PERMANENT play-back. Can easily be synchronized with Motion pictures. Bulletins free.

MILES REPRODUCER CO., INC., Dept. RCB  
812 Broadway New York City

them, so that the side not facing the source of sound, faces the ceiling.

Fourth, a P.A. mike should be rugged. Indoors and outdoors, the average P.A. mike has to stand a lot of abuse. In the first place, most P.A. installations are temporary. The mike is carried about by the P.A. engineer from place to place. Second, many of the performers using P.A. systems do not know how to treat a microphone. They may handle it, pick it up, drag it along by its cord, even drop it or knock it over. On outdoor installations, a microphone often has to stand the heat of the sun, an occasional shower, humidity, and wind.

There are other minor requirements demanded by individual kinds of P.A. work, which we shall discuss later. In the meantime, let us sum up the basic requirements as follows:—

- (1) Directional. Preferably uni-directional.
- (2) Flat frequency response.
- (3) Rugged.

Now, referring back to our list of mike characteristics, is there any one microphone which fits all these requirements? The only one with a perfect score seems to be the cardioid. Running a close second to it is the uni-directional velocity, although this does not have as flat a frequency response in the lower registers as the cardioid, nor is it as rugged.

Both crystal types fall short on the fact that they are essentially non-directional. So does the dynamic. The average dynamic, though more rugged than either the velocity or the cardioid, also fails on the matter of frequency response, which is often peaky in the middle registers. However, there are some dynamics on the market which are almost perfectly flat in the entire audio range and which could be used in a directional manner. These types would be perfectly suitable for P.A. work.

After such a theoretical analysis of the situation, does this mean that the crystal and the dynamic are useless for P.A. work? Certainly not. We are speaking in this first article only of the *ideal* microphone and the *ideal* situation. Proof that the crystal and the dynamic may be used successfully with many P.A. engineers who swear by them. But, even in an ideal sense, they often have their place, in special cases, where a uni-directional or a cardioid are unnecessary.

For example, as we have said, a non-directional type of microphone, like the crystal and the dynamic may be used on P.A. jobs where the extraneous noise level is at a minimum, and the performer is close to the microphone. This would be satisfactory in a church service, or a lecture, where the audience is quiet, or at a baseball game, where the announcer is enclosed in a booth. Dynamics in particular are extremely popular for sports announcing, and indeed most of the models now on the market today

are designed for this use. For barker and paging work, both the crystal and the dynamic are excellent, and as a matter of fact, are used more than the other types in this field.

### SOUND RECORDING

The fields of *home* and *semi-professional recording* are more circumscribed as far as set-up is concerned than the field of P.A. systems. Both however are of interest to the technician, who is often called in as consultant to a small commercial record company, or asked to help out in recording a little home talent in the parlor.

**Semi-Professional.**—In the field of semi-professional (and "transcription") recording, it is quite difficult to arrive at an "ideal" microphone, merely by consulting the technicians who work for the various firms. A recent survey made by the writers showed at least 3 microphone types in use at various small studios, each of which seemed to be giving satisfaction to performers and technicians alike.

Semi-professional recording is usually done in a small, acoustically-treated studio, usually a pretty "dead" studio. Acetate or aluminum records are used. The recording equipment is generally above the average home machine. The performance ranges from singers and speakers to various kinds of instrumentalists, but the vast majority are singers, pianists, and people who merely want to hear the sound of their own recorded spoken voice.

For this work, a microphone with a wide pick-up range, great directivity, and low impedance would be out of place. Ruggedness is not essential, as the equipment stays where it is. A flat frequency response is desirable for natural reproduction but a tendency to accentuate the highs may, on occasion, prove an advantage, for the simple reason that amateur records tend to sound dead, and a microphone which slightly emphasizes the highs may achieve more clean-cut and brilliant results.

Checking back to our list of microphone characteristics, it would seem that as far as speech and instrumentalists go, the better type of crystal or dynamic should be quite adequate for this work. A crystal with a flat frequency response, might even be used successfully for music. Many of the semi-professional recording studios use crystals for piano recording, as they like the added brilliance of this microphone, in a small dead studio, and on imperfect discs.

The velocity, of course, also fills the bill, particularly for singing, where its flat frequency response stands it in good stead. However, in semi-professional recording, where the average studio is extremely dead,



**CARDIOID CRYSTAL-LABYRINTH MICROPHONE**  
The Shure "Uniplax" 730-A is a diaphragm-type unit with uni-directional cardioid characteristics (obtained through the addition of an acoustical labyrinth).

# FREE TO YOU!

## RADIO PARTS AND ACCESSORIES

HERE is some real BIG NEWS for you! Through a fortunate arrangement which we have been able to make, we can now offer you FREE premiums, of such extraordinary value that they overshadow anything we have ever offered in the past with subscription to RADIO-CRAFT Magazine.

NEVER BEFORE, in the 11 years' history of the magazine, have we offered such worthwhile premiums. All of these radio parts and accessories can be used to good advantage by the "ham" or constructor in his daily experiments.



**TELEPHONE JACK**  
Substantial long frame phone jack. 2-circuit filament control type. opens 2 circuits, closes 3rd when plug is inserted. Can be used for variety of control purposes in radio and telephone work. 2 1/2" long, 1" high. Ship. weight 4 oz.  
**Premium No. 1 (3 Pts.) Val. 35c.**



**PUNCHED CHASSIS**  
Heavy plated steel chassis with holes punched for 11 tubes, power transformer, speaker plug and tuning dial. Great for large experimental sets, transmitters, etc. Reinforced construction. 13"x7 1/2"x2 1/2". Ship weight 3 lbs.  
**Premium No. 2 (5 Pts.) Val. 25c.**



**TWO GANG POTENTIOMETER**  
Well-made Yaxley 2 gang wire wound potentiometer. 2 units are insulated from each other. One is 5000, the other is dual action volume control in experimental circuits. Ship. weight 1 lb.  
**Premium No. 3 (5 Pts.) Val. 25c.**



**ALLOY CHASSIS**  
Medium weight alloy metal chassis punched for power transformer and 8 tubes as well as numerous mounting holes. Easily drilled metal. Open ends well made. 10 3/8"x6 3/8"x2 1/2". Ship. weight 2 lbs.  
**Premium No. 4 (5 Pts.) Val. 25c.**

These parts are given to you IN ADDITION to the cut-rate subscription prices we list below:

- 7 mos. for \$1 (saving you 75c over the single-copy price)
- 16 mos. for \$2 (saving you \$2 over the single-copy price)
- 24 mos. for \$3 (saving you \$3 over the single-copy price)

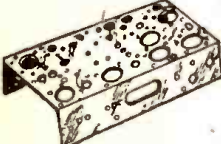

**7 TUBE CHASSIS**  
Alloy metal chassis punched for 7 tubes, condensers, etc. Ideal for building small sets or simple apparatus. Metal easy to drill. Size 10 1/2"x5 3/4"x2". Ship. wgt. 2 lbs.  
**Premium No. 5 (5 Pts.) Val. 25c.**



**CONNECTING CABLE & TERMINAL**  
Unusually well made. 8 foot, 5 wire cable with spade terminals at one end and terminal block with 8 positions at other end. Wires color coded. Well insulated. May be used for remote control or battery connections, etc. Terminal block 3"x3"x3/4". Ship. weight 1 lb.  
**Premium No. 6 (6 Pts.) Val. 35c.**

And, of course, the longer your subscription runs, the more merchandise you obtain FREE. As we expect a tremendous response to this offer, we would suggest that you send your remittance without delay, as our supply of parts is limited and we won't be able to duplicate this offer again.



**LOUDSPEAKER UNIT**  
Kellogg magnetic loudspeaker unit for use with horn speaker. Has adjustable diaphragm. May be used as pillow speaker or attached to acoustic phonograph. Also useful as sensitive intercom for voice reproduction. Threaded (3/8" diam.) phone for voice reproduction. Threaded (1/2" diam.) throat. Size 2 1/2" diam., 1 1/4" deep. Ship. wgt., 2 lbs.  
**Premium No. 7 (10 Pts.) Val. 75c.**

**IF YOU ARE A RADIO EXPERIMENTER, AMATEUR OR SERVICEMAN, TAKE ADVANTAGE OF THIS MARVELOUS OPPORTUNITY NOW!**

A SHORT while ago we were informed that one of the largest surplus houses in the East was ready to sacrifice a huge quantity of radio parts and accessories which cost the original manufacturers thousands of dollars. We entered into an agreement with this house whereby we suggested to them to allow us to offer these parts to our readers in connection with subscription offers. The surplus house enthusiastically endorsed our plan. We—the publishers—pay the surplus house cash for each of these parts, and you—the reaper of this fortunate arrangement—will get these valuable radio parts and accessories ABSOLUTELY FREE. This is positively the first time that we have been enabled to make such an unprecedented offer which in many ways sounds too good to be true. Nevertheless, we vouch for it in every way and we know you will not be disappointed. This special arrangement enables us to offer you this valuable merchandise FREE with your subscription to RADIO-CRAFT magazine, at a price which is already a tremendous saving over the newstand cost. This is how the plan works:—Next to the premium number of each item, we show its point value.

- For each 7 months' subscription (\$1.00) you receive 15 points' worth of merchandise free.
- For each 16 months' subscription (\$2.00) you receive 30 points' worth of merchandise free.
- For each 24 months' subscription (\$3.00) you receive 45 points' worth of merchandise free.

For instance, if you send us a seven months' subscription at \$1.00, you are entitled to 15 points' worth of free merchandise. You may order one No. 4 (5 points) and one No. 7 (10 points). Or if you wish, one each of numbers 2, 3 and 4 (each 5 points), or any other combination which totals 15 points. Similarly, if you send us a 16 months' subscription (\$2.00) you may order any combination of merchandise which totals 30 points. On a 24 months' subscription (\$3.00), any combination totalling 45 points. Due to the high cost of the merchandise, we cannot ship the articles

prepaid, therefore we show the weight of each piece, packed. If you wish your free parts sent by parcel post, please add to your remittance a sufficient amount to cover postage. Or, if you would rather have us send the parcel express charges collect, we will be glad to do so. Please remember that we do not sell these articles. You cannot buy them from us at any price. In order to make sure that you receive your Parts promptly, ORDER TODAY. Fill out the coupon, clip and mail to us together with the proper remittance.

**ALL RADIO PARTS ARE NEW AND UNUSED Many are in their Original Packing**

**IMPORTANT TO PRESENT SUBSCRIBERS**  
If you are already a subscriber or have recently subscribed to the magazine, this offer still holds good for you, too. We merely will lengthen your subscription for either 7 months, 16 months or 24 months, as the case may be. There is a place on the coupon which provides for this.

**RADIO-CRAFT, 20 Vesey Street, New York, N. Y. RC-241**

Please enter my subscription to RADIO-CRAFT for

7 months—\$1.00, Plus 15 points' worth of FREE radio parts. Canadian and foreign countries add 32 cents for \$1.00 subscription; 72 cents for \$2.00 subscription; \$1.08 for \$3.00 subscription.

16 months—\$2.00, Plus 30 points' worth of FREE radio parts.

24 months—\$3.00, Plus 45 points' worth of FREE radio parts.

I enclose my remittance for \$..... which includes parcel post charges on the FREE parts I am ordering.

Please send the merchandise to me express charges collect.

I am a new subscriber.  Extend my present subscription for ..... months.

I am circling the numbers of the parts I wish to have you send me Free.

Nos. 1 2 3 4 5 6 7

Name ..... Address .....

City ..... State .....

(Send remittance in form of check or money order. If you send cash or unused U. S. postage stamps, be sure to register your letter.)

**DON'T MISS THIS OPPORTUNITY! WE ASSURE YOU THAT YOU WON'T BE DISAPPOINTED. ORDER TODAY! SIMPLY FILL OUT THE COUPON. PROMPT SHIPMENT ASSURED!**

**RADIO-CRAFT**  
20 VESEY STREET  
NEW YORK, N. Y.

**STEP UP YOUR SHOP PROFITS with Atlas EQUIPMENT**



**EASY TO OPERATE**

It's easy to turn out your own machine work on an Atlas Lathe—and make for yourself the profits you now have to pay others.

Radio Servicemen in all sections find that the Atlas Lathe makes quick work of dial shafts and drums, knobs, special screws and studs; service tools, microphones, special dies and molds. Operating instructions show correct gear set-ups for winding R.F., choke, and short wave coils, transformers.

**Send Coupon for FREE 1941 Catalog**

See the many operations you can do in your own shop with Atlas Equipment. Send the coupon below today for full details.



LATHES • DRILL PRESSES • ARBOR PRESSES  
METAL SHAPERS • VISES • CIRCULAR SAWS

ATLAS PRESS CO.  
245 N. Pletcher St., Kalamazoo, Mich.

Please send me your 1941 Catalog on  6" Metal Lathes  10" Metal Lathes  New Milling Machine  7" Metal Shaper  Drill Presses  Arbor Presses.

Name .....

Address .....

City and State .....

How Many Books in the Radio-Craft Library Series Have You Read? See Page 454.

**WORLD'S GREATEST all around ELECTRIC TOOL**

DRILLS—GRINDS—SANDS—SAWS  
POLISHES—SHARPENS—CARVES

The new WHIZ ELECTRIC TOOL is the handiest power tool ever made. A rugged tool for power and precision work. Drills through 1/4 inch iron plate in 42 seconds or engraves intricate designs. Handles any material: Metals—Woods—Alloys—Plastics—Glass—Steel—etc. Saves time. Eliminates labor. Plug into any socket AC or DC. 110 volts. Chuck 1/4 inch capacity. Ball bearing thrust. Powerful, triple-gear motor. STANDARD MODEL with Normal Speed (uses 200 different accessories, instantly interchangeable). Price only \$7.95. The only DRILL-TOOL with a full year's guarantee.

**FREE** Accessory outfit (Value \$2) includes set of drills, mounted 1 1/2 inch grinder, sanding discs, cutting wheels, mounted brush, polishing wheel, carving bur, etc. FREE with each tool ordered NOW. We pay postage.

10-DAY TRIAL—MONEY BACK GUARANTEE.  
PARAMOUNT PRODUCTS CO.  
Dept. 2RC, 545 Fifth Ave., New York

it has a tendency to produce a rather dull record, and it is wise, if one chooses this microphone, to liven up the acoustics of the studio before making the record.

A bi-directional velocity is of course useful, particularly when there is more than one performer, but a crystal or a dynamic with a tilting head may be used perfectly well, to pick up quartets and small orchestral ensembles.

**Non-Professional.**—The selection of a microphone for home recording is usually outside the sphere of the average technician, as most home recording sets come already equipped with microphones. Usually this is a crystal type. The inclusion of a crystal microphone in home sets has been annoying to many people, who claim that the manufacturer provides this type of microphone, not because it is ideal for the work it has to do, but because the crystal is the cheapest mike on the market. This is partly true, but not altogether so.

What does a home recording microphone require? Most home recordings take place in the family parlor, where the acoustics are usually deadened by the presence of much overstuffed furniture, heavy draperies and rugs. Second, the recording equipment is probably of a much lower standard than the professional or semi-professional equipment. It has to be to come within the price range of the average consumer. This inferior quality generally shows up most in the cutting head, which is seldom very efficient particularly in the higher frequencies. The records are of aluminum, where there is a good deal of surface noise. (\*)

Obviously such a set-up does not call for a microphone with a perfect frequency response, great directivity, and wide pick-up range. It calls, rather, for a microphone, whose "weaknesses" are in reality advantages, once they are coupled with the weaknesses of the equipment itself. We are not making out here, any case for the very-low-price, so-called "cheap" crystal microphones, but it is perfectly true that on occasion their decided "rising characteristic" in the higher frequencies compensates for the deficiencies of the cutting head in recording these higher frequencies. Secondly, their high output, their "shrillness" so to speak makes up for the dullness of the studio and the record itself. Third, whatever "mikey" quality they may have may not be noticeable in the average home-made record, which usually has a high level of surface noise.

However, this does not make for beautiful home recording, by any means. Even in

(\*) The question of surface noise when recording on aluminum is subject to certain qualifications, as discussed in the multi-part article, "Profits in Recording," in the May and June, 1940, issues of Radio-Craft.—Editor



**CARDIOID DYNAMIC-VELOCITY MICROPHONE**

The Western Electric 639-B multi-directional 6-pattern microphone is controlled for pattern (including cardioid) by a screwdriver. Thus it can be adjusted to suit the reverberation pattern of any location.

the better class of home equipment there is still a good case to be made out for use of the better-grade crystals and dynamics. Though not as flat in their frequency response as the velocity, this trait means less than in semi-professional and professional recording. On the other hand, their definite virtues of high output, sensitivity, and ruggedness count for a great deal. They are also easier to handle than the more temperamental velocity, and this, when one considers the amateur quality of the performers who use them, means a great deal.

**SUMMATION**

The findings above are little more than a mere sketching-in of several points about microphones and their ideal suitability for certain types of work outside the field of broadcasting. The conclusions drawn may seem arbitrary to many readers, and indeed, they are true only inasmuch as they refer to the microphone itself. The writer, however, is fully conscious that the microphone, important as it is, is only one unit in a system, and that the other units in that system, by their very nature, may be able to change the characteristics of that microphone so that it behaves in a radically different way from its true self. Indeed, in the hands of an experienced technician, the personality of a microphone per se may mean very little, in fact, it may become completely unrecognizable. This is also an important aspect of microphone technique—and in the following article will be more fully explained.

*Don't Miss Part II Next Month.*

**NEWS SHORTS**

Striving hard to put over to laymen the fact that its new Port Washington, Long Island (New York), transmitter location is something real special, station WEAF in a 2-pg. ad in *Broadcasting* commented as follows:

"Just as the sounding board of a fine piano multiplies and enriches the depth and beauty of a measured chord, a treble run or a single sharp note, so WEAF's new sounding board—it's salt-water-way into New York—will multiply and enrich the value of your programs as they speed into the world's most thickly populated area."

Going back to more elementary verbiage, the ad continues: "For salt water is the best conductor of radio waves and WEAF's

new transmitter location takes complete advantage of this natural phenomenon." Whatever the reason, WEAF now rates a push-button on sets that previously received this station but poorly.

The truism that "increased Turnover means increased Sales—and Profits," is the theme of Bright Star Battery Company's newest colored folder illustrating their extended line of drycells, batteries, and flashlights. Of exceptional interest is their new streamlined, copper-and-chrome design, a flashlight pattern available in standard and special types, including Prefocused and Baby Spotlight models.



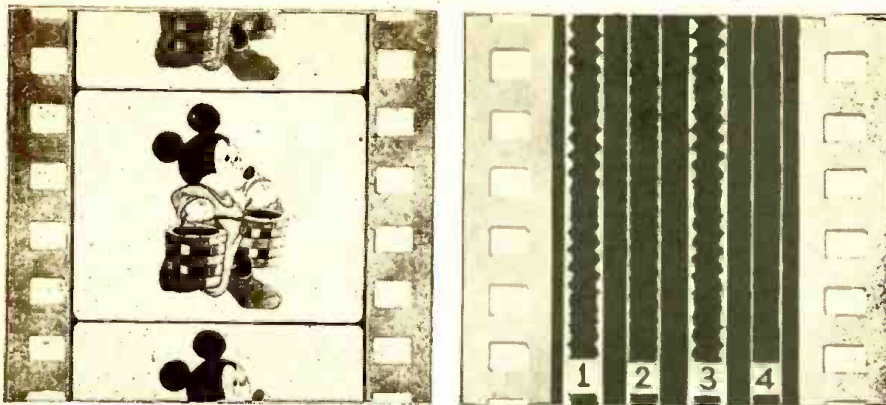

Photo (left)—Walt Disney Productions

World-famous little Mickey Mouse, in a particularly beguiling pose in a scene from "The Sorcerer's Apprentice", one of the sequences in "Fantasia", is shown at left. Note that this PICTURE-FILM carries no sound track; instead, a second or PHONO-FILM (shown at right) carries the sound tracks for the picture. Tracks 1, 2 and 3, feed the 3 on-stage high-fidelity channel speakers (shown in one of the accompanying photographs) and the series of auxiliary loudspeakers (shown in the block diagram of the theatre sound installation). Channel No. 4, extreme right, shows only slight variations, but these are sufficient to control the dynamic range of the reproduced sound. (The phono-film shown here was clipped for Radio-Craft from Beethoven's "Pastoral" [6th] Symphony.)

A new era in talking motion pictures is being introduced by the \$2,200,000 production "Fantasia." This fantastic color picturization of musical masterpieces heard in new interpretations of tone and volume includes a \$200,000 sound-recording set-up and a \$30,000 theatre 3-dimension sound system. Amplifiers, loudspeakers, photocells, an interphone, and a disc recording system, are used as here described.

## "FANTASIA" INTRODUCES "FANTASOUND"

THE first public showing (November, 1940) of Walt Disney's "Fantasia," in the Broadway Theatre, New York City, unveiled an entirely new type of motion picture sound recording and reproduction, in Multiphase Technicolor, which projected a 3rd-dimension effect of sound and music.

### DIRECTIONAL SOUND

"Fantasound" plays an enormous part in "Fantasia." The music of the 103-piece Philadelphia Orchestra under the baton of Leopold Stokowski is the chief and sometimes the only actor.

Christened "Fantasound" because, like the picture itself, it represents a revolutionary technique in sound reproduction, the new system of recording and reproducing sound-on-film employs entirely new principles both in the studio production and in theatre presentation. Three years of work by Disney and RCA engineers went into its developments.

The studio dispatched a crew of technicians and studio musicians to Philadelphia's historic Academy of Music, where the business of recording the Philadelphia Orchestra was carried on. Over 420,000 feet of music were recorded, from which 18,000

were to be selected for the final picture.

For every group of loudspeakers used in the theatre, there had to be a separate source of sound synchronized with the picture. So when Mickey Mouse appears on the right, a control mechanism switches on the loudspeaker directly behind him and veers the sound to another speaker when he moves.

Stokowski directed as he would ordinarily and the orchestra played with its familiar fire and skill. But there all convention ended. For the music had to be divided up in such a way that later it could be blended at will and reproduced through the required loudspeaker—wherever Disney wanted it.

The RCA "Fantasound" system differs from a standard motion picture sound reproducing system in that 3 channels, complete from phototube to loudspeakers, are used instead of 1. Three groups of loudspeakers are located to the left, center and right of the screen (see photo), and others are installed at other strategic locations in the Broadway Theatre. A separate sound track is provided for each channel, so that it is possible to make the sound come from different parts of the screen or stage, or even from different parts of the auditorium.

### AUTOMATIC VOLUME CONTROL

In addition to the 3 program sound-tracks, a 4th, known as the control, or "cue", track is used. This is merely a recording of 3 different single-frequency tones of varying intensities. When the film recordings

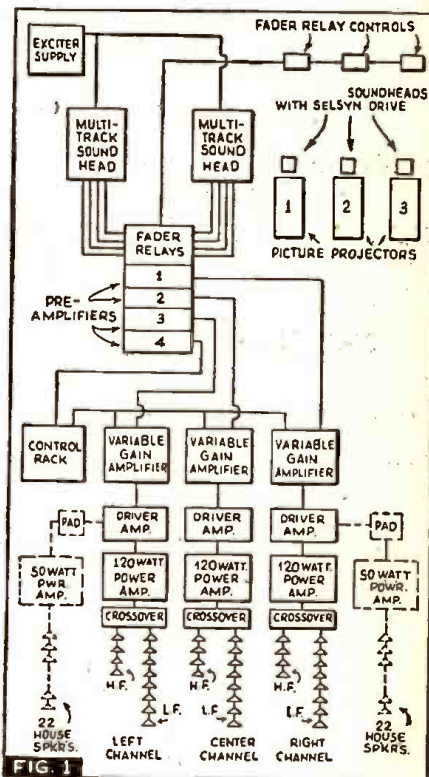

Fig. 1. Simplified block diagram of the "Fantasound" reproducing system. It should be kept in mind that in the Broadway Theatre installation in New York the house speakers indicated (dotted) on the right and left sides of the diagram are not installed in quite this manner although they were part of the system when it was installed in the Disney Studios in Hollywood. In New York, the arrangement is: orchestra, 16 low-level cone loudspeakers at rear, and 3 more on either side; balcony, 2 medium-power hi-fi cone and honeycomb-horn combinations at rear and 2 more on either side, and 16 low-level cone speakers on either side. Thus every seat is literally "bathed" in non-directional or directional sound, as desired, by using these house speakers and the 3 on-stage channels.



Technicians at work during the recording, in the Academy of Music, Phila., Pa., of the 103-piece Philadelphia Orchestra 2 1/2 years ago for "Fantasia." Six sound engineers known as "mixers" worked under the direction of a Disney staff musician. Each mixer represented an individual orchestral channel and it was the responsibility of these men to regulate the sound of the music before it reached the cordist to prevent overloading or under modulation, on the film.

Photo—Walt Disney Productions



The 3 special super-power high-fidelity loudspeaker assemblies in back of the picture screen on the theatre stage. A heavy hair-cloth curtain in back of the speakers absorbs the back waves. Each 15-ft.-high bay includes a group of 8 L.F. speakers topped by a 4-horn-unit honeycomb-type H.F. projector. (See Fig. 1.)

are reproduced, the 3 control tones are amplified and then separated by a system of electrical filters. Each tone passes on to a special variable-gain amplifier, one of which is located in each amplifier channel. These amplifiers are so designed that their amplification depends on the strength of the control tone which reaches them. Thus, the control tones in conjunction with the variable gain amplifiers act as automatic volume controls for the 3 amplifier channels. *By increasing the intensity of one tone with respect to the others, it is possible to make the reproduction from one set of speakers louder than that of the others.*

The principal value of the control track is that much greater volume or dynamic range can be obtained in reproduction than it is practicable to record on the film. This is made possible by the provision for automatically varying the amplification of the amplifier channels.

The volume range that it is practicable to record on film is physically limited to a value considerably smaller than that of a symphony orchestra, where a single flute or violin may carry the melody, followed by the crashing crescendo of the entire orchestra. Because these loud passages would otherwise "overshoot" the sound-track, it is necessary to record them at greatly reduced volume. Thus, the volume range must be "compressed" during the recording process. But the volume range of the reproduction may be automatically restored through the use of the control track system.

*This system can make the volume range of the reproduction as much as 10,000 times that of the reproduction of the same recording over a conventional sound reproducing system! The result is a fullness and dynamic expression in music that has never before been known in theatre reproduction or in any commercial sound-on-film system.*

Obviously, there isn't room enough on a conventional film, which ordinarily carries a single sound track, to record the 3 program sound tracks, the control track and the picture. Hence, the picture was recorded on one film, and the sound tracks on another.

In reproduction, the 2 films are run in synchronism. The sound film is run through a special multi-track soundhead (or "film phonograph" as it is more properly called) kept synchronized with the associated picture projector by means of a selsyn-type motor drive.

The film phonograph has 4 phototubes, one for each sound track. The 3 which receive light beams transmitted through the program sound tracks are connected to the 3 main amplifier channels. The phototube associated with the control track is connected to an amplifier and filter system which am-

plifies and separates the 3 control tones and directs each to the proper variable-gain amplifier.

### HIGH-POWER SOUND SYSTEM

The rated power output of the amplifiers in each main channel is 180 watts. However, it was found in tests that each delivered 200 watts, or 600 watts total for the 3, with under 2% distortion. In addition, there are two 50-watt auxiliary amplifiers, one for each channel, which operate small cabinet-type loudspeakers distributed about the auditorium (see Fig. 1).

This gives a total of 700 watts of audio power with negligible distortion. This is staggering in comparison with the 10 to 40 watts now used in the average theatre. Such power is required to take full advantage of the unprecedented volume range which the system provides.

To handle this tremendous power, 3 de luxe loudspeaker systems are used on the stage. Each is of twice the size and has twice the capacity found in the average de luxe theatre. *A total of 24 low-frequency speaker units and 12 high-frequency speaker units are used in these 3 loudspeaker groups alone!* Spreading the sound across the stage with 3 speaker systems gives a vastly better illusion of reality when reproducing the sound of an orchestra (or off-stage sound effects) than is possible with a single sound source.

Returning once more to the devices employed in making the original sound recordings and correlating them with the accompanying pictures we find that many innovations were required.

### RECORDING

The block diagram of Fig. 2 indicates the equipment arrangement of the multiple channel recording system used at the Acad-

emy of Music, Philadelphia, Pa., to record the music for "Fantasia." Refer, also, to Fig. 3 that illustrates a type of sound-film which never left Hollywood.

There were 8 recording channels used and with them was included a theatre-type reproducing amplifier and speaker system for monitoring purposes. Six of these channels were used to record the orchestra which was divided into 5 parts and each part grouped around its respective microphone. These sections of the orchestra were: Channel A, high-frequency strings (violins, etc.); Channel B, low-frequency strings (bass violins, etc.); Channel C, wood-winds (clarinets, etc.); Channel D, brasses (trumpets, etc.); and, Channel E, percussives (drums, etc.). The 6th or Channel F, consisted of a conventional microphone pick-up with the microphone located in the auditorium at a considerable distance from the orchestra. Channel G consisted of a close-mix having the 5 individual channels combined through a mixer panel. Channel H carried the cue or "rhythmical beat".

The block diagram is incomplete in that it does not show the duplication of the recording channels. Six inputs are shown for the mixer for the close-mix recording although only 1 is connected to any apparatus. The other 5 connect to the other 5 channels used in recording the various sections of the orchestra.

The mixer used for monitoring has 8 inputs, only 2 of which are shown connected. Of the remaining 6, one connects to the monitor amplifier of the conventional microphone pick-up channel and the other 5 connect to the respective monitor amplifiers of the 5 channels used in recording the other 5 sections of the orchestra.

A separate room in the basement of the Academy was installed for a monitoring booth for the Classical pick-up, that Channel which photographed the sound of the entire orchestra. It contained a monitoring loudspeaker and all acoustical material necessary for the correct balance of sound as picked-up by the microphone. The dials in this room were operated by a Disney sound engineer who was directed by a Disney staff musician similarly as were directed the mixers, to guard against overloading and under-modulation.

*In addition to this, an acetate machine cut records for immediate play-back to record the general performance of the orchestra for immediate study.*

On-stage as Stokowski directed the Philadelphia Orchestra sat 2 Disney musical technicians. To one, went the responsibility of establishing the *rhythmical beat*, recorded on a separate channel, to create a basis for laying out scenes in the actual work of charting, animating, and re-recording as to time and footage and re-orchestration. He operated a specially constructed beat machine, similar in operation and noise to a telegraphic key. While watching Stokowski's arms and synchronizing them with the sound

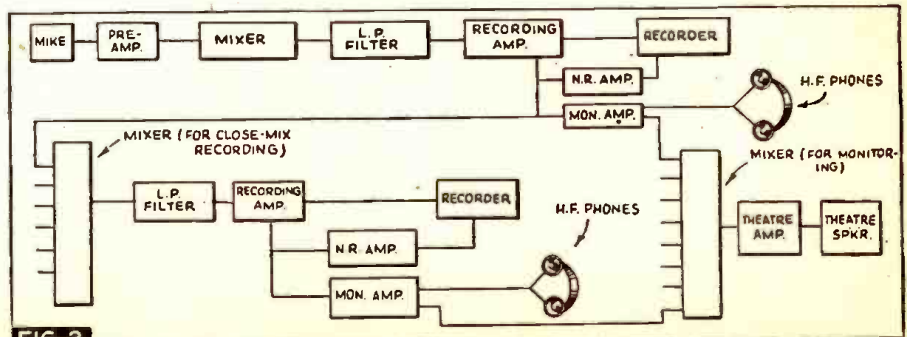

Fig. 2. Block diagram of the equipment set-up during the recording of sound for "Fantasia." This was the arrangement of the apparatus at the Academy of Music, in Philadelphia, Pa. Items L.P. are low-pass filters; N.R. Amp., noise-reduction amplifier; H.F. Phones, high-fidelity phones.

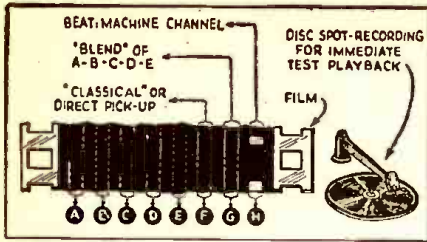

Fig. 3. This drawing prepared by Radio-Craft serves to illustrate the 8-channel sound-film recording made during the preparation of "Fantasia". Individual microphones picked up portions of the orchestra which were recorded as channels A to E, inclusive. Simultaneously these channels were electrically combined to create the special "blend" indicated as channel G; and, a separate microphone was used to afford simultaneous group pick-up of the orchestra for recording as channel F. Here are shown, exaggerated in timing for purpose of illustration, marker impulses, channel H, from the "beat machine," for subsequent synchronization of the action sequences with the accompanying sound.

of the orchestra, this technician tapped off the beats for the entire program.

The other Disney staff member sat beside the podium from which Stokowski directed, waiting for the signal from the basement below containing the recording machines and mixers when they were ready to photograph the sound. At a signal via the interphone he would nod to Stokowski who would cue him when the orchestra was ready to commence. Through the interphone the assistant director would shout, "roll them", then beat out the identifying symbols, call out the section to be played, the name of the musical selection and the punch marks to be applied by the recordists. All this cue data was reproduced on the sound track as a guide to the film cutters.

**SUMMARY**

The heading illustration showing Mickey Mouse is an artist's drawing from a photo by Walt Disney Productions representing about 2 frames of the picture film. Note however that a standard (unenanced-volume) sound track, not shown in this illustration, actually is included on the picture film! Ordinarily unused, in an emergency however it may be picked-up by a standard soundhead in the picture projector, and reproduced over a theatre's standard sound system. This sound track was specially recorded, in Hollywood, from the group of tracks originally recorded in Philadelphia.

Another item to note in connection with this sound setup, is that its primary purpose is not merely to demonstrate 3-dimension sound (only early portions of the picture emphasize this factor), but that enhanced sound (extended dynamic range) is featured.

"Fantasia" is built around the following musical masterpieces played by the 103-piece Philadelphia Orchestra:

- (1) Toccata and Fugue in D Minor Bach
  - (2) The Nutcracker Suite Tchaikovsky
  - (3) The Sorcerer's Apprentice Dukas
  - (4) Rite of Spring Stravinsky
- INTERMISSION
- (5) Pastoral (6th) Symphony Beethoven
  - (6) Dance of the Hours Ponchelli
  - (7) Night on Bald Mountain Moussorgsky

(8) Ave Maria Schubert

Briefly summarizing the 3 main advantages of the Fantasound system over a standard sound reproducing system we see: (1) 3 separate amplifier and loudspeaker channels which make the sound source move about on the stage and in the auditorium; (2) a tremendously increased volume range easily equivalent to that of a symphonic orchestra; and, (3) a greatly heightened illusion of reality achieved by spreading the sound around the stage and auditorium.

**COMPLETE RADIO COURSE \$1.95**

**How 8,749 Servicemen Obtained Their Training**

You may also get exact reprint of the regular \$39.00 Radio Technical Institute course for only \$1.95, the full price. This is the latest radio servicing course complete in every way and exactly the same as the much higher priced original lessons.

**WILL HELP YOU GET A RADIO JOB**

"I think your course is tops." Leonard D. Robinson, Toronto, Canada.

**FINE COURSE**

"I would like to say you have a very fine Radio Course." Wilford Sanders, Jr., Parrish, Ala. You can get started in Radio with a total investment of only \$1.95. This is the lowest priced radio training. Act today.

**GREAT HELP**

"I consider the course a most valuable addition to my radio library. Also, my diploma impresses my customers and, thereby, helps my business. I would not part with my course for any sum if I could not secure another. It is a gold mine of useful information." Frank Courtney, Augusta, Ga.

**RECOMMENDED FOR BEGINNERS AND EXPERTS**

"I would recommend your Radio Technical Institute course to any radio man." R. J. Heilman, Claremont, N. H.

**AMAZING REDUCED PRICE**

Repair all radio sets expertly, learn new speed-tricks of servicing, short-cuts, profit making ideas. Brush up on latest servicing methods. A single time-saving hint will more than pay for the special \$1.95 price for the complete course and all supplementary material. Make certain of your place in Radio. Learn to repair all radios quickly and properly.

**LIMITED OFFER**

Write to us today while this offer is in effect. Only a limited quantity of courses printed to sell at the reduced price.

**FOR HOME-STUDY**

Get ahead in Radio with this Practical training. The lessons are clear, interesting, easy to understand and use. Final exam and diploma available after course is finished. Look the course over without any risk.

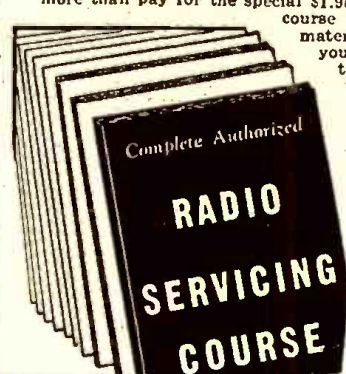

**10 DAYS FREE EXAMINATION**

**SUPREME PUBLICATIONS, Room 535**  
3727 W. 13th St., Chicago, Ill.

Ship the complete course on approval without any obligation to buy. I may keep the course for 10 days. If, for any reason, I am not pleased, you guarantee to refund my money.

I will give \$1.95 and 15c Postage to the postman.

I am sending \$1.95, the full price, ship postpaid.

Name: \_\_\_\_\_

Address: \_\_\_\_\_

The tremendous amount of research and study involved in developing this unique sound system, and the experience gained in its installation and testing, have opened up a complete new field on sound-on-film reproduction. It is believed that many of the advantages of this system soon can be made available to all theatres in a somewhat simplified form.

It is noteworthy that, aside from the special multi-track soundheads and variable gain amplifiers, all components of this special sound system are standard sound reproducing items provided with current theatre sound equipment. Thus, when the application of these special sound recording methods becomes more general, the sound equipments now installed in theatres will not become obsolete, but may be used as the main portion of a new enlarged system.

"Fantasound" is not to be restricted to Broadway, since 12 reproduction machines have been constructed by RCA for the road performances of "Fantasia" in the nation's 76 largest cities.

**FEATURE ARTICLES IN THE FEBRUARY RADIO & TELEVISION**

- Frequency Modulation for the Beginner . . . F. L. Sprayberry
- Thoughts on U.H.F. Receivers . . . S. Gordon Taylor
- "Compressed Dipoles" . . . E. G. Gardiner, B.Sc.
- Building a Small Oudin High-Frequency Coil . . . Herman Yellin, W2AJL
- High-Fidelity All-Wave Tuner . . . F. J. Gaffney
- A Precision Frequency Monitor . . . Larry LeKashman
- "CO" . . .
- Beam Antenna Hints . . .
- Battery-Operated Photo Cell Relay . . .
- 4-Tube de Luxe Regenerative Receiver . . . W. Ward
- A Good "Code Practice" Oscillator, and How to Use It . . . Wm. Hayes, W6MNU
- "Pull-Swing" Frequency Modulation—A Brand New System for Amateur Transmission and Reception (First Publication) . . . Ricardo Muniz, E.E., Donald Oestreicher and Warren Oestreicher

**DATAPRINTS**



**TESLA-LOUDIN COILS**

- 20c Ea. in order for 10 (Data and Drawings only.)
- 26" Sp'k Tesla-Oudin Coil 40c
- (1 K.W. Exc. Trf. Data incl.)
- 8" Sp'k Tesla-Oudin Coil 40c
- (1/2 K.W. Exc. Trf. Data incl.)
- 3" Sp'k Oudin; 110 Vt.
- "Kick Coil" type . . . . .40c
- 3" Tesla Works on Ford Coil . . . . .40c
- 1" Sp'k Vibrator Hi-Freq. Coil 40c

NEW! 5 ft. Sp'k. Oudin Coil & Exciter

Data . . . . .75c



**Induction PIPE & ORE LOCATOR**

Induction Type, Data . . . . .40c

Radio Type . . . . .40c

**More DATAPRINTS 40c each!**

- |                          |                         |
|--------------------------|-------------------------|
| 5 Meter Superhet.        | Electric Refrigerator   |
| 1/2 Meter Tr. & Rec.     | Wheatstone Bridge       |
| 20 A.C. Probs. & Ans.    | Weld. Transf. 2 K.W.    |
| 20 Telephone Hook-ups    | Rewinding Armatures     |
| 100 Mech. Movements      | String Galvanometer     |
| 20 Motor Hook-ups        | 20 Simple Bell Circuits |
| Television Hook-up       | Steel Wire Recorder!    |
| 20 Elec. Party Tricks    | Water Wheels            |
| Solenoids and Magnets    | Water Turbines          |
| —get list.               | Photo Cell and Relay    |
| Fry Eggs on Ice!         | Ring, 4 bells; 2 Wires  |
| Experimental Photophone  | 20 Tesla Tricks         |
| Radio Control for Models | Polarized Relay         |
| Diathermy Apparatus      | Induction Balance       |
| Inductor Organ           | Electric Pipe Thawer    |

Special Prices: 4 prints \$1.00; 10 for \$2.00; Single, 40c each. Get New Catalog 100 A.

**The DATAPRINT Co.**  
Lack Box 322D, Ramsey, N. J.

# THE FINEST RADIO BOOK WE EVER OFFERED

You receive Valuable subscription to **RADIO-CRAFT**  
PLUS A FREE COPY of 1940 Radio-Television Reference Annual

WITH our compliments, we want to send a copy of the 1940 RADIO-TELEVISION REFERENCE ANNUAL to you FREE, if you will simply take advantage of RADIO-CRAFT magazine's special subscription offer NOW. This offer is being made for a limited time only.

The 1940 RADIO-TELEVISION REFERENCE ANNUAL has 68 pages, large size 8½ x 11½, with over 170 illustrations. The contents of this book has never appeared before in handy book form. Its pages cover practically every branch of radio sound, public address, servicing, television, construction articles for advanced radio men and technicians, time and money-saving kinks, wrinkles, useful circuit information, "ham" transmitters and receivers, and a host of other data.

The Annuals have always been regarded as a standard reference work for every practical branch of radio operation and service. This 1940 edition ably sustains this reputation. Every radio man wants a copy of this valuable book. Just as this book will be of unquestionable value to you, so, too, will every monthly issue of RADIO-CRAFT. This magazine brings you big value every month. It keeps you intelligently informed about new developments in radio and television. You want the news, want it fully but concisely, want it first—that is why you should read RADIO-CRAFT regularly.

This very special offer is made for just one purpose—we want you as a regular subscriber. The Annual, whose contents appears at the right, is not sold, but a copy is FREE to you if you subscribe now.

**SAME SIZE AS  
RADIO-CRAFT**

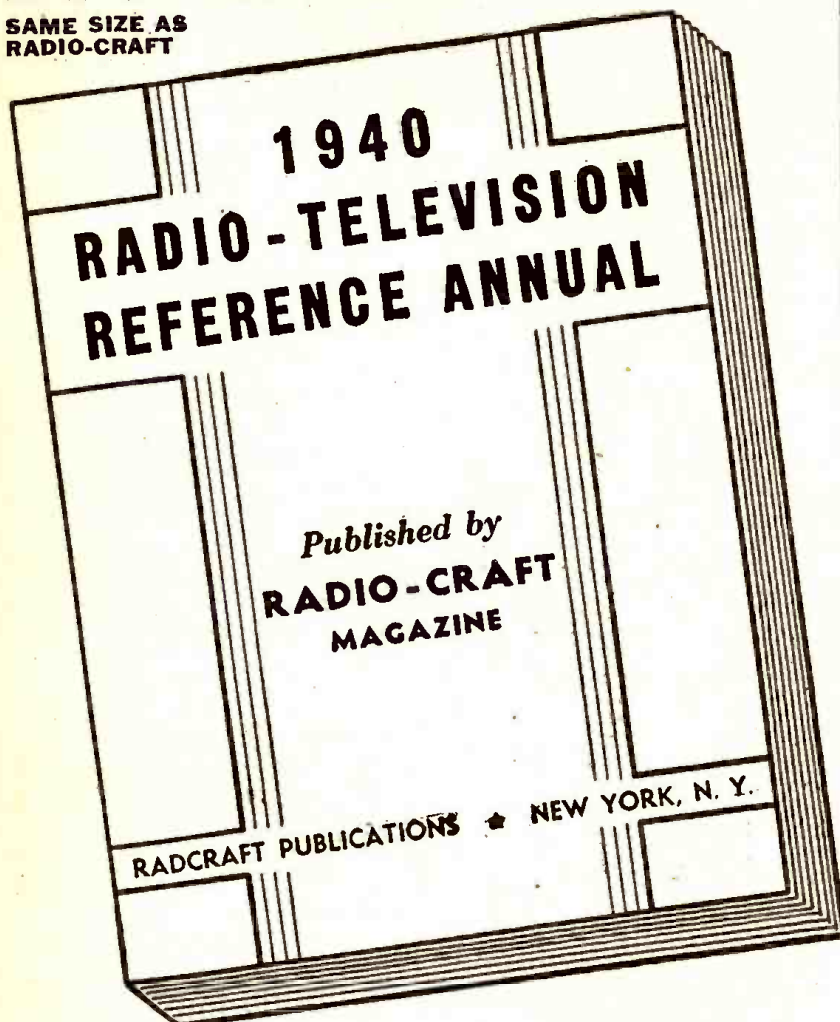

**THIS COUPON BRINGS YOU THE ANNUAL**

RADIO-CRAFT • 20 VESEY STREET • NEW YORK, N. Y.

Gentlemen: Enclosed you will find One Dollar for which enter my subscription to RADIO-CRAFT Magazine for Eight Months. Send me ABSOLUTELY FREE and POSTPAID, my copy of 1940 RADIO-TELEVISION REFERENCE ANNUAL.

This is a new order  Extend My Present Subscription

NAME ..... ADDRESS .....

CITY ..... STATE .....

DON'T DELAY — MAIL TODAY! RC-241

## Read the summary of contents in this FREE BOOK!

THE 1940 RADIO-TELEVISION REFERENCE ANNUAL contains a collection of the best and most important articles. Covering as they do nearly every branch of radio, they form a handy reference works. In addition, many time and labor-saving kinks, circuits and wrinkles, tried and tested by practicing Servicemen, experimenters and radio fans have been included. This book cannot be bought anywhere at any price. Yet it is yours by merely subscribing. Use the convenient coupon below.

### BEGINNER'S SIMPLE INEXPENSIVE CONSTRUCTION ARTICLES

Beginner's Breadboard Special • a 1-Tube High-Gain All-Wave Receiver—Wiring Pointers for Radio Beginners—A Watch Charm Size 1-Tube Set—Beginner's Simple Volt-Milliammeter—Making a 1-Tube Broadcast Loop Receiver—A.C.-D.C. Power Supply for Battery Portables—A 1-Tube Short-Waver with Band Coil Switching.

### MORE ADVANCED SET CONSTRUCTION

The "High-Seas 4" Broadcast Lamp Radio—How to Build a 6-Tube 1.4-Volt Short-Wave Superhet for the "Ham" or Short-Wave Fan—Build the "Lunch Box 5" Super Set—a Broadcast Battery Portable—How to Build a Plug-Together 8 Tube Broadcast Set—The "5-in-1" All-Wave Radio for A.C. Operation—An Easily-Built 3-Tube Midset Broadcast Superheterodyne Receiver.

### THE SERVICEMEN'S SECTION

Bass Tone Control—Simplified Variable Selectivity—Practical Servicing Pointers—Servicing Universal A.C.-D.C. Receivers—Killing the "Intermittent" Bug—A Service Shop A.C. to D.C. Power Supply—Sideline Money for Servicemen—Adding A.V.C. to any Screen-Grid T.R.F. Receiver—Iron Particles in Speaker Air Gap.

### TEST INSTRUMENTS

A Useful Neon Lamp Tester—An Inexpensive Output Meter—Making Milliammeter Multipliers—Home-Made Frequency Modulator—The Busy Servicemen's V.T. Volt-Meter.

### PUBLIC ADDRESS AND AMPLIFIERS

Build this Combination A.C.-D.C. Radio and Inter-Communicator—Speaker Placement in P.A. Work—The Design and Construction of an Inexpensive All-Push-Pull 10-Watt Amplifier—Obscure Sources of Hum in High-Gain Amplifiers—How to Build a High-Fidelity 5-Watt Versatile Amplifier.

### "HAM" SECTION

Ultra-High Frequency Antennas—The Beginner's Low-Cost Xmitter—Modulator Meter—Phone Monitor—The Beginner's "Ham" Receiver—2½ Meter Acorn Transceiver.

### TELEVISION

How to Build a 441 Line T.R.F. Television Receiver—Useful Notes on Television Antennas.

### MISCELLANEOUS

Simple Photo-Cell Relay Set Up—Making a Burglar Alarm—How to Build A.C.-D.C. Capacity Relay—How to Make a Modern Radio Treasure Locator.

### USEFUL KINKS, CIRCUITS AND WRINKLES

Making a Flexible Coupler—Two-Timing Chime—A Simple Portable Aerial—An Improvised Non-Slip Screw-Driver. NOTE: The book contains numerous other useful Kinks, Circuits and Wrinkles, not listed here.

(approximately)

**45 ARTICLES**

(approximately)

**170 ILLUSTRATIONS**

**68 BIG PAGES**

**RADIO-CRAFT**  
20 VESEY STREET  
NEW YORK, N. Y.

# SMALLEST RADIO TUBES!

Designed specifically for the hearing-aid trade, but also usable in experimental radio circuits, 2 new pentodes, here described, establish new minimum mechanical and electrical limits in the construction of small-space amplifiers. Experimental hearing-aid circuits incorporating these "world's smallest" tubes are given.

R. D. WASHBURNE

THE types HY245 and 255 tubes here illustrated and described are not only "the smallest pentode-type tubes that have ever been manufactured, but they furthermore require the lowest battery drain in both the filament and plate circuits of any tube yet developed", states the manufacturer, and continues, "in addition, the efficiency of the tubes is the greatest that has ever been achieved."

These super-tiny tubes smash all precedences in small-space types (\*), and without doubt are the smallest of any on the world market.

## CIRCUITS

Circuits A, B and C of Fig. 1 illustrate typical circuits in which only the 2 new

\*See "Peanut-size Tubes," Radio-Craft, Sept. '39, p. 186; also, "Radically New Miniature 'Button' Bottom Tubes," Feb. '40, p. 465; and, "1 Thumb-size Pentodes for Hearing-Aids," May '40, p. 682.

One of the new pentodes, here compared with a ladies' wrist watch, suggests that wrist-band radio sets may soon become practical. A plug-in octal base serves temporarily for testing and to identify the leads.

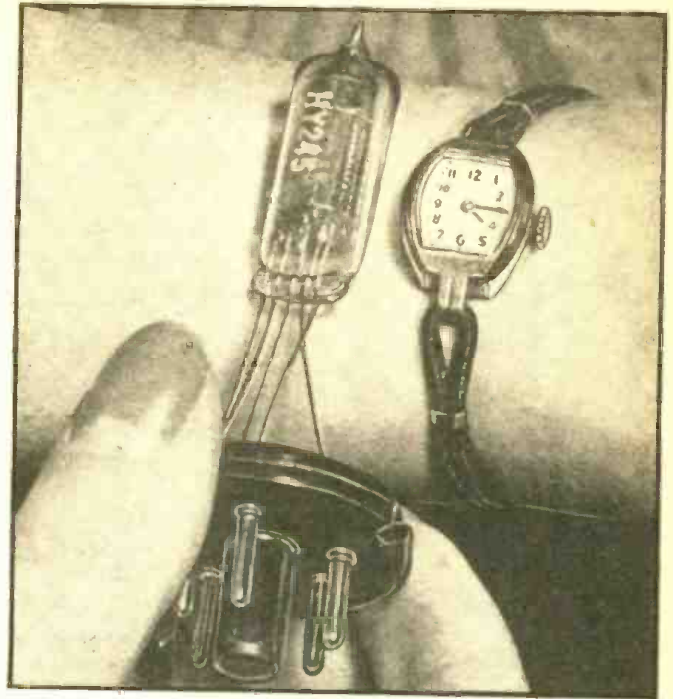

tube types are required for constructing high-gain audio amplifiers for use as hearing-aids, etc. Note that fairly wide variations in circuit constants are tolerable when these hearing-aid tubes are employed.

The tubes are available with 1½-inch leads for direct electrical connection into the circuit. An octal base is furnished, how-

ever, to facilitate checking of the tubes in test setups. If it is desired to keep track of the leads, after removing this base, they may be color-coded with enamel for identification.

These new Hytron tubes have approximately the plate load values indicated in the accompanying tables. However, for maximum gain and power output, the plate load should be adjusted to provide maximum circuit efficiency. Optional output circuits for use in this connection are shown in Fig. 2.

## SMALLEST SIZE

Actual comparisons of these super-Bantam tubes with the Bantam, Jr., type, smallest previously made by this manufacturer, are as follows:

The Bantam, Jr., tubes, without bases occupied a volume of 0.450-cu. in., and hearing-aid tubes in another make of small-space types, about 0.295-cu. in., whereas the new super-Bantam types have a volume of but 0.200-cu. in.

In diameter, the super-Bantam measures 0.453-in. as compared with 0.590-in. for the Jr., and 0.500-in. for the other make previously mentioned.

Add to these small dimensions new lower figures for filament and plate drain and the whole thing sums up to a definitely "world's smallest" tube series for which experimenters and laboratory technicians have long waited. The success of this series will depend to a considerable extent on the uniformity of these tubes, both initially and in service. This probably will be dependent in part on how widely these tubes are accepted.

Note that these super-Bantams probably have comparatively high interelectrode capacities, and hence, cannot be considered ideal for use at radio frequencies. In the A.F. service for which they were designed, however, they should prove perfectly satisfactory. The HY245 is the high-gain voltage amplifier which precedes the HY255 "high power sensitivity" output tube. Two of the latter in push-pull should make possible ample audio output for small-space devices designed to operate a loud-speaker in the minimum possible space.

These new pentodes make use of a V-type high-tensile-strength alloy filament to af-

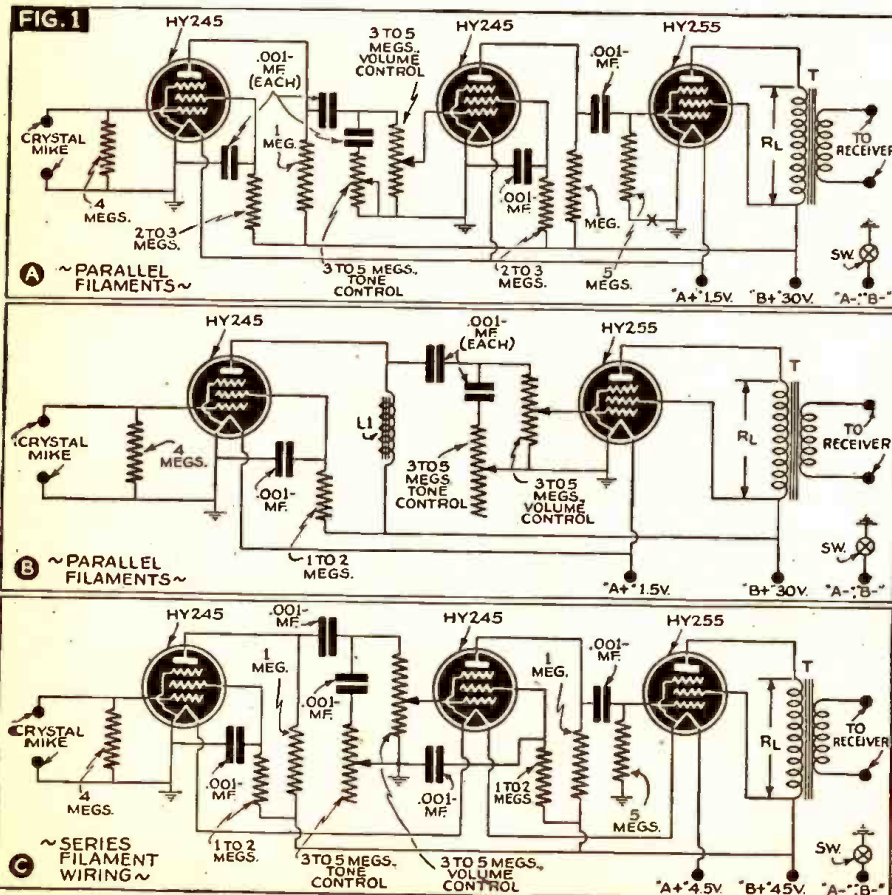

Fig. 1. Typical circuits for use with the new tiny pentodes, both series- and parallel-filament connections are shown in these audio-frequency amplifier circuits, which are especially suitable for use in hearing-aids. Output transformer T must be designed to match whatever earphone is selected. In Fig. 1, for 45 V. "B" operation, insert a 1.5 V. bias cell at X. In Fig. 2, choke Ch. measures 200 to 300 henries. In Figs. 1 and 2, R-L equals 50,000 ohms; in Fig. 3, 40,000 ohms.

## OPPORTUNITY AD-LETS

Advertisements in this section cost 15 cents a word for each insertion. Name, address and initials must be included at the above rate. Cash should accompany all classified advertisements unless placed by an accredited advertising agency. No advertisement for less than ten words accepted. Ten percent discount six issues, twenty percent for twelve issues. Objectionable or misleading advertisements not accepted. Advertisements for March, 1941, issue must reach us not later than January 8th.

Radio-Craft • 20 Vesey St. • New York, N. Y.

### A.C. GENERATORS

**110 VOLT A.C. AUTOMOBILE GENERATORS, EASILY installed.** Perfect performance. Operates ampliers, movies, etc. Lelaj Manufacturing, 152 Lelaj Building, Minneapolis, Minn.

### BOOKS AND MAGAZINES

**ASSURE YOURSELF OF GREATER PROFITS** by doing radio service jobs more quickly. Authentic service guides show you the way to locate and correct troubles in any radio receiver. Gernsback Official Radio Service Manuals show you how to complete more repair jobs in less time—how to earn more money by faster servicing. Radcraft Publications, 20 Vesey St., New York City.

**WE HAVE A FEW HUNDRED RADIO ENCYCLOPEDIAS**, by S. Gernsback, second edition, originally sold at \$3.98. Book has 352 pages, 1000 photos, size 9 x 12 inches. Rad more—karat flexible binding. Send \$2.49 in stamps, cash or money order and book will be forwarded express collect. Technifax, 1915 So. State Street, Chicago, Illinois.

**WHAT DO YOU KNOW ABOUT AMPLIFIERS AND SOUND SYSTEMS?** The Amplifier Handbook and Public Address Guide covers P.A. from A to Z. Most complete and authentic book published on the subject. Contains 80 pages of vital information on Amplifiers, P.A. Systems, Speakers, Accessories, Pickups, Microphones, etc. Printed on fine coated stock with numerous photographic illustrations and explanatory diagrams, and only 25c. See page 488.

### BUSINESS OPPORTUNITIES

**FOR SALE, IN NORTHERN W. VA. TOWN OF 25,000,** radio repair and sound equipment business. Owner in ill health; no reasonable offer refused. Write—Joseph B. Silverman, Phillips Clinic, Johns Hopkins Hospital, Baltimore, Md.

### DIATHERMY MACHINES

**FOR SALE—DIATHERMY MACHINE, CUSTOM-BUILT** by radio engineer. Machine substantially built with high patient safety factor, 250-300 watts output. Neat professional appearance. Automatic safety time switches. All necessary pads and electrodes, 16 meters. Cost \$350.00. Will sacrifice for \$150.00. Less than 1 year old. Will demonstrate. Write for appointment, J. FELDMAN, 566 W. 191st Street, Apt. 13, New York City.

### EDUCATIONAL COURSES

**USED CORRESPONDENCE COURSES AND EDUCATIONAL BOOKS** Bought, Sold or Rented. Catalog Free. Vernon Exchange, Henslar, Ala.

**CORRESPONDENCE COURSES AND EDUCATIONAL BOOKS**, slightly used. Sold, Rented, Exchanged. All subjects. Satisfaction guaranteed. Cash paid for used courses. Complete details and bargain catalog FREE. Write Nelson Company, 500 Sherman, Dept. B-242, Chicago.

### MANUSCRIPTS WANTED

**WANTED—MANUSCRIPTS, POEMS, SONGS** for publication. Fortuny's, 87 Fifth Ave., New York.

### PATENT ATTORNEYS

**INVENTORS—TAKE PROMPT STEPS TO PROTECT** your invention. Delays are dangerous. Get new FREE book, "How to Protect Your Invention," and "Invention Record" form. Preliminary information free. Reasonable fees. Conscientious counsel. Easy payment plan. Learn how to protect and sell your invention. Write us today. McMorro and Berman, Registered Patent Attorneys, 178-B Barrister Building, Washington, D. C.

### PHOTOGRAPHY

**1/100,000 OF A SECOND SPEED FLASH UNIT** for Stroboscopic Photography. \$200.00. Apt. 63, 782 West End Ave., New York City.

### RADIO

**WE BUY AND SELL USED RADIO TESTING EQUIPMENT.** Time payments if desired. Harold Davis, Inc., Jackson, Miss.

**CONDENSERS 1c UP, TUBES 10c. FREE LISTS.** Potter, 1314-C McGee, Kansas City, Mo.

**WANTED: ELECTROLYTIC DETECTOR, SLIDE-PLATE** variable condenser (preferably United), Magnavox model TRF-5 set, early studio-type carbon microphone in case, rotary spark gap and Thordarson "Flexible" transformer, Tuska "Superdyne," Adams-Morgan wooden case brass-plate condenser, "Cranit" loudspeaker. Will swap homo radio set, car-radio set, meters, etc. R. Bernard, 40 Manning Ave., No. Plainfield, N. J.

### TECHNICAL ART SERVICE

**DRAFTING AND ART SERVICE—A COMPLETE** Service for the Industrial and Commercial Marketers. If your business or plant can't afford a designer or drafting staff, don't let this stop you from going ahead with that new product you intend marketing, or that catalog of mechanical or electrical items which needs fine detailed drawings and highly retouched photographs. Any mechanical, electrical or radio problem can be solved for you by our associated staff of designers, draftsmen and artists, and technical copywriters. Write for any additional information as to methods and price for this service. Tec-Art Drafting Service, 228 Charlotte Terrace, Roselle Park, N. J.

**DRAFTING SCHEMATIC DIAGRAMS SEND US A** rough sketch of your circuit. Estimates by return mail. Our prices are moderate; our work guaranteed. No jobs too big or small. Wm. Kadocek, Jr., 410 East 85th St., New York, N. Y.

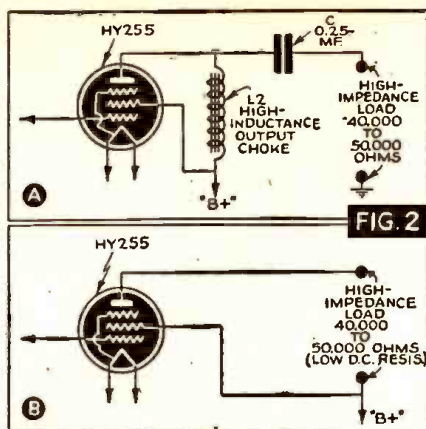

Fig. 2. Optional circuits. Circuit A is recommended for use with high-impedance crystal (or magnetic) receivers. Condenser C isolates the "B+" potential from the receiver circuit. Diagram B is for use only with low-impedance magnetic receivers.

ford maximum life and minimum microphonism.

### LOWEST "A" AND "B" DRAIN

Note that both these tubes have identical filament characteristics, i.e., 1.25 V. D.C. and 28 milliamperes, approx.

The 245 is designed to operate at zero grid bias; but a copper-oxide bias cell may be used to bias the control-grid of the HY255. Both tubes are designed for maximum operation at a plate voltage of only 45 V. The rated plate drain of the HY245 is under 1/2-ma.; the 255 draws about 1.1 ma.

The illustration of this tube in the photograph at the head of this article was posed by Radio-Craft and dynamically illustrates the tiny size of these new tubes. Their actual dimensions are given and illustrated in Fig. 3.

### CHARACTERISTICS

Provision must be made to prevent the filament voltage of either the HY245 or the HY255 exceeding 1.55 V. at the tube at all times. Less than 1 volt is not recommended.

For optimum conditions, 30 volts is recommended for plate and screen-grid supply as indicated in the tables.

The values indicated in the table, for the HY245's plate load, is an approximation based upon laboratory tests. It is suggested that the plate loading device be designed

| HY245                               |                               |                              |      |
|-------------------------------------|-------------------------------|------------------------------|------|
| TYPICAL AMPLIFIER OPERATION—CLASS A |                               |                              |      |
|                                     | Resistance - Capacity Coupled | Impedance - Capacity Coupled |      |
| Plate supply voltage                | 30.                           | 45.                          | 30.  |
| Screen-grid supply voltage          | 30.                           | 45.                          | 30.  |
| Control-grid bias                   | 0                             | 0                            | 0 V. |
| Plate load                          | 1                             | 1 meg.                       | 300  |
| Screen-grid dropping resis.         | 3                             | 2                            | 2    |
| Control-grid leak resis.            | 5                             | 5                            | 5    |

| HY255                               |        |        |                    |
|-------------------------------------|--------|--------|--------------------|
| TYPICAL AMPLIFIER OPERATION—CLASS A |        |        |                    |
|                                     |        |        |                    |
| Plate voltage                       | 30     | 45     | V.                 |
| Screen-grid voltage                 | 30     | 45     | V.                 |
| Control-grid bias                   | 0      | -1.5   | V.                 |
| Load impedance                      | 50,000 | 40,000 | ohms               |
| Control-grid leak resis.            | 5      | 5      | megs.              |
| Plate current                       | .85    | 1.1    | ma., approx.       |
| Screen-grid current                 | .2     | .35    | ma., approx.       |
| Power output                        | 10     | 18     | milliwatts approx. |
| Total harmonic distortion           | 15     | 12     | % approx.          |

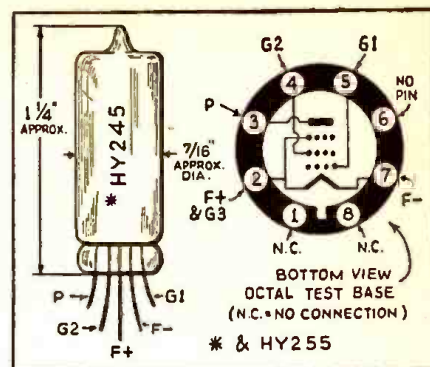

Fig. 3. Tube dimensions and connections. In this illustration, the new tiny pentode is shown in its actual size. Its connections are indicated with reference to an octal base. The types HY245 and '255 hearing-aid tubes are identical in appearance and terminal connections.

to obtain a minimum impedance of 1 meg. to obtain maximum voltage amplification. Impedance coupling affords high impedance at low IR drop across the plate load.

It is possible to operate the HY255 at zero grid bias where the values of plate and screen-grid voltage are 30 V. or less.

The values shown in the table, for the plate load impedance of the type HY255, is an approximation based on mean average laboratory measurements. It is recommended that the output loading choke be designed for a minimum inductance of 40 hy. at rated plate current. The reflected impedance of the receiver should not be less than 40,000 ohms to obtain maximum efficiency.

| HY245—Voltage-Amplifier Pentode |                    |
|---------------------------------|--------------------|
| STATIC CHARACTERISTICS          |                    |
| Filament voltage                | 1.25 V. D.C.       |
| Filament current                | 0.028 A. approx.   |
| Plate voltage                   | 45 V. max.         |
| Screen-grid voltage (G2)        | 45 V. max.         |
| Control-grid bias               | 0 V.               |
| Plate current                   | 0.4- ma. approx.   |
| Screen-grid current             | 0.2- ma. approx.   |
| Mutual conductance              | 375 umhos. approx. |
| Plate resistance                | 1.0 megs., approx. |

| HY255—Power-Output Pentode |                    |
|----------------------------|--------------------|
| STATIC CHARACTERISTICS     |                    |
| Filament voltage           | 1.25 V. D.C.       |
| Filament current           | .028 A. approx.    |
| Plate voltage              | 45 V. max.         |
| Screen-grid voltage (G2)   | 45 V. max.         |
| Control-grid bias          | -1.5 V.            |
| Plate current              | 1.1 ma. approx.    |
| Screen-grid current        | .35 ma., approx.   |
| Mutual conductance         | 460 umhos. approx. |

## OPERATING NOTES

... CROSLLEY (models using 10,000-ohm Speaker Field)

When the field coil burns out on one of these sets, an 8-in. P.M. dynamic speaker, which can be purchased at a cost comparable to that of the replacement field coil, may be used to replace the original speaker. Mount

the replacement on a fibreboard baffle, which may be installed in the set with the original hardware. Connect a 10,000-ohm, 25-watt resistor across the field coil terminals, at the speaker. The repaired set will have the tone quality of a new radio.

THOMAS PREWITT,  
Plainfield, Ind.

*Servicemen!—Install Them for Greater Profits*

# "ELECTRIC EYE" BURGLAR ALARMS

*The author tells how the use of photoelectric equipment for industrial applications is a "natural" for the radio Serviceman. A practical application which Servicemen should find to be a money-maker is described, and the necessary construction details are supplied.*

L. M. DEZETTEL

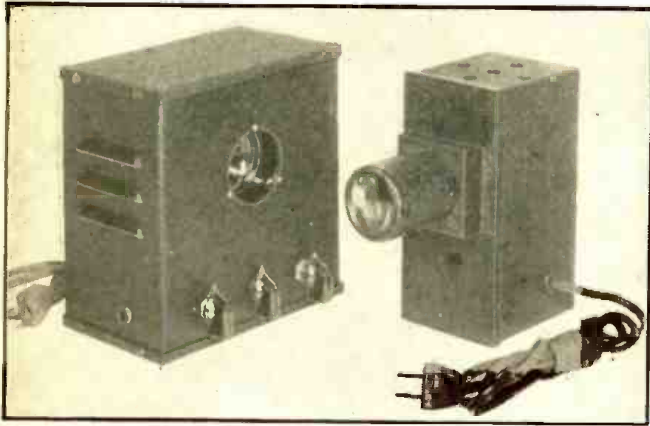

A commercial type of photocell equipment suitable for use in electronic burglar alarm systems. Left, photocell equipment in its housing; right, the exciter (light source). Photos—Worner Products Co.

**T**HE progressive radio Serviceman and dealer is constantly seeking additional products to merchandise. Knocking at his door is a comparatively unexplored market. This new market is the use of photoelectric equipment in industrial applications.

This type of equipment, operating upon the electronic principle, is in theory not unlike the operation of radio receivers or amplifiers. It is a "natural" for the radio Serviceman, who should find it easy to understand the principles of operation.

By far the greatest application of photoelectric cell equipment is its use in burglar alarm systems. In this application the scheme essentially comprises a beam of invisible infra-red light whose continuity from light-sensitive cell to alarm relay must remain unbroken if the alarm is not to be given. When this invisible barrier is broken by an intruder, electrical apparatus is set into motion to give an audible or visible alarm in any chosen place continuously until reset. This beam should be invisible even in the dark, thus giving ample protection to the property which is covered by the device.

## "BLACK LIGHT"

Let us consider the essential equipment in greater detail. A light source of the proper type is first required. Usually this takes the form of a low-voltage incandescent bulb of the automobile headlight type. The low voltage may be obtained from an A.C. source by means of a step-down transformer of the type carried by all radio supply houses. It should have a 6.3-volt output and sufficient carrying capacity for whatever type lamp you may use. An A.C.-D.C. type of light source merely is a small 115-V. projection lamp.

In an opening in the side of a light-tight box is a lens whose focal length is equal to the distance from the bulb to the mounting position of the lens. This will produce a nearly parallel beam of light. In back of this lens is placed a filter designed to absorb all light wavelengths below 7,200 Au. (Angstroms), allowing only infra-red or "black" light to pass.

The light source is placed so that the beam of light will pass by doors, windows and other points whose protection is required. For full protection around corners, mirrors are used. The sketch indicates the protection that may be obtained by the proper placement of mirrors. Obviously each installation requires ingenuity of thought, depending upon the circumstances.

## "ELECTRIC EYE"

At the other end of the beam is a photocell relay unit, also housed in a light-tight box, and with the lens mounted in an opening on one side. The purpose of this lens is to concentrate the beam of light on to the "electric eye" itself, excluding all other light.

The photocell relay unit contains a caesium-coated photocell, a vacuum-tube grid-controlled rectifier with appropriate resistors and condensers, and the relay. The operation of the photocell unit is explained later on. In its simplest form the switching part of the relay is connected in series with

2 or 3 drycells and a bell which may be mounted anywhere.

The light beam on the photocell maintains the relay in an open position; and when the beam is interrupted, the relay contacts close, ringing the bell. In actual application, however, a drop-out type of relay is used so that when the beam of light is interrupted, the bell continues to ring even though the intruder may step out of the beam of light.

Additional features are also incorporated which protect the user against power failure, prevent outsiders from tampering with the equipment, and allow other equipment to be added, such as an external alarm system.

## CONTROL BOX

Where complete protection is required and large areas are to be covered, there are systems which incorporate a special control box. To the control box may be connected one or several photocell systems, almost any amount of external alarm systems and other indicators; and, also, the closed-circuit type of burglar alarm protection.

You have probably seen many store windows with strips of tin-foil applied all around the glass and about 6 inches from the edge. This is part of a "closed-circuit system." The tin-foil strips are connected in series, and included in the circuit are switches on the doors, windows, etc., which open up when the doors or windows are opened. The circuit is then wired in series with a battery source and a high-resistance relay, and actuates an alarm when the circuit is broken. A high-resistance, sensitive relay drains very little current, and battery life is quite high.

## INSTALLATION

Actual installation is much simpler than you would imagine. The only consideration required is that the beam of light should protect entrances to the building and other

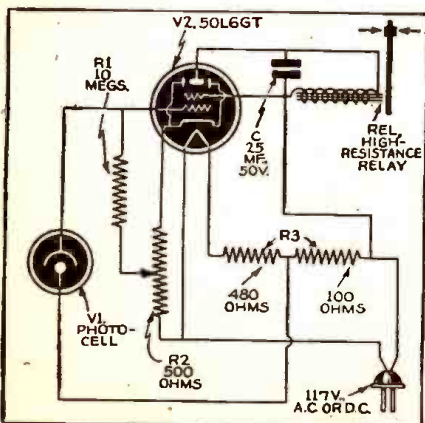

Schematic diagram of photocell-operated vacuum-tube relay. This is a simple A.C.-D.C. circuit which may be used for experimenting.

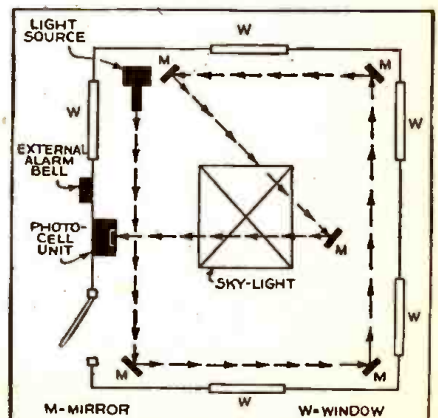

Plan of a photoelectric installation, requiring a number of mirrors but only one light source (exciter) and photocell unit, in a burglar alarm system.

# SUPER SPECIALS

All of the attractive items listed here are brand new. ALL are in PERFECT WORKING ORDER. In many cases, the parts alone total more than the price we are asking. 100% satisfaction guaranteed or your money refunded. ORDER FROM THIS PAGE. Use the convenient coupon below. Include sufficient extra remittance for parcel post charges, else order shipped express, collect. Any excess will be refunded. C.O.D. shipments require 20% deposit. If full remittance accompanies order, deduct 2% discount. Send money order, certified check, new U. S. stamps. No C.O.D. to foreign countries.

**ORDER TODAY LIMITED QUANTITIES PROMPT SHIPMENTS ASSURED**

## 2-SPEED PHONOGRAPH TURNTABLE



Adapts any phonograph for both 33-1/3 and 78 R.P.M. This ingenious device, by simply replacing your present turntable, automatically modernizes your machine to play 33-1/3 R.P.M. high-fidelity transcription records as well as the standard 78 R.P.M. records. Quickly installed by anyone. Complete instructions furnished. Felt-covered turntable measures 12" in diameter and fits all standard phonographs. Packed in original box. Original price \$3. Snp. Wt. 3 lbs.

ITEM NO. 89 YOUR PRICE **\$3.95**

## 2-WAY LAMP

Ornamental dual purpose lamp. Can be used as a table or vanity lamp in one position. By turning swivel base it becomes a bracket lamp which may be mounted on wall.

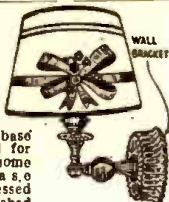

Hanger in base is provided for this. Handsome design. Base made of pressed glass, polished wood and plated metal stand. Comes with round shade colorfully decorated with ribbon design, or more elaborate fluted shade with flower design. Height of lamp 12 1/2"; shade 8". Complete with cord. Shipping wt. 2 lbs.

ITEM (Plain Shade) NO. 120 98c  
ITEM (Fluted Shade) NO. 121. YOUR PRICE **\$1.05**

## BENNETT LABORATORY BALANCE

A compact laboratory balance made of finest quality tested materials. Extreme sensitivity (to 2-100ths gram or 2-7ths grain). Weighs to one decimal pt. further

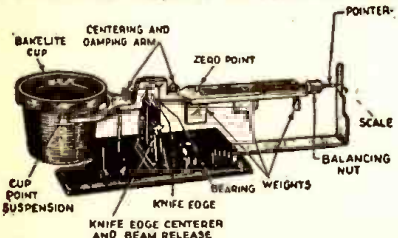

than usual low priced counter scale. Will handle up to 100 grams (about 4 oz.). Bakelite pan; tool steel knife edge; sapphire bearing for long life and accuracy. Ideal for photographic work and lab use. Handsome streamline design. Graduated either in metric or apothecary system. Shipping wt. 2 lbs.

ITEM NO. 122 YOUR PRICE **\$7.20**

## 100 POWER TELESCOPE LENS KIT



Make your own high powered 6 ft. telescope! Now you can thrill to a close-up view of the worlds out in space. See the rings around Saturn, the mountains of the moon! Kit contains 3" diam., 75" focal length, ground and polished objective lens and 2 astronomical eye-pieces, magnification 50x and 100x. Complete kit with full instructions.

ITEM NO. 123 YOUR PRICE **\$1.95**

## New Catalog

**JUST OUT**  
A POSTAL CARD BRINGS IT TO YOU  
SEND FOR IT TODAY

**HUDSON SPECIALTIES CO., 40 West Broadway, N. Y. C.**

IT'S EASY TO ORDER—CLIP COUPON—MAIL NOW ORDER FROM THIS PAGE.

HUDSON SPECIALTIES CO., 40 West Broadway, Dept. RC-241, New York, N. Y.  
I have circled below the numbers of the items I'm ordering. My full remittance of \$..... (Include shipping charges) is enclosed.  
OR my deposit of \$..... is enclosed (20% required), ship order C.O.D. for balance. No C.O.D. order for less than \$2.00. (New U. S. stamps, check or money order accepted.)  
Circle Item No. wanted: 86, 87, 89, 97, 120, 121, 122, 123, 124, 125

Name ..... Address .....

City ..... State .....

Send remittance by check, stamps or money order; register letter if you send cash or stamps.

## AMAZING BLACK LIGHT!!



Powerful 300-Watt Ultra-Violet Bulb  
The best and most practical source of ultra-violet light for general experimental and entertainment use. Makes all fluorescent substances brilliantly luminescent. No transformers of any kind needed. Fits any standard lamp socket. Made with special filter glass permitting only ultra-violet rays to come through. Brings out beautiful opalescent hues in various types of materials. Swell for amateur parties, plays, etc. to obtain unique lighting effects. Bulb only. Size of bulb.

Snp. Wt. 1 lb.  
ITEM NO. 87 YOUR PRICE **\$2.00**

## ULTRA MAGNET

LIFTS MORE THAN 20 TIMES ITS OWN WEIGHT

LITTLE GIANT MAGNET. Lifts 5 lbs. easily. Weighs 4 oz. Made of ALNICO new high-magnetic steel. Complete with keeper. World's most powerful magnet ever made. The experimenter and hobbyist will find hundreds of excellent uses for this high quality permanent magnet. Measures 1 1/4" x 1 1/4". Snp. Wt. 3/4 lbs.



ITEM NO. 86 YOUR PRICE **\$1.00**

## ELECTRIC TURNTABLE



A sturdy electric turntable. Ideal for eye-catching window displays. A MUST for alert retailers. Frame made of 16 gauge steel. 16 in. steel turntable makes three revolutions per minute. Turntable supports load of 200 lbs. Ballbearing construction. Rich black enamel finish. Operates on 110 v. A.C. Current cost only 1/2 a day. Size: 5 1/4" high, base 8" square. Shipping wt. 14 lbs.

ITEM NO. 124 YOUR PRICE **\$8.95**

## NEW ELECTRIC MOTOR-SAW

Now you can have all the fun of fine, fast jig saw work without any of its difficulty. Simply steer the lightning-fast blade and see it seemingly melt its magic way through wood, plastics and building board. 7200 STROKES per MINUTE! Average cutting speed 1 foot per minute through 3/4" medium hard wood. Works 3 times faster than any hand saw. Operates on 50-60 cycle 110 v. Alternating Current. Screw adjusts blade stroke from 1/4" to 5/16". Off-On Switch built in handle. Complete with 8 ft. power cord and 3 saw blades.

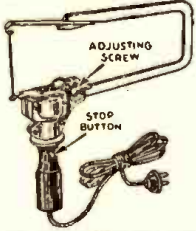

ITEM NO. 87 YOUR PRICE **\$4.85**

## ELECTRIC HUMIDIFIER FOUNTAIN



Adds healthful moisture to the air in winter. Evaporates as much as a pint of water in 24 hours. Fountain is 14" in diam. Sprays 8 streams of water 5" above fountain head. Made of spun aluminum. Comes in two colors: Bronze, chrome, copper, red, green. No water connections required. Just plug into 110 volt. 60 cycle A.C. outlet. Current consumption few cents a month. Complete with base switch and 8 ft. power cord. Shipping wt. 9 lbs. List price \$14.95. Only a limited supply on hand.

ITEM NO. 125 YOUR PRICE **\$4.95**

areas. It is not important just how the light source is mounted; a small shelf built into the corner of the room but rigidly mounted, about 4 feet above the floor, is a good place from which to start.

Mirrors can be mounted on the walls or on pillars. The photocell relay unit may be mounted on a shelf similar to the light source. One important thing to keep in mind is that the adjustment of the mirrors must be such that the beam of light will pass from one to another without any appreciable loss of light. The greater the intensity of the light that finally reaches the photocell unit, the more reliable will be the operation.

Keep the distance between the light source and the photocell unit within the limits specified by the manufacturer. This is usually between 75 and 125 ft. Systems will work over greater distances, but the intensity of the light beam must be increased, and careful protection against the entrance of extraneous light onto the photocell is required.

## THEORY; OTHER APPLICATIONS

The theory behind the operation of the photocell unit is not at all difficult to understand. Referring to the schematic diagram, you will notice that the grid of the tube is operated at a greater negative potential than the cathode. The proper operating point is obtained by the adjustment of a potentiometer and is usually just about cut-off voltage for the tube. The Caesium-coated photocells have the fortunate property of producing effects similar to a resistor, —varying in resistance in direct proportion to the amount of light falling on the cathode. As you will notice, the photocell is connected from the control-grid to a point on the line where it obtains a certain amount of D.C. potential. As light falls on the cell, its resistance is lowered from an almost infinite resistance (at no light) to a much lower value so that the grid of the tube becomes more positive with respect to cathode. This causes current to flow in the plate circuit of the tube, thus actuating the relay.

If, as in burglar alarm systems, the beam of light remains on the photocell, the plate current will flow continuously, holding the relay in. As the relay used is of the double-throw type, connections are made to the "normally closed" contact. When the beam of light is interrupted, the control-grid of the tube regains its negative bias, cutting off the current in the plate circuit of the tube, and allowing the relay to drop closed.

Equipment of this type is also being used regularly in smoke control, sorting, counting, humidity control, lighting control, annunciator systems, oil burner control, and a host of other applications.

## LIST OF PARTS

- One G.M. Laboratories photocell, type 59-Z, V1;
- One IRC resistor type BT 1/2, 10 meg., 1/2-watt carbon, R1;
- One IRC resistor type W500, 500-ohm potentiometer, R2;
- One Ohmite resistor No. 0570, 750 ohms, 50-watt divider (with extra slider; adjust sliders for 480 ohms and 100 ohms), R3;
- One Amphenol "Mip" octal socket;
- One Amphenol "Mip" 4-contact socket;
- One Aerovox condenser, type PRS, 25 mf., 50-volt electrolytic, C;
- One Allied relay, type PC, 2,500 ohms, S.P.D.T., REL.;
- One RCA tube, type 50L6GT, V2.

This article has been prepared from data supplied by courtesy of Allied Radio Corp.



## INTRODUCING "SOUNDIES"

*Dime motion pictures in bars, highway stands, hotel lobbies, etc., made possible by a new coin machine, add another new avenue of revenue for sound specialists and radio Servicemen.*

IN back of that vertical-bar grill-work you see underneath the picture screen in the dime-movie machine at upper-right, which Capt. James Roosevelt is so intently observing, are 4 loudspeakers. These constitute part of the sound system devised for this 16-mm. apparatus by RCA. The remaining equipment are the amplifier and its power supply, but mention of the loudspeaker complement should be the tip-off to technicians that in the installation and service of this machine (and competitive counterparts which may soon appear), lie many dollars. Like any talking motion picture, this apparatus requires the attention of experts to maintain proper operation of the equipment, from photocell to loudspeakers.

But let us get on with the rest of the story.

A *Soundie* is a strip of sound-on-film, 16 mm. in size, which plays on the *Panoram* machine for about 3 minutes. Eight of these soundies (made under the direction of James Roosevelt's Globe Productions, Inc.) make up 1 reel and consist of approx. 1,000 feet of film. Patron places one or more dimes in the coin chute and the proper number of soundies, each about 3 minutes in length, automatically play. The reel has no beginning, middle, or end. When one soundie is finished, the next one is ready to play. There is no rewinding at any time—no waiting. The soundie must get itself over to the public in 3 minutes, instead of an hour or two.

The *panoram* is a coin machine. It operates automatically upon the insertion of a dime, in a split second it goes into action. No attendant is necessary to start it, stop it or see that nothing goes wrong. After the patron drops his dime, he has nothing more to do but view the soundies.

The machine is entirely self-contained—projector, speakers, screen are all in one cabinet about 6 ft. high, 3 ft. wide and a little over 2 ft. deep. It's all done with mirrors—the light beam projecting the image is zigzagged inside the cabinet and comes out on a translucent screen. Thirty, 50, or even more people, can see the movie at one and the same time. The screen is 2x1.5 ft. high. Daylight doesn't bother it and it will show a clear image with electric lights turned on all over the room. It's made of unbreakable plastic.

Each soundie is a complete short in itself requiring a separate script, cast, director and recording. Eight to 10 soundies are on a single endless reel. Patron cannot select; he has to take the next soundie coming up. A moving program at top of machine informs him of sequence of the pictures.

About one new reel a week—400 to 500 separate subjects—will be needed each year. Films are rented to the operators of the machines at a rental of from \$10 to \$15 per week per reel. (Cost of the *panoram* movie machine is in the vicinity of \$1,000.)

Cooperating with Mills Novelty Company



James Roosevelt views his new "Soundies".

in the manufacture of the machines is RCA Mfg. Co. which records the soundies and manufactures the speakers and projectors for the *panoram*. Westinghouse has developed the new exciter lamps which burn a month instead of a week as former lamps did.

Cigar smokers in hotel lobbies, cocktail sippers in the better lounges, truck drivers devouring hamburgers at highway stands probably will have seen this new device in action by the time this issue of *Radio-Craft* reaches the newsstands. Big-name singers, musicians, entertainers, and a whole raft of promising newcomers will be seen and heard via the *panoram*.



I. E. Mourontseff inspects the newest "Klystron".

TO show how power may be beamed through air by a new "Klystron", each of 100 deans and professors, in the Westinghouse conference auditorium at the Lamp Laboratories in Bloomfield, N. J., last month, held aloft a flashlight bulb to which was attached a short wire antenna. As the "Klystron" poured forth its energy waves, which were focused through space like a beam of light with the help of a six foot horn, the bulbs became lighted as though connected to storage batteries.

The new generator has a variety of possible uses. It may be employed to increase greatly the number of television transmis-

## THE "KLYSTRON" TUBE

*Does It Herald Radio Transmission of Power?*

*This article describes the "Klystron," which engineers believe is the forerunner of devices which may some day make it possible for homes to be lighted with power picked from the air, as we now receive radio programs.*

sion channels; or the number of messages transmitted simultaneously over a telephone wire. It has potential value in producing heat for medical purposes by ultra short-wave. Another logical use is as an improved means for aircraft navigation. Homes might even be illuminated some day by power picked up from the air as we now pick up radio programs. The list of possible uses seems limited only by imagination, and by the instrument's relative efficiency as compared with existing methods of transmitting electric power.

The device, which originated about 2 years ago in the laboratories at Stanford University, a few months ago moved into the research laboratories of the Westinghouse Company at Bloomfield and East Pittsburgh, by arrangement with the Sperry Gyroscope Company, designated by the University to promote practical and commercial use of the new instrument.

### "POPULAR" DESCRIPTION

Westinghouse research engineers have succeeded in reducing the klystron's size and converting it into a vacuum-type tube without decreasing the output. It is a practical

device for obtaining power at high frequencies which has not been previously available. So complicated is the interior mechanism and structure that much time had to be used for proper methods of assembling and evacuating the tube, it was explained. I. E. Mourontseff and G. M. Dinnick, who among other engineers of the company have worked on the device, believe they have created the first practicable evacuated klystron. The new tube is also air-cooled instead of water-cooled, another important refinement and step forward. I. E. Mourontseff is shown in the accompanying photo making adjustments in the klystron.

The klystron sends out beams of power by breaking up an electron stream, bunching the individual electrons, and converting their energy into ultra high-frequency oscillations which are 10 times shorter than the shortest radio wave now in use. It does this by means of 2 small doughnut-shaped copper tanks called "Rhumbatrons", developed by William W. Hansen, a Stanford University physicist.

Professor Hansen was attempting to develop a new kind of "atom-smasher" when he devised this new method of making radio

# RADIO DEVELOPMENTS

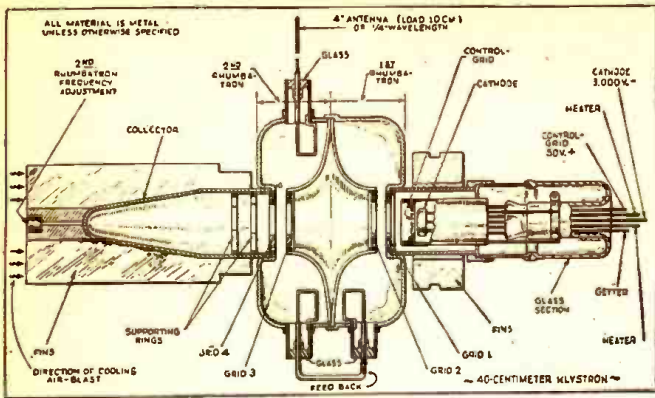

Cross-section of the 40-centimeter Klystron. The Klystron is composed of 2 Rhumbatrons. The 1st Rhumbatron "bunches" the electrons and passes them to the 2nd Rhumbatron, the "catcher," which transforms the electrons into radio energy at ultra-high frequencies.

waves surge back and forth within a metal tank, thus increasing the intensity of their oscillations. His colleagues dubbed the tank a Rhumbatron because of the rhythmic surging of the radio waves within its walls.

## TECHNICAL DESCRIPTION

The klystron takes advantage of the fact that the speed of electrons can be influenced by an electric field. As electrons race from an electrode at one end of the device, traveling in a continuous stream with a speed of approximately 20,000 miles a second under the impetus of 1,000 to 5,000 volts, they are

affected by the electric field oscillating in the first rhumbatron.

When excited electrically, the rhumbatrons or resonators produce rapidly-varying differences in voltages. It is these variations in voltage which cause the electrons in the beam to be grouped or bunched.

As the electrons pass between the bars of a grid (a screen-like opening) in the first rhumbatron, 3 things happen: some of the electrons are speeded up by the oscillating electric field; some are slowed down; and others are unaffected and just keep going at their normal pace. The effect on the electrons depends on whether the field is in the direction of electron motion or in the opposite direction.

Surging into a "drift space", the faster electrons of one group in the continuous electron beam overtake the slower electrons in the preceding group and form bunches of electrons. These bunches pass through the first grid in the second rhumbatron located at a point of strong concentration of electrons. Incidentally, the first rhumbatron is termed the "buncher" and the second is the "catcher". At the catcher, the energy of the electrons is transformed into electric oscillations vibrating hundreds of millions of times a second.

By means of a precise synchronization of the "buncher" and the "catcher" the electron groups are timed to go against an alternating current field within the "catcher", where they lose their energy of motion which is converted into high-frequency electrical energy. The high degree of charge concentration in the bunches corresponds to a correspondingly high value of electron current. In this manner, a beam of electrons

is converted into an impulse current—in effect, an alternating current superimposed on a direct current.

While "a coupling loop" feeds some of this oscillating energy back into the "buncher", another loop of wire carries part of the energy to a finger-length antenna on the outside of the "catcher", from which the high-frequency power is radiated.

The present klystrons are capable of producing electrical waves varying in frequency from some 750,000,000 to 3,000,000,000 cycles a second (750 to 3,000 mc.) and a wavelength of 16 to 4 inches, compared with ordinary shortwave frequencies of around 15,000,000 cycles (15 mc.) and wavelengths of from 300 to 10 yards. And even today, the klystron is able to broadcast its high-frequency waves with a power of 200 to 500 watts, comparable with the power of many commercial longwave radio transmitters.

## EXPERIMENTS

These short waves are great mimics; they travel very much like light waves and even somewhat like sound waves. Like light, they pursue a line-of-sight course. A striking experiment shows how the klystron waves differ from ordinary radio waves, which spread out and pass through non-metallic materials. While holding a glowing lamp in the klystron beam, a slab of wood between the lamp and the klystron's antenna will put the lamp out.

The manner in which the ultra-high-frequency waves follow a restricted level of motion—their so-called polarization—can be demonstrated by a long tubular fluorescent lamp. When the lamp is held at an angle to the klystron's antenna nothing happens, but when it is held parallel to the antenna, it glows, because in this position the lamp intercepts the maximum amount of waves which are traveling parallel to the antenna.

Another attribute of the new waves is their peculiar obligingness; they actually appear to stand still so that they can be physically measured. Connecting the klystron's antenna to 2 long, parallel wires, a filament lamp may be slid along the wires until it glows brightly. As the lamp continues to move along the wire, it loses its glow, but later regains it. The distance between the 2 bright spots is the distance between 2 crests of a klystron wave, and by multiplying this distance by two, the investigator obtains the length of an individual wave.

For the nominal amount of 35c we will send you the following values:  
 1. One duo-tone imperishably etched Bronze Name Plate, size 3x1 1/2 inches with your Social Security number and name permanently stamped upon it.  
 2. One Genuine Leather Billfold, size 8 1/2 x 3 inches in natural brown color, with four compartments, as per illustration above.  
 This Pocketbook is our free present to you. Absolutely no strings of any kind. We make you this gift because we expect you to do us a favor by showing your name plate to your friends, to interest them in ordering one for themselves. That's all. Help us and you will profit yourself.

**ACT NOW!** Mail the coupon below and enclose 35c in coins. This bronze name plate and the Leather Billfold will be forwarded to you at once.

### PREMIUM DISTRIBUTING SERVICE

Wrigley Bldg., Chicago, Dept. RC-241  
 Enclosed find 35c for which mail to the address below, my Social Security Bronze Plate and the Genuine Leather Billfold without extra cost, as per your offer.

My Social Security Number is .....

NAME .....

ADDRESS .....

CITY ..... STATE .....

## RADIO AIDS TRANSCONTINENTAL AIRWAYS

THE 20th Anniversary of the first coast-to-coast airway has just been celebrated, marking 2 decades of achievement on the important New York to San Francisco air transport route. In these 20 years of commercial air flying radio has become an indispensable adjunct in maintaining peak performance on the air lanes.

Before the 20th Anniversary year is ended, schedules will have been reduced—from the 63 hours of 10 years ago to 13 1/2 hours—with the introduction of 4-engined Super Mainliners. United Air Lines has ordered 20 of these big craft for delivery early in 1941. They will cruise at 228 miles an hour, carry 40 passengers and a crew of 5, transporting 10,700 pounds of mail, express and baggage.

Twenty years ago weather service in aviation was just a case of each individual pilot's judgment. Today every plane is in constant touch with the ground radio stations and is informed of the weather all along the route.

The ground radio stations are the heart

of commercial aviation. The operators at these stations are constantly in touch with the pilots in the air and with the other stations.



A United Airlines radio station with Kellogg equipment. Operators are in constant, 2-way communication with pilots in the air as shown here.

## NEW POWER PLUGS

Howard B. Jones  
2300 Wabansia Ave., Chicago, Ill.

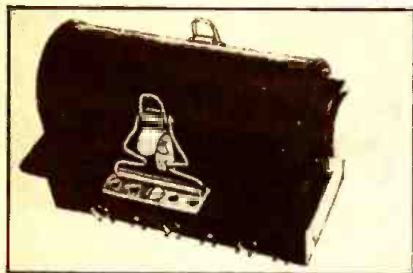

A NEW line of power plugs and sockets designed for 5,000 volts and 25 amperes. They are made in 2, 4, 6, 8, 10 and 12 contacts. All sizes are polarized to eliminate errors in making connections. All units are designed to prevent accidental contact with the fingers.—Radio-Craft

## STROBOSCOPIC RECORDING DISC

H. & A. Selmer, Inc.  
Elkhart, Indiana



A METAL-BASE, acetate-coated, blank recording disc which has a patented stroboscopic label which gives an instantaneous check on the turntable speed each time the record is played. The label permits the speed to be checked at 78 r.p.m. under a 60-cycle light. Available in 6 in. and 10 in. sizes.—Radio-Craft

## CODE-PRACTICE OSCILLATORS

Bud Radio, Inc.  
5205 Cedar Ave., Cleveland, Ohio



MODEL CPO-122 is an ear-phone-type code-practice oscillator which can handle up to 20 pairs of earphones or up to 5 small magnetic speakers. A variable tone control and pitch control permits both volume and tone to be adjusted to suit individual needs. Other types of code-practice oscillators are also available.—Radio-Craft

## PORTABLE ELECTRIC DRILL AND GRINDER

Paramount Products Co.  
545 5th Ave., N. Y. C.

ALTHOUGH small in size and light in weight, this portable tool can perform a variety of functions which make it a handy tool to have around the service shop. It drills, grinds, sands, polishes, saws, etches, etc., with the aid of accessories. The tool weighs about 3½ lbs. and has a chuck capacity up to ¼-in. Measures 7½ x 6 ins. Its design makes it usable in close quarters.—Radio-Craft



## NEW "BULL" SPEAKER

University Laboratories  
195 Christie St., New York, N. Y.

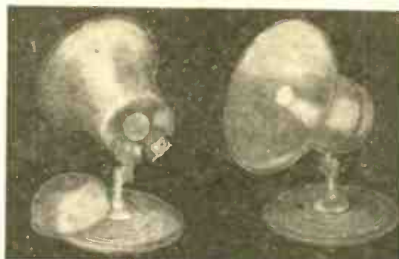

A SUPER-POWER speaker, Model 4XR designed for 100-watts continuous audio input. Acoustically, the reflexed projector is said to be equivalent to a 6-ft. straight exponential horn. Four 25-watt driver units, acoustically coupled, are used to drive the horn. Completely weather-proofed for permanent outdoor use.—Radio-Craft

## PRECISION TESTER

Precision Apparatus Co.  
647 Kent Ave., Brooklyn, N. Y.



SERIES 954 is a combination dynamic mutual conductance tube tester and a 37-range A.C.-D.C. set tester. Designed for use with both F.M. and A.M. receivers as well as with television receivers. Its single meter is of the 20,000 ohms/volt type with ranges of 6,000 volts A.C.-D.C.; 60 microamperes; 12 amperes; and, 60 megohms. Available in counter type, panel as well as portable and rack mounting models.—Radio-Craft

## ELECTRONIC MUSIC PICKUP

The Turner Company  
Cedar Rapids, Iowa



A NEW magnetic pickup, Model MM, has been designed especially for string instruments such as violins, banjos, guitars, etc. The pickup can be attached without the use of tools or adhesives. Being of high impedance, it works directly into the grid of the input tube. Has built-in volume control and can withstand severe usage. Measures 3½ x 1 5/16 ins. wide.—Radio-Craft

## 18-TUBE RECEIVER

Midwest Radio Corporation  
Cincinnati, Ohio

THIS 18-tube 5-band receiver has an output of 25 watts and boasts an "Organ-fonic Filter", dual speakers, adjustable loop antenna, static reducer, provisions

for microphone. The Organfonic Filter, it appears, is a series of multiple resonant acousti-chambers designed to enhance the tones of the loudspeaker. Organ-type pipes of proper size and shape are connected directly to the rear of the speaker to absorb peaks and further enhance the sound.—Radio-Craft

## PORTABLE RECORD PLAYER

Talk-A-Phone Mfg. Co.  
1219 W. Van Buren, Chicago, Ill.



A N all-electric record player, complete in itself, comprises phono turntable, pickup, built-in amplifier and loudspeaker—all in a single carrying case. Motor is 78 r.p.m.; table is rim-driven. Player has record compartment for eight 10-in. records. Designed for 110-120 volts, 60 cycles, A.C. only. Weight, approx. 14 lbs. Power output, 2 watts.—Radio-Craft

## TRANSMITTER KITS

Thordarson Electric Co.  
500 W. Huron St., Chicago, Ill.

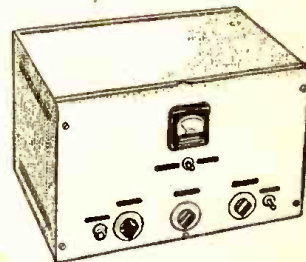

A COMPLETE series of modern transmitter kits of simplified construction. Kits consist of a 20-watt C.W. Beginners' Transmitter, 35-watt Phone or C.W. unit, 12-watt Universal for portable and emergency service, 55-watt Phone—80-watt C.W. unit, 12-watt Mobile Transmitter for the 5 and 10 meter bands, and a 50-watt Phone Transmitter for the 5 and 10 meter bands.—Radio-Craft

## DUAL-SPEED RECORDER

Allied Radio Corp.  
833 W. Jackson Blvd., Chicago, Ill.



A PROFESSIONAL-TYPE recorder, phonograph and public address system. The equipment comprises a Bruno Model BR-12 recorder and a Knight 20-watt Recording and P.A. system. Recorder cuts from outside-in at 100 lines-per-inch at both 33 1/3 and 78 r.p.m. Cuts all types of discs from 6 ins. to 12 ins. Equipped with magnetic cutting head and high-impedance pickup. Amplifier delivers 20 watts of undistort-

# • LATEST RADIO APPARATUS •

ed power. A Jensen 12-in. P.M. dynamic is employed. Designed for 110 volts, 60 cycles A.C. operation.—*Radio-Craft*

## PLUG-IN ELECTROLYTICS

Solar Manufacturing Corp.  
Bayonne, N. J.



**A** NEW series of dry electrolytic condensers in metal cans which may be plugged into a socket as easily as a radio tube. Known as Type DO, they can be easily removed for both testing and replacing. To insure rigidity of mounting for marine and aviation service, straps are available for holding the condensers in their sockets.—*Radio-Craft*

## RADIATING LOOP FOR SERVICE WORK

Radex Corporation  
1733 Milwaukee Ave., Chicago, Ill.



**T**HIS loop seems to solve the problem of how to couple the service oscillator to receivers having loop antennas when aligning them. You merely attach the shielded leads of this instrument to the output of your generator whereupon the signal is radiated from the test loop to the loop antenna of the receiver under test.—*Radio-Craft*

## RECORDIO JUNIOR

Wilcox-Gay Corporation  
Charlotte, Mich.

**A** PORTABLE home recording and radio combination having the following features: Phonograph plays 12 in. records; single speed recording at 78 r.p.m.; broadcast-band radio chassis; needle holders for cutting and playback needles; built-in antenna; high output microphone; light weight, less than 20 lbs. Size, 12¼ x 12½ x 9¾ ins.—*Radio-Craft*

## DUAL-POWER 30-WATT AMPLIFIER

Lafayette Radio Corp.  
100 6th Ave., N. Y. C.



**A** 6-VOLT D.C. and 110-volt A.C. mobile amplifier which permits permanent installations indoors and temporary installations in trucks, outdoors. No switching operation is required for changing from one power to the other. Power output 30 watts. The amplifier provides for 4 input channels (2 mike and 2 phono) with mixing and fading of 2 microphones and one phono channel. Microphone channels provide 130 db. gain; phono channels 90 db. Hum is 45 db. below 30 watts. Output impedances include 2, 4, 8, 16, 250 and 500 ohms. The phono equipment mounted on top of the amplifier case consists of a constant-speed motor, rim-driven turntable and Astatic tangent-arm crystal pickup. Size, 9 5/16 x 17¼ x 12½ ins.—*Radio-Craft*

## LATEST FILMGRAPH

Miles Reproducer Co., Inc.  
812 Broadway, New York, N. Y.



**T**HIS instrument records sound electro-mechanically on ordinary film, making it possible to play back immediately without processing. The entire recording mechanism consists of film reels and cutting head conveniently mounted on the front panel with the amplifier located inside the case. The instrument accommodates 500 ft. of film, with 40 sound tracks across the width of the film.—*Radio-Craft*

## WESTMINSTER CHIME EQUIPMENT

Chas. Jack Manufacturing Co.  
420-22 Lehigh St., Allentown, Pa.

**T**HIS equipment may be connected to any amplifier and is used in conjunction with special tubular chimes. The equipment will automatically switch on the amplifier, pre-heat the tubes every 15 minutes and then strike the Westminster melody on the quarter hour, half hour, three-quarter hour, and hour. Immediately after the 16 notes of the hour melody, it strikes the time of day. A separate clock is incorporated which au-

tomatically silences the equipment during the night. Designed mainly for installation in institutions such as colleges, churches, etc.—*Radio-Craft*

## DUAL LOUDSPEAKERS

Jensen Radio Mfg. Co.  
6601 S. Laramie Ave., Chicago, Ill.

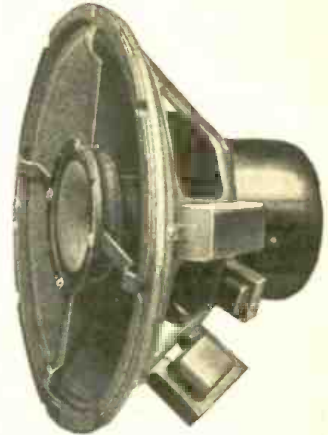

**A** COAXIAL assembly of 2 loudspeakers providing extended range, high-fidelity reproduction. Good performance up to 12,000 cycles per sec. may be obtained with this arrangement and even satisfactory reproduction in the 14,000 to 15,000 cycle range. Low-frequency response depends on the kind of baffle or cabinet employed. With a bass reflex baffle or cabinet, low-frequency reproduction in the 50-cycle range is insured. Type J Dual Speaker is capable of handling 14 to 15 watts. The low-frequency speaker is for frequencies below 2,000 c.p.s. The high-frequency speaker for frequencies above 2,000 c.p.s.—*Radio-Craft*

## JUNIOR VOLTOHMYST

RCA Manufacturing Co.  
Camden, N. J.



**T**HIS instrument employs the Rider Volt-ohmyst circuit which provides a convenient push-pull electronic D.C. Voltmeter-Ohmmeter with a resistance range ratio wide enough for both engineering and servicing requirements. Input resistance for measuring D.C. voltages is constant at 11,000,000 ohms, making it possible to read voltages in high-resistance circuits. This permits Servicemen to read A.V.C., F.M. discriminator, and many other voltages impossible with an ordinary meter. The D.C. voltmeter circuit has 6 ranges: viz., 0 to 3, 10, 30, 100, 300, and 1,000 volts. The A.C. voltage measurements may also be made on 5 scales; viz., 0 to 10, 30, 100, 300 and 1,000, at 1,000 ohms/volt.—*Radio-Craft*

Where to Buy It! —

# CLASSIFIED RADIO DIRECTORY

Handy Buying Guide, by Products and Manufacturers' Names and Addresses, for the Entire Radio Industry

There is no charge for regular light-face listings in the Classified Radio Directory. This service is absolutely free. However, if dominant bold-face listings are desired, we make a charge of \$2 for concern names and \$1 for trade names for each bold-face listing. Please write to the Advertising Dept., Radio-Craft, 20 Vesey St., New York, N. Y., for details.

This DIRECTORY is published in sections—1 section per month. This method of publication permits the DIRECTORY to be constantly up-to-date since necessary revisions and corrections can be made monthly. All names preceded by an asterisk (\*) indicate that they are trade names.

If you cannot find any item or manufacturer in this section or in previously-published sections, just drop us a line for the information.

Section I of this DIRECTORY was published in the October, 1940 issue. Presented here is Section V.

While every precaution is taken to insure accuracy, Radio-Craft cannot guarantee against the possibility of occasional errors and omissions in the preparation of this Classified Directory. Manufacturers and readers are urged to report all errors and omissions at the earliest moment to insure corrections in the very next issue.

## SPEAKERS (& PARTS)



- Accessories . . . . . A
- Acoustic chambers . . . . . AC
- Baffles . . . . . BA
- Cones . . . . . CO
- Crystal speakers . . . . . C
- Electrodynamic speakers . . . . . DS
- Field coils . . . . . FC
- Field exciters . . . . . F
- Grille cloths . . . . . G
- Horns . . . . . H
- Magnetic . . . . . MA
- Permanent-magnet dynamic . . . . . PMD
- Speaker cements . . . . . SC
- Stands . . . . . S
- Volume controls . . . . . VC

- THE ACME CO., New Haven, Conn.—FC
- ALLIED RADIO CORP., 833 W. Jackson Blvd., Chicago, Ill.—A, AC, BA, CO, DS, FC, F, G, H, MA, PMD, S
- ALLISON BAFFLE CO., 722 Berea Ave., Gadsden, Ala.—AC, BA
- AMERICAN COMMUNICATIONS CORP., 123 Liberty St., New York, N. Y.—AC, BA, F
- AMERICAN PHENOLIC CORP., 1250 Van Buren St., Chicago, Ill.—A
- AMPLIFIER CO. OF AMERICA, 175 W. 20th St., New York, N. Y.—BA
- ARLAVOX MFG. CO., 430 S. Green St., Chicago, Ill.—A, DS, FC, F, MA
- ART SPECIALTY CO., 1115 N. Franklin St., Chicago, Ill.—A, BA, CO, H, S
- ATLAS SOUND CORP., 1447 39th St., Brooklyn, N. Y.—A, AC, BA, CO, DS, FC, F, G, H, MA, PMD, S
- AUDIOGRAPH SOUND SYSTEMS, 1313 W. Randolph St., Chicago, Ill.—A, AC, BA, PMD
- AUTOCRAT RADIO CO., 3855 N. Hamilton Ave., Chicago, Ill.—PMD
- BANK'S MFG. CO., 5019 N. Winthrop Ave., Chicago, Ill.—A, BA, DS, H, PMD
- THE BENWOOD-LINZE CO., 1838 Washington Ave., St. Louis, Mo.—F
- BRUSH DEVELOPMENT CO., 3311 Perkins Ave., Cleveland, Ohio—C
- CANADIAN MARCONI CO., Montreal, Quebec, Canada—DS, MA, PMD
- CANADIAN RADIO CORP. LTD., Toronto, Ontario, Can.—FC, G
- CARRON MFG. CO., 415 S. Aberdeen St., Chicago, Ill.—A, BA, CO, FC, F
- CRESCENT TOOL & DIE CO., 4140 Belmont Ave., Chicago, Ill.—DS, PMD
- CRUMPACKER DISTRIB. CORP., 1801 Fannin St., Houston, Texas—A, BA, CO, DS, FC, G, MA, PMD, S
- HAROLD DAVIS, INC., 428 W. Capital St., Jackson, Miss.—A, AC, BA, CO, DS, FC, F, G, H, MA, PMD, S
- DOW RADIO SUPPLY CO., 1759 E. Colorado, Pasadena, Calif.—A, BA, CO, FC, G, MA
- ELECTRO PRODUCTS LABORATORIES, 549 W. Randolph St., Chicago, Ill.—VC
- ERWOOD SOUND EQUIPMENT CO., 224 W. Huron St., Chicago, Ill.—AC, BA, H, PMD, S
- FISCHER DISTRIB. CORP., 222 Fulton St., New York, N. Y.—A, AC, BA, CO, DS, FC, F, G, H, MA, PMD, S
- GENERAL CEMENT MFG. CO., 1041 Kilburn Ave., Rockford, Ill.—A, G

- GENERAL ELECTRIC CO., Schenectady, N. Y. & Bridgeport, Conn.—CO, FC, PMD
- GLOBE PHONE MFG. CORP., Reading, Mass.—PMD
- GUIDED RADIO CORP., 118 E. 25th St., New York, N. Y.—AC, BA, CO, FC, H, PMD
- HARRISON RADIO CO., 12 W. Broadway, New York, N. Y.—A, AC, BA, CO, DS, FC, F, G, H, MA, PMD, S
- HAWLEY PRODUCTS CO., 201 N. 1st Ave., St. Charles, Ill.—AC, CO, H
- A. G. HINTZE, 300 W. Adams St., Chicago, Ill.—G
- HERBERT H. HORN, 1201 S. Olive St., Los Angeles, Calif.—CO, G, H, MA, PMD
- CHARLES JACK MFG. CORP., 27 E. Philadelphia St., York, Pa.—H
- JENSEN RADIO MFG. CO., 6601 S. Laramie Ave., Chicago, Ill.—A, BA, DS, H, PMD, S
- J. F. D. MFG. CORP., 4111 Ft. Hamilton Pkwy., Brooklyn, N. Y.—FC
- LAFAYETTE RADIO CORP., 100 6th Ave., New York, N. Y.—A, AC, BA, CO, DS, FC, F, G, H, MA, PMD, S
- LEOTONE RADIO CO., 63 Dey St., New York, N. Y.—A, BA, DS, FC, MA, PMD
- THE LIFETIME CORP., 1825 Adams St., Toledo, Ohio—A, BA, H, PMD, S
- LINCROPHONE COMPANY, 1661 Howard Ave., Utica, N. Y.—BA, PMD
- T. R. McELROY, 100 Brookline Ave., Boston, Mass.—MA
- M. & H. SPORTING GOODS CO., 512 Market St., Phila., Pa.—AC, BA, CO, DS, FC, F, G, H, MA, PMD, S
- MILES REPRODUCER CO., INC., 812 B'way., New York, N. Y.—A, AC, BA, CO, DS, FC, F, H, MA, PMD, S
- MONTGOMERY WARD & CO., 619 W. Chicago Ave., Chicago, Ill.—A, BA, DS, F, H, MA, PMD, S
- MUSIC MASTER MFG. CO., 508 S. Dearborn St., Chicago, Ill.—PMD
- NASH RADIO PRODUCTS CO., 6267 Gravois Ave., St. Louis, Mo.—G
- NATIONAL COMPANY, INC., 61 Sherman St., Malden, Mass.—MA, PMD
- OFFENBACH ELECTRIC CO., 1452 Market St., San Francisco, Calif.—A, AC, BA, CO, DS, FC, F, G, H, MA, PMD, S
- OPERADIO MFG. CO., St. Charles, Ill.—BA, DS, F, H, PMD
- OXFORD-TARTAK RADIO CORP., 915 W. Van Buren St., Chicago, Ill.—DS, H, MA, PMD
- PACENT ENGINEERING CORP., 79 Madison Ave., New York, N. Y.—PMD
- PAR-METAL PRODUCTS CORP., 32-62 49th St., Long Island City, N. Y.—BA
- PHILCO RADIO & TELEVISION CORP., Tioga & "C" Sts., Phila., Pa.—A, CO, DS, FC, G, H, MA, PMD
- PHONOTONE LABS., INC., S.E. 15th St., Washington, Ind.—BA, PMD
- QUAM-NICHOLS CO., 33rd Pl. & Cottage Grove Ave., Chicago, Ill.—DS, MA, PMD
- RACON ELECTRIC CO., INC., 52 E. 19th St., New York, N. Y.—A, AC, BA, CO, DS, FC, F, H, MA, PMD
- RADIO ELECTRIC SERVICE CO., INC., N.W. Cor. 7th & Arch Sts., Phila., Pa.—A, AC, BA, CO, DS, FC, F, G, H, MA, PMD, S
- RADIO EQUIPMENT CORP., 326 Elm St., Buffalo, N. Y.—A, AC, BA, CO, DS, FC, F, G, H, MA, PMD, S
- RADOLEK COMPANY, 601 W. Randolph St., Chicago, Ill.—A, AC, BA, CO, DS, FC, F, G, H, MA, PMD, S
- RCA MFG. CO., INC., Camden, N. J.—A, BA, CO, DS, FC, F, H, MA, PMD
- JOHN A. ROEBLING'S SONS CO., 640 S. Broad St., Trenton, N. J.—FC
- ROWE INDUSTRIES, INC., 3120 Monroe St., Toledo, Ohio—AC, BA, DS, F, H, MA, PMD, S
- WALTER L. SCHOTT CO., 5264 1/2 W. Pico Blvd., Los Angeles, Calif.—SC

- MAURICE SCHWARTZ & SON, 710-712 B'way., Schenectady, N. Y.—A, AC, BA, CO, DS, FC, F, G, H, MA, PMD, S
- SETCHELL CARLSON, INC., 2233 University Ave., St. Paul, Minn.—BA, H, S
- SHELLEY RADIO CO., 1841 S. Flower St., Los Angeles, Calif.—A, AC, CO, FC, H, PMD
- MARK SIMPSON DISTRIB. CO., INC., 16 Hudson St., New York, N. Y.—BA, S
- SOUND APPARATUS CO., 150 W. 46th St., New York, N. Y.—DS, MA, PMD
- SPEAK-O-PHONE RECORDING & EQUIPMENT CO., 23 W. 60th St., New York, N. Y.—S
- STROMBERG-CARLSON TELEPHONE MFG. CO., 100 Carlson Road, Rochester, N. Y.—CO, DS, PMD
- SUN RADIO CO., 212 Fulton St., New York, N. Y.—A, AC, BA, CO, DS, FC, F, G, H, MA, PMD, S
- TRANSFORMER CORP. OF AMERICA, 69 Wooster St., New York, N. Y.—A, BA, DS, F, H, PMD, S
- UNITED TELEPHONE CORP., 150 Varick St., New York, N. Y.—AC, BA, CO, DS, FC, F, H, MA, PMD, S
- UNIVERSITY LABORATORIES, 195 Chrystie St., New York, N. Y.—AC, BA, H, PMD
- UTAH RADIO PRODUCTS CO., 820 Orleans St., Chicago, Ill.—AC, BA, CO, DS, FC, PMD
- VICTOR ANIMATOGRAPH CORP., Davenport, Iowa—BA, PMD
- THE WEBSTER-CHICAGO CORP., 5622 W. Bloomingdale Ave., Chicago, Ill., "Webster-Chicago"—BA, PMD

## SWITCHES & RELAYS



- Automatic code machines . . . . . A
- Circuit breakers . . . . . CBR
- Delay relays . . . . . D
- Mercury switches . . . . . MER
- Mercury relays . . . . . MR
- Power . . . . . PWR
- Protective . . . . . P
- Relays . . . . . REL
- Reverse-current cutouts . . . . . RCC
- Test equipment . . . . . TE
- Time . . . . . T
- Vacuum . . . . . VAC
- Wavechange (receiver) . . . . . WCR
- Wavechange (transmitter) . . . . . WCT

- ADVANCE ELECTRIC CO., 1260 W. 2nd St., Los Angeles, Calif.—CBR, P, REL, T
- ALLEN-BRADLEY CO., 1326 S. 2nd St., Milwaukee, Wis.—PWR, REL
- AMERICAN COMMUNICATIONS CORP., 123 Liberty St., New York, N. Y.—A
- AMERICAN GAS ACCUMULATOR CO., 1029 Newark Ave., Elizabeth, N. J.—T
- AMERICAN PHENOLIC CORP., 1250 Van Buren St., Chicago, Ill.—PWR
- AMERICAN TELEVISION & RADIO CO., 300 E. 4th St., St. Paul, Minn.—CBR
- BANK'S MFG. CO., 5019 N. Winthrop Ave., Chicago, Ill.—REL
- BARKER & WILLIAMSON, Ardmore, Pa.—WCT
- BOND PRODUCTS CO., 13139 Hamilton Ave., Detroit, Mich.—CBR, PWR, TE
- CANADIAN MARCONI CO., Montreal, Quebec, Can.—REL, TE, T, VAC, WCR, WCT
- CENTRALAB, DIVISION OF GLOBE UNION, INC., Milwaukee, Wisc.—TE, WCR, WCT
- CINEMA ENGINEERING CO., 1508 So. Verdugo Ave., Burbank, Calif.—TE
- CIRCLE F MFG. CO., 720 Monmouth St., Trenton, N. J.—PWR

# • CLASSIFIED RADIO DIRECTORY •

CLAROSTAT MFG. CO., 285 N. 6th St., Brooklyn, N. Y.—PWR  
 HAROLD DAVIS, INC., 428 W. Capital St., Jackson, Miss.—REL  
 DOW RADIO SUPPLY CO., 1759 E. Colorado, Pasadena, Calif.—A, REL, TE  
 DURAKOOL, INC., 1010 N. Main St., Elkhart, Ind.—MER, MR  
 ELECTRONIC CONTROL CORP., 2667 E. Grand Blvd., Detroit, Mich.—P  
 FISCHER DISTRIB. CORP., 222 Fulton St., New York, N. Y.—REL  
 GENERAL ELECTRIC CO., Schenectady, N. Y. & Bridgeport, Conn.—CBR, MER, PWR, P, REL, TE, T, VAC, WCR, WCT  
 GORDON SPECIALTIES CO., 1104 S. Wabash Ave., Chicago, Ill.—PWR, REL  
 GUARDIAN ELECTRIC CO., 1621 W. Walnut St., Chicago, Ill.—CBR, MR, P, REL, T  
 GUIDED RADIO CORP., 118 E. 25th St., New York, N. Y.—REL  
 HARRISON RADIO CO., 12 W. Broadway, New York, N. Y.—A, CBR, MER, PWR, P, REL, TE, T, VAC, WCR, WCT  
 HARTMAN ELECTRICAL MFG. CO., Mansfield, Ohio—CBR, P, REL, RCC, T  
 HEINEMANN CIRCUIT BREAKER CO., 610 Plum St., Trenton, N. J.—CBR  
 HEINTZ & KAUFMAN, LTD., South San Francisco, Calif.—WCT  
 LAFAYETTE RADIO CORP., 100 6th Ave., New York, N. Y.—A, CBR, PWR, P, REL, TE, WCR, WCT  
 LEACH RELAY CO., 5915 Avalon Blvd., Los Angeles, Calif.—CBR, D, PWR, P, REL  
 LUMENITE ELECTRIC CO., 407 S. Dearborn St., Chicago, Ill.—CBR, REL, T  
 T. R. McELROY, 100 Brookline Ave., Boston, Mass.—A, REL  
 M. & H. SPORTING GOODS CO., 512 Market St., Phila., Pa.—P, REL, TE, T, VAC, WCR, WCT  
 P. R. MALLORY & CO., INC., 3029 E. Washington St., Indianapolis, Ind.—TE, WCR, WCT  
 MEISSNER MFG. CO., Mt. Carmel, Ill.—REL, WCR  
 JAMES MILLEN MFG. CO., INC., 150 Exchange St., Malden, Mass.—T, VAC  
 MONTGOMERY WARD & CO., 619 W. Chicago Ave., Chicago, Ill.—A, PWR, REL, TE, T  
 NORTHERN ELECTRIC CO. LTD., 1261 Shearer St., Montreal, Que., Can.—PWR, REL, T, WCT  
 OAK MFG. CO., 1260 S. Clybourn Ave., Chicago, Ill.—TE, WCR, WCT  
 OFFENBACH ELECTRIC CO., 1452 Market St., San Francisco, Calif.—A, MER, REL, TE, T  
 PHILMORE MFG. CO., 113 University Place, New York, N. Y.—CBR  
 RADIO ELECTRIC SERVICE CO., INC., N. W. Cor. 7th & Arch Sts., Phila., Pa.—REL, TE  
 RADIO EQUIPMENT CORP., 326 Elm St., Buffalo, N. Y.—A, REL, TE  
 RADOLEK COMPANY, 601 W. Randolph St., Chicago, Ill.—A, CBR, MER, PWR, P, REL, TE, T  
 RCA MFG. CO., Camden, N. J.—TE  
 ROWE RADIO RESEARCH LABORATORY CO., 4201 Irving Park Blvd., Chicago, Ill.—TE, T  
 MAURICE SCHWARTZ & SON, 710-712 B'way., Schenectady, N. Y.—A, CBR, MER, PWR, P, REL, TE, T, VAC, WCR, WCT  
 SHALLCROSS MFG. CO., 10 Jackson Ave., Collingdale, Pa.—WCR, WCT  
 SHELLEY RADIO CO., 1841 S. Flower St., Los Angeles, Calif.—TE  
 STANDARD ELEC. PROD. CO., 317 Sibley St., St. Paul, Minn.—CBR, MER, PWR, P, REL, T, WCR, WCT  
 STROMBERG-CARLSON TELEPHONE MFG. CO., 100 Carlson Road, Rochester, N. Y.—REL  
 STRUTHERS DUNN, INC., 1315 Cherry St., Phila., Pa.—REL, T  
 SUN RADIO CO., 212 Fulton St., New York, N. Y.—A, CBR, MER, PWR, P, REL, TE, T, VAC, WCR, WCT  
 TORK CLOCK CO., INC., 1 Grove St., Mt. Vernon, N. Y.—MER, REL, T  
 TRANSDUCER LABS., 42 W. 48th St., New York, N. Y.—T  
 WARD LEONARD ELECTRIC CO., 31 South St., Mt. Vernon, N. Y.—PWR, P, REL, T  
 EARL WEBBER CO., 434B W. Roosevelt Rd., Chicago, Ill.—TE  
 WEBSTER ELECTRIC CO., Racine, Wis.—REL  
 WESTINGHOUSE ELECTRIC & MANUFACTURING CO., E. Pittsburgh, Pa.—CBR, MER, PWR, REL, TE, T  
 WIRT COMPANY, 5221 Greene St., Phila., Pa.—PWR, WCR

## TELEVISION



Antennas . . . . . A  
 Cabinets for television . . . . . CAB  
 Cables . . . . . CB  
 Cathode-ray tubes . . . . . CRT  
 Coaxial cables . . . . . CC  
 Coils . . . . . C  
 C.-R. tube sockets . . . . . CRTS  
 Kits . . . . . K  
 Other television tubes . . . . . OTT

Sets . . . . . S  
 Sight adapters . . . . . SA  
 Sound converters . . . . . SC  
 Television service oscillators . . . . . TSO  
 Television test meters . . . . . TTM  
 Transformers, chokes & yokes . . . . . TCY  
 Transmitters . . . . . T

ALDEN PRODUCTS CO., 715 Center St., Brockton, Mass.—CRTS, CC  
 AMERICAN COMMUNICATIONS CORP., 123 Liberty St., New York, N. Y.—A  
 AMERICAN PHENOLIC CORP., 1250 Van Buren St., Chicago, Ill.—CC  
 AMERICAN TELEVISION CORP., 130 W. 56th St., New York, N. Y.—S, CRT, TCY, T  
 ARCO TUBE CO., 227 Central Ave., Newark, N. J.—CRT, OTT  
 BARBER & HOWARD, INC., East Ave., Westerly, R. I.—C  
 BARKER & WILLIAMSON, Ardmore, Pa.—T  
 BELDEN MFG. CO., 4647 W. Van Buren St., Chicago, Ill.—A, CC  
 L. S. BRACH MFG. CORP., 55 Dickerson St., Newark, N. J.—A  
 CANADIAN MARCONI CO., Montreal, Quebec, Can.—CC  
 CASTLEWOOD MFG. CO., 12th & Burnett Sts., Louisville, Ky.—CAB  
 THE CLOUGH-BREngle CO., 5501 Broadway, Chicago, Ill.—TTM  
 CONSOLIDATED WIRE & ASSOCIATED CORP., 512 S. Peoria St., Chicago, Ill.—C, A  
 DELTA RADIO CORP., 115 Worth St., New York, N. Y.—C  
 DOOLITTLE & FALKNER, INC., 7421 Loomis Blvd., Chicago, Ill.—CC  
 ALLEN B. DU MONT LABS., INC., Passaic, N. J.—S, CRT, T  
 ESPEY MFG. CO., INC., 305 E. 63rd St., New York, N. Y.—S  
 FARNSWORTH TELEVISION & RADIO CORP., 3702 E. Pontiac St., Fort Wayne, Ind.—S, CRT, T  
 FISCHER DISTRIB. CORP., 222 Fulton St., New York, N. Y.—K, TSO, TTM, A, CC  
 FISHWICK RADIO CO., 139 W. 4th St., Cincinnati, Ohio—A, CB  
 GARDNER ELECTRIC MFG. CO., 4227 Hollis St., Oakland, Calif.—TCY  
 GENERAL ELECTRIC CO., Schenectady, N. Y. & Bridgeport, Conn.—S, SA, CRT, OTT, C, TCY, TTM, A, CC, T  
 THE HALLDORSON CO., 4500 Ravenswood Ave., Chicago, Ill.—TCY  
 HAMMOND MANUFACTURING CO., Guelph, Ontario, Canada—TCY  
 HARRISON RADIO CO., 12 W. Broadway, New York, N. Y.—S, K, SA, CRT, OTT, C, TCY, TSO, TTM, CRTS, A, CC, T  
 HYGRADE SYLVANIA CORP., 500 5th Ave., New York, N. Y.—CRT, OTT  
 INSULINE CORP. OF AMERICA, 30-30 Northern Blvd., L. I. City, N. Y.—A, CC  
 JEFFERSON ELECTRIC CO., Bellwood, Ill.—TCY  
 J. F. D. MFG. CO., 4111 Ft. Hamilton Pkwy., Brooklyn, N. Y.—A  
 KENYON TRANSFORMER CO., INC., 840 Barry St., Bronx, N. Y.—C, TCY  
 LAFAYETTE RADIO CORP., 100 6th Ave., New York, N. Y.—K, CRT, OTT, TCY, TSO, TTM, CRTS, A, CC  
 JOHN E. LINGO & SON, INC., 28th St. & Buren Ave., Camden, N. J.—A  
 M. & H. SPORTING GOODS CO., 512 Market St., Phila., Pa.—CRT, C, TCY, TSO, TTM, CC  
 MAGNETIC WINDINGS CO., 16th & Butler Sts., Easton, Pa.—C, TCY  
 MAJESTIC RADIO & TELEVISION CORP., 2600 W. 50th St., Chicago, Ill.—C, TCY  
 MEISSNER MANUFACTURING CO., Mt. Carmel, Ill.—S, K, C  
 MILES REPRODUCER CO., INC., 812 B'way., New York, N. Y.—OTT  
 J. W. MILLER CO., 5917 South Main St., Los Angeles, Calif.—K, C  
 MISSION BELL RADIO MFG. CO., INC., 831-833 Venice Blvd., Los Angeles, Calif.—S  
 MONTGOMERY WARD & CO., 619 W. Chicago Ave., Chicago, Ill.—CRT, CC  
 NATIONAL UNION RADIO CORP., 57 State St., Newark, N. J.—CRT, OTT  
 OFFENBACH ELECTRIC CO., 1452 Market St., San Francisco, Calif.—CRT, OTT, TSO, TTM, A, CC  
 PACENT ENGINEERING CORP., 79 Madison Ave., New York, N. Y.—S, A  
 PHILCO RADIO & TELEVISION CORP., Phila., Pa.—TSO, TTM, A, CC  
 RADEX CORPORATION, 1733 Milwaukee Ave., Chicago, Ill.—A  
 RADIO ELECTRIC SERVICE CO., INC., N. W. Cor. 7th & Arch Sts., Phila., Pa.—CRTS, A, CC  
 RADOLEK COMPANY, 601 W. Randolph St., Chicago, Ill.—S, K, CRT, OTT, C, TCY, TSO, TTM, CRTS, A, CC  
 RCA MANUFACTURING CO., INC., Camden, N. J.—S, K, CRT, OTT, TSO, TTM, A, T  
 MAURICE SCHWARTZ & SON, 710-712 B'way., Schenectady, N. Y.—S, K, SA, SC, CRT, OTT, C, TCY, TSO, TTM, CRTS, A, CC, T  
 SENTINEL RADIO CORP., 2020 Ridge Ave., Evanston, Ill.—S  
 SHELLEY RADIO CO., 1841 S. Flower St., Los Angeles, Calif.—S, K  
 SIMPSON ELECTRIC CO., 5216 W. Kinzie St., Chicago, Ill.—TTM

STROMBERG-CARLSON TELEPHONE MFG. CO., 100 Carlson Road, Rochester, N. Y.—S  
 SUN RADIO CO., 212 Fulton St., New York, N. Y.—S, K, SA, SC, CRT, OTT, C, TCY, TSO, TTM, CRTS, A, CC  
 TECHNICAL APPLIANCE CORP., 17 E. 16th St., New York, N. Y.—A  
 TELERADIO ENGINEERING CORP., 484-90 Broome St., New York, N. Y.—C, TCY  
 TELEVISION PRODUCTS, INC., 1135 N. Cicero Ave., Chicago, Ill.—TSO  
 THORDARSON ELECTRIC MFG. CO., 500 W. Huron St., Chicago, Ill.—TCY  
 TRANSMARINE RADIO, INC., 1184 B'way., Hewlett, L. I., N. Y.—T  
 TROY RADIO & TELEVISION CO., 1144 S. Olive St., Los Angeles, Calif.—S  
 UNITED STATES TELEVISION MFG. CORP., 220 E. 51st St., New York, N. Y.—S, C  
 VERTI-FLEX ILLINOIS SEATING CORP., 2138 N. Racine Ave., Chicago, Ill.—A  
 WARD PRODUCTS CORP., 1523 E. 45 St., Cleveland, Ohio—A  
 WESTON TELEVISION INSTRUMENT CORP., Newark, N. J.—TSO, TTM

## TEST EQUIPMENT—LABORATORY & PRODUCTION



Audiometers . . . . . A  
 Battery testers . . . . . BT  
 Bridges . . . . . BR  
 Cabinets for test equipment . . . . . CT  
 Capacity-Inductance checker (L-C) . . . . . CIC  
 Distortion meters . . . . . D  
 Field-strength meters . . . . . FS  
 Field-strength recorders . . . . . FSR  
 Frequency meters . . . . . FM  
 Frequency modulation . . . . . FRM  
 Frequency standards . . . . . F  
 Insulation testers . . . . . I  
 Interference locators . . . . . IL  
 Lab'y. amplifiers . . . . . LA  
 Lab'y. st'n'd microphones . . . . . LSM  
 Meters (laboratory type) . . . . . ML  
 Microvoltmeters . . . . . M  
 Motor-starting condenser (capacitor) selectors . . . . . MSCS  
 Oscilloscopes &/or oscillographs . . . . . OSC  
 Pocket-type line tester . . . . . PLT  
 Power-level meters . . . . . PLM  
 Sound-level meters . . . . . S  
 Square-wave generators . . . . . SWG  
 Standard signal A.F. gen. . . . . SAG  
 Standard signal R.F. gen. . . . . SRG  
 Vacuum-tube voltmeters . . . . . V  
 Voltage controllers . . . . . VC  
 Wave analyzers . . . . . W

THE ACME ELECTRIC & MFG. CO., Water St., Cuba, N. Y.—I, VC  
 AEROVOX CORPORATION, New Bedford, Mass.—BR, IL, CIC, MSCS  
 ALLEN ELEC. & EQUIP. CO., 2101 N. Pitcher St., Kalamazoo, Mich.—BT  
 ALLIED RADIO CORP., 833 W. Jackson Blvd., Chicago, Ill.—BT, BR, FS, FM, F, ML, M, OSC, S, SAG, SRG, V, W  
 AMERICAN COMMUNICATIONS CORP., 123 Liberty St., New York, N. Y.—IL  
 AMPLIFIER CO. OF AMERICA, 17 W. 20th St., New York, N. Y.—D, LA, SWG, PLM, S, SAG, V, W  
 BARKER & WILLIAMSON, Ardmore, Pa.—FS, F, V  
 BENDIX RADIO CORP., 920 E. Fort Ave., Baltimore, Md.—FM, F  
 BROWNING LABORATORIES, INC., 750 Main St., Winchester, Mass.—FM, F  
 BRUSH DEVELOPMENT CO., 3311 Perkins Ave., Cleveland, Ohio—OSC  
 CAMBRIDGE INSTRUMENT CO., INC., 3732 Grand Central Terminal, New York, N. Y.—BR, FS, FM, ML, OSC, V  
 CANADIAN MARCONI CO., 211 St. Sacrement St., Montreal, Que., Can.—BT, BR, FS, FM, F, IL, ML, OSC, S, SAG, SRG, V, W  
 CANADIAN RADIO CORP., LTD., 622 Fleet St. W., Toronto, Ont.—SAG, SRG  
 CARBON MANUFACTURING CO., 415 S. Aberdeen St., Chicago, Ill.—BR, SAG, SRG  
 CASTLEWOOD MFG. CO., 12th & Burnett Sts., Louisville, Ky.—CT  
 CINEMA ENGINEERING CO., 1508 So. Verdugo Ave., Burbank, Calif.—BR, ML, S  
 THE CLOUGH-BREngle CO., 5501 B'way., Chicago, Ill.—BT, BR, FM, F, M, OSC, SAG, SRG

# • CLASSIFIED RADIO DIRECTORY •

CRUMPACKER DISTRIB. CORP., 1801 Fannin St., Houston, Tex.—BT, OSC, SAG, SRG, V  
 DAVEN COMPANY, 158 Summit St., Newark, N. J.—BR, ML, S  
 HAROLD DAVIS, INC., 428 W. Capital St., Jackson, Miss.—OSC, SAG, SRG, V  
 DAYCO RADIO CORP., 915 Valley St., Dayton, Ohio—OSC  
 DOOLITTLE & FALKNER, INC., 7421 S. Loomis Blvd., Chicago, Ill.—FS, FM, F  
 DOW RADIO SUPPLY CO., 1759 E. Colorado, Pasadena, Calif.—BT, FS, FM, ML, OSC, V, W  
 ELECTRONIC CONTROL CORP., 2667 E. Grand Blvd., Detroit, Mich.—IL, S  
 ELECTRO-VOICE MFG. CO., INC., 1239 South Bend Ave., South Bend, Ind.—LSM  
 THE ESTERLINE-ANGUS CO., INC., Box 596, Indianapolis, Ind.—FSR, ML, SAG  
 FISCHER DISTRIB. CORP., 222 Fulton St., New York, N. Y.—BT, BR, FS, F, IL, ML, M, OSC, S, SAG, SRG, V, W  
 M. M. FLERON & SON, INC., 113 N. Broad St., Trenton, N. J.—PLT  
 GENERAL ELECTRIC CO., Schenectady N. Y.—BR, FS, FM, F, IL, ML, M, OSC, S, SAG, SRG, V, W  
 GENERAL RADIO CO., 30 State St., Cambridge, Mass.—BR, FM, F, ML, M, OSC, S, SAG, SRG, V, W  
 GUIDED RADIO CORP., 118 E. 25th St., New York, N. Y.—S  
 HARRISON RADIO CO., 12 W. B'way., New York, N. Y.—BT, FS, FM, IL, ML, M, OSC, SAG, SRG, V, W  
 HEWLETT-PACKARD CO., 367 Addison Ave., Palo Alto, Calif.—BR, F, SAG, V, W  
 HICKOK ELEC. INSTRUMENT CO., 10514 Dupont Ave., Cleveland, Ohio—BT, BR, FS, FM, ML, M, OSC, S, SAG, SRG, V, W, FRM  
 HERBERT H. HORN, 1201 S. Olive St., Los Angeles, Calif.—BR, OSC, SAG, SRG  
 INDUSTRIAL INSTRUMENTS, INC., 156 Culver Ave., Jersey City, N. J.—BR, V  
 THE JACKSON ELECTRICAL INSTRUMENT CO., 129 Wayne Ave., Dayton, Ohio—BR, OSC, SAG, V  
 KELLOGG SWITCHBOARD & SUPPLY CO., 6650 S. Cicero Ave., Chicago, Ill.—BT  
 LAFAYETTE RADIO CORP., 100 6th Ave., New York, N. Y.—BT, BR, FS, FM, F, IL, ML, M, OSC, S, SAG, SRG, V, W  
 LAMPKIN LABS., Bradenton, Fla.—FM  
 LAUREHK RADIO MFG. CO., 3918 Monroe Ave., Wayne, Mich.—SAG  
 LEEDS & NORTHRUP CO., 4970 Stenton Ave., Phila., Pa.—BR, ML  
 M. & H. SPORTING GOODS CO., 512 Market St., Phila., Pa.—BT, F, OSC, SAG, SRG, V  
 MARINE RADIO CORP., 117-19 168 St., Jamaica, N. Y.—OSC  
 MEISSNER MFG. CO., 7th & Belmont, Mt. Carmel, Ill.—F  
 JAMES MILLEN MFG. CO., INC., 150 Exchange St., Malden, Mass.—FM, F  
 MONARCH MFG. CO., 3341 Belmont Ave., Chicago, Ill.—BR, M, SRG  
 MONTGOMERY WARD & CO., 619 W. Chicago Ave., Chicago, Ill.—BT, BR, FM, F, ML, M, OSC, SAG, SRG, V, W  
 MUTER COMPANY, 1255 S. Michigan Ave., Chicago, Ill.—BR  
 NORTHERN ELECTRIC CO., LTD., 1261 Shearer St., Montreal, Que., Can.—ML  
 OFFENBACH ELECTRIC CO., 1452 Market St., San Francisco, Calif.—BT, BR, FS, FM, F, ML, M, OSC, S, SAG, SRG, V, W  
 OHMITE MFG. CO., 4835 W. Flournoy St., Chicago, Ill.—BR  
 PHILCO RADIO & TELEVISION CORP., Phila., Pa.—BT, OSC, V  
 PIERSON-DELANE, INC., 2345-47 W. Washington Blvd., Los Angeles, Calif.—FM  
 PRECISION APPARATUS CO., 647 Kent Ave., Brooklyn, N. Y.—SRG  
 RADEX CORPORATION, 1733 Milwaukee Ave., Chicago, Ill.—V  
 RADIO ELECTRIC SERVICE CO., INC., N. W. Cor. 7th & Arch Sts., Phila., Pa.—BT, BR, FM, IL, ML, M, OSC, S, SAG, SRG, V  
 RADIO ENGINEERING LABS., INC., 35-54 36 St., Long Island City, New York, N. Y.—FM  
 RADIO EQUIPMENT CORP., 326 Elm Street, Buffalo, N. Y.—BT, BR, FM, F, M, OSC, S, SAG, SRG, V  
 THE RADIOTECHNIC LABORATORY, 1328 Sherman Ave., Evanston, Ill.—SAG, SRG, V  
 RADOLEK COMPANY, 601 W. Randolph St., Chicago, Ill.—BT, BR, FS, FM, F, IL, ML, M, OSC, S, SAG, SRG, V, W  
 RCA MFG CO., INC., Camden, N. J.—FS, FM, IL, ML, M, OSC, S, SAG, SRG, V, W  
 READRITE METER WORKS, 135 E. College Ave., Bluffton, Ohio—BT  
 ROGERS-MAJESTIC CORP., LTD., 622 Fleet St., Toronto, Can.—V  
 ROWE RADIO RESEARCH LAB. CO., 4201 Irving Park Blvd., Chicago, Ill.—BR, FS, OSC, V  
 MAURICE SCHWARTZ & SON, 710-712 B'way., Schenectady, N. Y.—BT, BR, FS, FM, F, IL, ML, M, OSC, S, SAG, SRG, V, W  
 SHELLEY RADIO CO., 1841 S. Flower St., Los Angeles, Calif.—BT, BR, IL, M, OSC, SAG, SRG, V  
 SIMPSON ELECTRIC CO., 5216 W. Kinzie St., Chicago, Ill.—BT, SRG  
 SOLAR MFG. CORP., Avenue A & 25th Street, Bayonne, N. J.—BR  
 S.O.S. CINEMA SUPPLY CORP., 636 11th Ave., New York, N. Y.—FM, F, S  
 SOUND APPARATUS CO., 150 W. 46th St., New York, N. Y.—S

SPRAGUE PRODUCTS CO., N. Adams, Mass., \*\*Motor Mike"—BR, IL  
 STARK ELEC. INSTRUMENT CO., 161A King St., W., Toronto, Ont., Can.—BT, BR, V  
 SUN RADIO CO., 212 Fulton St., New York, N. Y.—BT, BR, FS, FM, F, IL, ML, M, OSC, S, SAG, SRG, V, W  
 SUPREME INSTRUMENTS CORP., 414 Howard St., Greenwood, Miss.—OSC  
 TAY BERN EQUIP. CO., INC., 135 Liberty St., New York, N. Y.—A  
 TELEVISO PRODUCTS, INC., 1135 N. Cicero Ave., Chicago, Ill.—F, M, SAG, SRG, V, W  
 TELEX PRODUCTS CO., Minneapolis, Minn.—F, OSC, SAG  
 THORDARSON ELECTRIC MFG. CO., 500 W. Huron St., Chicago, Ill.—OSC  
 TRANSFORMER CORP. OF AMERICA, 69 Wooster Street, New York, N. Y.—S  
 THE TRIPLETT ELEC. INSTRUMENT CORP., Bluffton, Ohio—BT, BR, FM, ML, M, S, SRG, V, W  
 WESTINGHOUSE ELECTRIC & MFG. CO., East Pittsburgh, Pa.—ML  
 WESTON ELECTRICAL INST. CORP., 614 Frelinghuysen Ave., Newark, N. J.—BT, FM, ML, SL, SRG, V

## TOOLS



|                            |     |
|----------------------------|-----|
| Alignment tools            | A   |
| Automatic staple driver    | AD  |
| Chassis racks and supports | CR  |
| Clips (test & battery)     | C   |
| Drills, electric           | DE  |
| Grinders                   | G   |
| Hand-drills                | HDR |
| Hole cutters               | HCT |
| Line taster (pocket type)  | LT  |
| Nut drivers                | ND  |
| Pliers                     | PL  |
| Punches                    | P   |
| Screwdrivers               | S   |
| Solder                     | SD  |
| Soldering irons, electric  | SE  |
| Soldering-iron stands      | SI  |
| Soldering paste            | SPT |
| Solder pots                | SPT |
| Wire strippers             | WST |
| Wrenches                   | W   |

ACRO TOOL & DIE WORKS, 2815 Montrose Ave., Chicago, Ill.—CR  
 AMERICAN PHENOLIC CORP., 1250 Van Buren St., Chicago, Ill.—A, HCT, P  
 BOND PRODUCTS CO., 13139 Hamilton Ave., Detroit, Mich.—SE  
 L. S. BRACH MFG. CORP., 55 Dickerson St., Newark, N. J.—SD, SE  
 BUD RADIO, INC., 5205 Cedar Ave., Cleveland, Ohio—A  
 COLE RADIO WORKS, 86 Westville Ave., Caldwell, N. J.—SE  
 CRUMPACKER DISTRIB. CORP., 1801 Fannin St., Houston, Texas—A, ND, PL, P, S, SD, SE, SI, SPS, W  
 HAROLD DAVIS, INC., 428 W. Capital St., Jackson, Miss.—A, ND, PL, P, S, SD, SE, SI, SPS, W  
 DOW RADIO SUPPLY CO., 1759 E. Colorado, Pasadena, Calif.—A, DE, HCT, ND, PL, P, S, SD, SE, SI, SPS, W  
 ELECTRIC SOLDERING IRON CO., INC., Deep River, Conn.—SE, SI  
 FEDERAL SALES CO., 26 S. Jefferson St., Chicago, Ill.—ND, SD, SPS  
 FISCHER DISTRIB. CORP., 222 Fulton St., New York, N. Y.—A, CR, DE, HDR, HCT, ND, PL, P, S, SD, SE, SI, SPS, W  
 M. M. FLERON & SON, INC., 113 N. Broad St., Trenton, N. J.—LT  
 FORSBERG MFG. CO., 125 Seaview Ave., Bridgeport, Conn.—DE, HDR, S  
 GENERAL CEMENT MFG. CO., 1041 Kilburn Ave., Rockford, Ill.—A, DE, SD, SPS, W  
 GENERAL ELECTRIC CO., Schenectady, N. Y. & Bridgeport, Conn.—SE, SI, SPS  
 HARRISON RADIO CO., 12 W. B'way., New York, N. Y.—A, DE, PL, S, SD, SE, SI, SPS, W  
 HERBERT H. HORN, 1201 S. Olive St., Los Angeles, Calif.—A, HCT, ND, PL, S, SD, SE, SI, SPS, W  
 IDEAL COMMUTATOR DRESSER CO., Sycamore, Ill.—SE  
 INSULINE CORP. OF AMERICA, 30-30 Northern Blvd., Long Island City, N. Y.—A, CR, DE, HDR, HCT, ND, PL, P, S, SE, SI, W  
 KRAEUTER & CO., INC., 563 18th Ave., Newark, N. J.—PL, P  
 LAFAYETTE RADIO CORP., 100 6th Ave., New York, N. Y.—A, CR, DE, HDR, HCT, ND, PL, P, S, SD, SE, SI, SPS, W  
 LECTROHM, INC., 5133 W. 25th Pl., Cicero, Ill.—SPT  
 MEISSNER MFG. CO., Mt. Carmel, Ill.—A, P

MISENER MFG. CO., 1747 58th St., Brooklyn, N. Y.—HCT, ND, PL, P, S, W  
 MONTGOMERY WARD & CO., 619 W. Chicago Ave., Chicago, Ill.—A, ND, PL, P, S, SD, SE, SI, SPS, W  
 MUELLER ELECTRIC CO., 1583 E. 31st St., Cleveland, Ohio—C  
 OFFENBACH ELECTRIC CO., 1452 Market St., San Francisco, Calif.—A, DE, HDR, HCT, ND, PL, P, S, SD, SE, SI, SPS, W  
 PHILCO RADIO & TELEVISION CORP., Tioga & C Sts., Phila., Pa.—A, CR, S, W  
 PYRAMID PRODUCTS CO., 2224 S. State St., Chicago, Ill.—WST  
 RADIO ELECTRIC SERVICE CO., INC., N. W. Cor. 7th & Arch Sts., Phila., Pa.—A, CR, DE, HDR, HCT, ND, PL, P, S, SD, SE, SI, SPS, W  
 RADIO EQUIPMENT CORP., 326 Elm St., Buffalo, N. Y.—A, CR, DE, HDR, HCT, ND, PL, P, S, SD, SE, SI, SPS, W  
 RADOLEK COMPANY, 601 W. Randolph St., Chicago, Ill.—A, CR, DE, HDR, HCT, ND, PL, P, S, SD, SE, SI, SPS, W  
 RCA MFG. CO., Front & Cooper Sts., Camden, N. J.—\*\*RCA"—A  
 WALTER L. SCHOTT CO., 5264 1/2 W. Pico Blvd., Los Angeles, Calif.—AD  
 MAURICE SCHWARTZ & SON, 710-712 B'way., Schenectady, N. Y.—A, CR, DE, HDR, HCT, ND, PL, P, S, SD, SE, SI, SPS, W  
 SHELLEY RADIO CO., 1841 S. Flower St., Los Angeles, Calif.—DE, HDR, HCT, PL, S, SD, SE, SI, SPS, W  
 SPEEDWAY MFG. CO., 1834 S. 52nd St., Cicero, Ill.—DE, G  
 THE STANLEY WORKS, New Britain, Conn.—HDR, HCT, P, S, SE  
 STEVENS-WALDEN, INC., 475 Shrewsbury St., Worcester, Mass.—A, HCT, PL, S, W  
 SUNDT ENGINEERING CO., 4757 Ravenswood Ave., Chicago, Ill.—NS  
 SUN RADIO CO., 212 Fulton St., New York, N. Y.—A, CR, DE, HDR, HCT, ND, PL, P, S, SD, SE, SI, SPS, W  
 HAROLD E. TRENT CO., 55th & Wyalusing Ave., Phila., Pa.—SPT  
 VACO PRODUCTS CO., 1603 S. Michigan Ave., Chicago, Ill.—ND, S  
 VANATTA MFG. CO., 516 Monterey Ave., Ontario, Calif.—SE  
 VULCAN ELECTRIC CO., 600 Broad St., Lynn, Mass.—SE, SI

## TRANSFORMERS & CHOKES



|                               |     |
|-------------------------------|-----|
| Amateur transmitting          | A   |
| Audio (receiving)             | AR  |
| Autotransformers              | AT  |
| Chokes (receiving)            | CR  |
| Coils & windings              | C&W |
| Commercial & broadcast trans. | C&B |
| Power (receiving)             | PR  |
| Specification equipment       | SE  |
| Voltage regulating            | V   |

ACME ELECTRIC & MFG. CO., Water St., Cuba, N. Y.—AR, CR, PR, V (SE)  
 THE ACME WIRE CO., 1255 Dixwell Ave., New Haven, Conn.—C&W  
 ALLIED RADIO CORP., 833 W. Jackson Blvd., Chicago, Ill., \*\*Knight"—A, AR, AT, CR, C&W, C&B, PR, V  
 AMPLIFIER CO. OF AMERICA, 17 W. 20th St., New York, N. Y., \*\*ACA"—A, AR, AT, CR, C&W, C&B, PR, V  
 ARLAVOX MFG. CO., 430 S. Green St., Chicago, Ill.—AR, AT, CR, C&W, PR  
 AUDIO DEVELOPMENT CO., 123 Bryant Ave. N., Minneapolis, Minn.—A, AR, AT, CR, C&W, C&B, PR, V  
 BANK'S MFG. CO., 5019 N. Winthrop Ave., Chicago, Ill.—AR, CR, PR  
 BOND PRODUCTS CO., 13139 Hamilton Ave., Detroit, Mich.—AR, CR  
 CANADIAN MARCONI CO., Montreal, Quebec, Can.—AR, AT, CR, C&W, C&B, PR, V  
 CANADIAN RADIO CORP., LTD., Toronto, Ontario, Can.—AR, CR, PR  
 CARRON MANUFACTURING CO., 415 S. Aberdeen St., Chicago, Ill.—A, CR, C&W  
 COLE RADIO WORKS, 86 Westville Ave., Caldwell, N. J.—AT, C&W  
 CRUMPACKER DISTRIB. CORP., 1801 Fannin St., Houston, Texas—AR, AT, PR, V  
 HAROLD DAVIS, INC., 428 W. Capital St., Jackson, Miss.—A, AR, AT, CR, C&W, C&B, PR, V  
 DELTA RADIO CORP., 115 Worth St., New York, N. Y.—CR, C&W  
 DOW RADIO SUPPLY CO., 1759 E. Colorado, Pasadena, Calif.—A, AR, CR, C&W  
 EISLER ENGINEERING CO., 750 S. 13th St., Newark, N. J.—AT, C&W  
 ELECTRONIC APPLICATIONS, Brunswick, Me.—A, AR, AT, CR, C&W, C&B, PR, V

# CLASSIFIED RADIO DIRECTORY

FISCHER DISTRIB. CORP., 222 Fulton St., New York, N. Y.—A, AR, AT, CR, C&W, C&B, PR, V  
 GARDNER ELECTRIC MFG. CO., 4227 Hollis St., Oakland, Calif.—A, AT, CR, C&W, C&B, PR, V  
 GENERAL ELECTRIC CO., Schenectady, N. Y. & Bridgeport, Conn.—AR, AT, CR, C&W, C&B, PR, V  
 GENERAL RADIO CO., 30 State St., Cambridge, Mass.—AR, AT  
 ROBERT M. HADLEY CO., 709-11 E. 61st St., Los Angeles, Calif.—A, AR, AT, CR, C&W, C&B, PR, V  
 THE HALLDORSON COMPANY, 4500 Ravenswood Ave., Chicago, Ill.—A, AR, CR, PR, V  
 HARRISON RADIO CO., 12 W. B'way., New York, N. Y.—A, AR, AT, CR, C&W, C&B, PR, V  
 HEINTZ & KAUFMAN, LTD., So. San Francisco, Calif.—C&B  
 HILET ENGINEERING CO., 34 S. Park Dr., W. Orange, N. J.—A, AR, AT, CR, C&W, C&B, PR, V  
 HOLLYWOOD TRANSFORMER CO., 5334 Hollywood Blvd., Hollywood, Calif.—A, AR, AT, CR, C&W, C&B, PR, V  
 HERBERT H. HORN, 1201 S. Olive St., Los Angeles, Calif.—AR, AT, CR, PR  
 INSULINE CORP. OF AMERICA, 30-30 Northern Blvd., Long Island City, N. Y.—A, CR, C&W  
 JEFFERSON ELECTRIC CO., Bellwood, Ill.—A, AR, AT, CR, C&B, PR  
 KENYON TRANSFORMER CO., INC., 840 Barry St., New York, N. Y.—A, AR, AT, CR, C&W, C&B, PR, V  
 LAFAYETTE RADIO CORP., 100 6th Ave., New York, N. Y.—A, AR, AT, CR, C&W, C&B, PR, V  
 M. & H. SPORTING GOODS CO., 512 Market St., Phila., Pa.—A, AR, AT, CR, C&W, C&B, PR, V  
 MAGNETIC WINDINGS CO., 16th & Butler Sts., Easton, Pa.—AR, AT, CR, C&W, C&B, PR, V  
 MAJESTIC RADIO & TELEVISION CORP., 2600 W. 50th St., Chicago, Ill.—AR, CR, C&W  
 MARINE RADIO CORP., 117-19 168th St., Jamaica, N. Y.—A, AR, AT, CR, C&W, C&B, PR, V  
 JAMES MILLEN MFG. CO., INC., 150 Exchange St., Malden, Mass.—A  
 J. W. MILLER CO., 5917 S. Main St., Los Angeles, Calif.—A, CR, C&W, C&B  
 MONTGOMERY WARD & CO., 619 W. Chicago Ave., Chicago, Ill.—A, AR, AT, CR, C&W  
 NATIONAL COMPANY, 61 Sherman St., Malden, Mass.—A, AR, CR, C&W, C&B  
 NORTHERN ELECTRIC COMPANY, LTD., 1261 Shearer St., Montreal, Quebec, Can.—C&B  
 OFFENBACH ELECTRIC CO., 1452 Market St., San Francisco, Calif.—A, AR, AT, CR, C&B, PR, V  
 PHILCO RADIO & TELEVISION CORP., Tioga & C Sts., Phila., Pa.—AR, AT, CR, C&W, PR, V  
 RADEX CORPORATION, 1733 Milwaukee Ave., Chicago, Ill.—CR  
 RADIO ELECTRIC SERVICE CO., INC., N.W. Cor. 7th & Arch Sts., Phila., Pa.—A, AR, AT, CR, C&W, C&B, PR, V  
 RADIO EQUIPMENT CORP., 326 Elm St., Buffalo, N. Y.—A, AR, AT, CR, C&W, C&B, PR, V  
 RADOLEK COMPANY, 601 W. Randolph St., Chicago, Ill.—A, AR, AT, CR, C&W, C&B, PR, V  
 ROGERS MAJESTIC CORP., LTD., 622 Fleet St., Toronto, Can.—AT, CR, C&W, PR  
 MAURICE SCHWARTZ & SON, 710-712 B'way., Schenectady, N. Y.—A, AR, AT, CR, C&W, C&B, PR, V  
 SHELLEY RADIO CO., 1841 S. Flower St., Los Angeles, Calif.—A, AR, AT, CR, C&W, C&B, PR, V  
 SOLA ELECTRIC CO., 2525 Clybourn Ave., Chicago, Ill.—V  
 STANDARD ELECTRICAL PRODUCTS CO., 317 Sibley St., St. Paul, Minn.—V  
 STANDARD TRANSFORMER CORP., 1500 N. Halsted St., Chicago, Ill.—A, AR, AT, CR, C&W, C&B, PR, V  
 STROMBERG-CARLSON TELEPHONE MFG. CO., 100 Carlson Road, Rochester, N.Y.—A  
 SUN RADIO CO., 212 Fulton St., New York, N. Y.—A, AR, AT, CR, C&W, C&B, PR, V  
 TELERADIO ENGINEERING CORP., 484-90 Broome St., New York, N. Y.—CR, C&W  
 THORDARSON ELECTRIC MFG. CO., 500 W. Huron St., Chicago, Ill.—A, AR, AT, CR, C&W, C&B, PR, V  
 TILTON ELECTRIC CORP., 15 E. 26th St., New York, N. Y.—AR, CR, PR  
 UNITED TRANSFORMER CORP., 150 Varick St., New York, N. Y.—A, AR, AT, CR, C&W, C&B, PR, V  
 UTAH RADIO PRODUCTS CO., 812 Orleans St., Chicago, Ill.—A, AR, CR, PR  
 WEBSTER ELECTRIC CO., Clark & DeKoven Aves., Racine, Wis.—AR, AT, CR, C&W, C&B, PR, V  
 WESTINGHOUSE ELECTRIC & MFG. CO., E. Pittsburgh, Pa.—AT, C&B, V

Broadcast (transmitters) . BX  
 Commercial (transmitters) . CX  
 Control consoles . C  
 Crystals . XTAL  
 Facsimile . F  
 F.M. (transmitters) (see Frequency Modulation)  
 Frequency control equip'm't. . FCE  
 Frequency measurements . FME  
 Insulators . INS  
 Marine radiophones . MR  
 Marine (transmitters) . MX  
 Police (transmitters) . PX  
 Rotary beam antenna . RBA  
 Speech amplifiers . S  
 Telegraph keys . TK  
 Television . TEL  
 Towers . TO  
 Transmission monitor equipment . TME  
 Vertical radiators . V

ALLIED RADIO CORP., 833 W. Jackson Blvd., Chicago, Ill.—"Knight"—AX, K, ANT, AVX, BX, CX, C, XTAL, FCE, TEL, F, FME, INS, MX, PX, S, TO, TK, TME, V  
 AMERICAN COMMUNICATIONS CORP., 123 Liberty St., New York, N. Y.—AX, K, ANT, AVX, BX, CX, C, MX, PX, TK  
 AMERICAN LAVA CORP., Cherokee Blvd. & Manufacturers Rd., Chattanooga, Tenn.—INS  
 AMERICAN PHENOLIC CORP., 1250 Van Buren St., Chicago, Ill.—INS  
 AMERICAN TELEVISION CORP., 130 W. 56th St., New York, N. Y.—TEL  
 AMPLIFIER CO. OF AMERICA, 17 W. 20th St., New York, N. Y.—S  
 BARKER & WILLIAMSON, Ardmore, Pa.—AX, AVX, BX, CX, FCE, TEL, FME, INS, MX, PX, S, TME  
 REX BASSETT, INC., Miles, Mich.—AX, ANT, AVX, MX, PX, TO, V  
 BENDIX RADIO CORP., 920 E. Fort Ave., Baltimore, Md.—AVX  
 BLAW-KNOX COMPANY, Pittsburgh, Pa.—TO, V  
 BLILEY ELECTRIC CO., Union Station Bldg., Erie, Pa.—XTAL  
 L. S. BRACH MFG. CORP., 55 Dickerson St., Newark, N. J.—ANT  
 BROWNING LABORATORIES, INC., 750 Main St., Winchester, Mass.—K  
 BUD RADIO, INC., 5205 Cedar Ave., Cleveland, Ohio—AX, K  
 CANADIAN MARCONI CO., Montreal, Quebec, Can.—TK, AX, ANT, AVX, BX, CX, C, XTAL, FCE, TEL, MX, PX, S, TO, TME, V  
 CANADIAN RADIO CORP., LTD., Toronto, Ontario, Can.—RR, TX, M  
 CINEMA ENGINEERING CO., 1508 S. Verdugo Ave., Burbank, Calif.—S  
 HAROLD DAVIS, INC., 428 W. Capital St., Jackson, Miss.—AX, K, ANT, AVX, BX, CX, XTAL, FCE, PX, S, TO, V, TK  
 DOOLITTLE & FALKNER, INC., 7421 S. Loomis Blvd., Chicago, Ill.—BX, CX, C, FCE, FME, PX, S, TME  
 DOW RADIO SUPPLY CO., 1759 E. Colorado, Pasadena, Calif.—TK, K, ANT, CX, XTAL, INS  
 ELECTRONIC APPLICATIONS, Brunswick, Me.—S  
 FARNSWORTH TELEVISION & RADIO CORP., 3700 Pontiac St., Fort Wayne, Ind.—AVX, BX, CX, TEL, MX, PX  
 FEDERAL TELEGRAPH CO., 200 Mt. Pleasant Ave., Newark, N. J.—BX, CX, MX  
 FINCH TELECOMMUNICATIONS, INC., Passaic, N. J.—F  
 FISCHER DISTRIB. CORP., 222 Fulton St., New York, N. Y.—TK  
 FISHER RESEARCH LABS., Palo Alto, Calif.—CX, MX  
 GENERAL CERAMICS CO., Plant No. 3, Keasbey, N. J.—INS  
 GENERAL ELECTRIC CO., Bridgeport, Conn. & Schenectady, N. Y.—ANT, AVX, BX, CX, XTAL, FCE, TEL, FME, INS, MX, PX, S, TME  
 HALLICRAFTERS, INC., 2611 S. Indiana St., Chicago, Ill.—AX, CX, MR  
 HAMMARLUND MFG. CO., INC., 424 W. 33rd St., New York, N. Y.—AX, K  
 D. H. HARRELL, 1527 E. 74th Place, Chicago, Ill.—ANT, V  
 HARRISON RADIO CO., 12 W. B'way., New York, N. Y.—AX, K, ANT, AVX, CX, XTAL, FCE, TEL, INS, MX, PX, S, TME, V  
 HARVEY RADIO LABS., INC., 25 Thorndike St., Cambridge, Mass.—AX, AVX, BX, XTAL, FCE, MX, PX  
 HARVEY-WELLS COMMUNICATIONS, INC., Southbridge, Mass.—AX, AVX, CX, MX, PX, S  
 HEINTZ & KAUFMAN, LTD., South San Francisco, Calif.—CX, MX, PX  
 HIPOWER CRYSTAL CO., 2020 Engineering Bldg., Chicago, Ill.—XTAL  
 INSULINE CORP. OF AMERICA, 30-30 Northern Blvd., Long Island City, N. Y.—ANT, INS  
 CHARLES F. JACOBS, 270 Lafayette St., New York, N. Y.—AFS  
 RAY JEFFERSON, INC., 182 Milburn Ave., Baldwin, N. Y.—MX, PX  
 KAAR ENGINEERING CO., 619 Emerson St., Palo Alto, Calif.—AX, XTAL, MX, PX  
 KENYON TRANSFORMER CO., INC., 840 Barry St., New York, N. Y.—K

LAFAYETTE RADIO CORP., 100 6th Ave., New York, N. Y.—AX, K, ANT, XTAL, FCE, TEL, FME, INS, MX, S, TME, TK, V  
 JOHN E. LINGO & SON, INC., Camden, N. J.—ANT, TO, V  
 FRED M. LINK, 125 W. 17th St., New York, N. Y.—ANT, BX, CX, XTAL, PX, TME  
 T. R. McELROY, 100 Brookline Ave., Boston, Mass.—AX, K, CX, F, TK, TME  
 M. & H. SPORTING GOODS CO., 512 Market St., Phila., Pa.—AX, K, ANT, XTAL, INS, MX, TK, V  
 MARINEPHONE, INC., 123 Liberty St., New York, N. Y.—MX  
 MARINE RADIO CORP., 117-119 168th St., Jamaica, N. Y.—AX, AVX, BX, CX, C, FCE, MX, PX, S, TME  
 JAMES MILLEN MFG. CO., INC., 150 Exchange St., Malden, Mass.—AX, K, AVX, CX, FCE, INS, S  
 MIMS RADIO CO., P. O. Box 504, Texarkana, Ark.—ANT, RBA  
 MONTGOMERY WARD & CO., 619 W. Chicago Ave., Chicago, Ill.—AX, K, ANT, XTAL, FCE, INS, MX, S, TK, V  
 NATIONAL COMPANY, 61 Sherman St., Malden, Mass.—AX, K, CX, INS, MX, PX, S, TME  
 NORTHERN ELECTRIC CO., LTD., 1261 Shearer St., Montreal, Que., Can.—TK, ANT, AVX, BX, CX, XTAL, FCE, INS, PX, S, TO, TME, V  
 OFFENBACH ELEC. CO., 1452 Market St., San Francisco, Calif.—TK, AX, K, ANT, AVX, BX, CX, XTAL, E, INS, MX, S, V  
 PETERSEN RADIO CO., 205 N. 17th St., Council Bluffs, Ia.—XTAL  
 PHILMORE MFG. CO., INC., 113 University Pl., New York, N. Y.—TK  
 PIERSON-DeLANE, INC., 2345 W. Washington Blvd., Los Angeles, Calif.—AVX, CX, FCE, FME, PX  
 PRECISION PIEZO SERVICE, 427 Asia St., Baton Rouge, La.—XTAL, FCE  
 PREMAX PRODUCTS DIV., Chisholm-Ryder Co., Inc., Niagara Falls, N. Y.—ANT, INS, TO, V  
 RADIO ELECTRIC SERVICE CO., INC., N. W. Cor. 7th & Arch Sts., Phila., Pa.—AX, K, ANT, XTAL, TK  
 RADIO ENGINEERING LABS., INC., 35-54 36th St., Long Island City, N. Y.—ANT, AVX, BX, CX, C, FCE, MX, PX, S, TME  
 RADIO EQUIPMENT CORP., 326 Elm St., Buffalo, N. Y.—TK, AX, K, ANT, AVX, BX, CX, XTAL, FCE, MX, S, V  
 RADIO NAVIGATIONAL INSTRUMENT CORP., 500 5th Ave., New York, N. Y.—AX, MX  
 RADIO TRANSCIVER LABS., 86-27 115th St., Richmond Hill, N. Y.—AX, K, ANT, CX  
 RADOLEK COMPANY, 601 W. Randolph St., Chicago, Ill.—AX, K, ANT, C, XTAL, EME, INS, TK, S  
 RCA MFG. CO., INC., Front & Cooper Sts., Camden, N. J.—AX, ANT, AVX, BX, CX, C, XTAL, FCE, TEL, F, FME, MX, PX, S, TME  
 ROWE INDUSTRIES, INC., 3120 Monroe St., Toledo, Ohio—AX, S  
 MAURICE SCHWARTZ & SON, 710-712 B'way., Schenectady, N. Y.—AX, K, ANT, AVX, BX, CX, C, XTAL, FCE, TEL, F, FME, INS, MX, PX, S, TK, TO, TME, V  
 SHELLEY RADIO CO., 1841 S. Flower St., Los Angeles, Calif.—AX, K, ANT, CX  
 SPEAK-O-PHONE RECORDING & EQUIPMENT CO., 23 W. 60th St., New York, N. Y.—PX  
 STANDARD PIEZO CO., Cedar & Louther Sts., Carlisle, Pa.—XTAL, FCE, FME  
 STANDARD TRANSFORMER CORP., 1500 N. Halsted St., Chicago, Ill.—K  
 SUN RADIO CO., 212 Fulton St., New York, N. Y.—AX, K, ANT, BX, CX, C, XTAL, FCE, TEL, FME, INS, MX, PX, S, TK, TO, TME, V  
 TAY BERN EQUIPMENT CO., INC., 135 Liberty St., New York, N. Y.—AVX, CX, MX, PX  
 TAYLOR AIRPHONE PRODUCTS, Hangar 15, Long Beach Airport, Long Beach, Calif.—AVX, CX, XTAL  
 TECHNICAL PRODUCTS INTERNATIONAL, 135 Liberty St., New York, N. Y.—AX, K, ANT, AVX, BX, CX, MX, PX, S  
 TELEVISION CO., 341 N. Pulaski Rd., Chicago, Ill.—FCE, FME  
 THORDARSON ELECTRIC MFG. CO., 500 W. Huron St., Chicago, Ill.—AX, K, S  
 TRANSFORMER CORP. OF AMERICA, 69 Wooster St., New York, N. Y.—C, S  
 TRANSMARINE RADIO, INC., 1184 B'way., Hewlett, L. I., N. Y.—AX, AVX, BX, CX, TEL, MX, PX, V  
 UNITED TRANSFORMER CORP., 150 Varick St., New York, N. Y.—K, S  
 VERTI-FLEX ILLINOIS SEATING CO., 2138 N. Racine Ave., Chicago, Ill.—ANT  
 THE VIBROPLEX CO., INC., 832 Broadway, New York, N. Y.—TK (semi-automatic)  
 WEBSTER ELECTRIC CO., Clark & De Koven Aves., Racine, Wis.—S  
 WESTINGHOUSE ELEC. & MFG. CO., E. Pittsburgh, Pa.—ANT, AVX, BX, CX, C, FCE, PX  
 WINCHARGER CORPORATION, Sioux City, Iowa—ANT, TO, V

## TRANSMITTERS (& EQUIPMENT)



Amateur (transmitters) . AX  
 Amateur kits . K  
 Antennas . ANT  
 Antenna and feeder spreader . AFS  
 Aviation (transmitters) . AVX

## NEXT MONTH: Sec. VI, March '41

Tubes (& Parts)  
 Vibrators  
 Wire  
 Literature  
 (See page 512 for preceding listings.)



LOCATING NOISE.

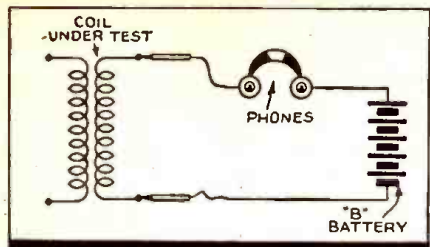

● I HAVE found earphones connected in series with a "B" battery and a pair of test leads, as shown in the diagram, to be the best method of locating noisy R.F., oscillator and I.F. coils. The radio set under test is disconnected from the power supply and a test is made across each winding of each coil, and also from the primary to the secondary winding. The same method may be used in locating noisy resistors and condensers.

HADLEY M. HOPPER,  
Hopper's Radio Shop,  
Herrick, Ill.

INTER-OFFICE COMMUNICATION SYSTEM

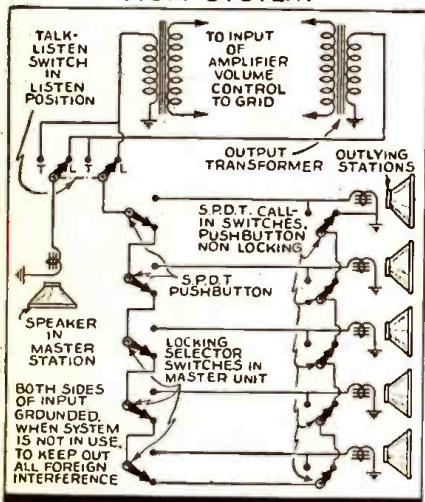

● THE main feature of this circuit is a quiet, noise-free master station, if the amplifier used is constructed for minimum hum. Shielded wire is not used on the outlying station runs as both sides of the primary of the input transformer are grounded when the system is not in use. When an outlying station calls in or is selected at the master station, the ground circuit, in series with all selector and call-in switches, is broken.

JACK C. FACLIE,  
Pleasanton, Texas

CONNECTING THAT PHONO PICKUP

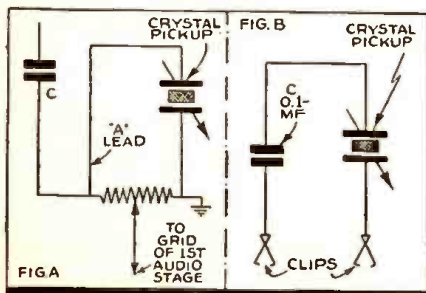

● TO SAVE time when adding phonograph pickups to radio receivers, place the pickup across the volume control, as shown at A in the illustration above.

If the pickup is a crystal, care must be

taken to get the "A" lead on the correct side of condenser C to keep direct current out of the crystal. When in doubt place a 0.1-mf. condenser in series with the "A" lead as shown at B.

To experiment for the best pickup connection place a 0.1-mf. condenser in series with the "A" lead and put clips on the pickup leads and make connections on the receiver where best reception is obtained.

D. A. LAMONICA, Norristown, Pa.

NOVEL USE FOR CROCHETING NEEDLE

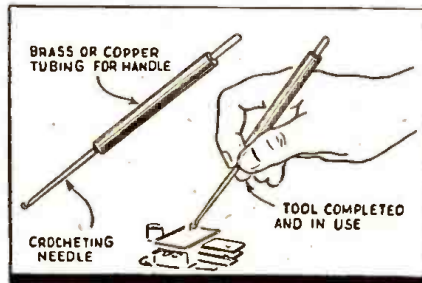

● A VERY handy tool around my workbench is a little device made from an ordinary crocheting needle and a piece of round brass. I obtained a piece of round brass about 2½ ins. long with a hole passing through the center the entire length of the piece. I then placed it upon the crocheting needle in such a way as to make a handle for the crocheting needle out of the piece of brass. The sketch illustrates the completed device which makes a very handy tool for work on small parts when a hook is essential, as when placing a spring on a device. It also serves as an excellent pick.

WM. NAKEN, Chicago, Ill.



Complete Selections . . . Guaranteed Quality

Replacement Parts



Everything you need in exact duplicate or universal replacement or repair parts. Tubes, condensers, resistors, transformers, hardware, tools, etc. Leading brands.

Latest Radio Sets



A model for every purse and purpose. Auto Sets, Midgets, Battery Portables, Table Models, Consoles, Phono-Radio and recorder combinations—for operation on AC or DC.

Public Address Equipment



A complete line of amplifiers, microphones, baffles, recording equipment and accessories for every type of installation—permanent, portable and mobile, from 5 to 100 watts.

Newest Electric Appliances



Extra profits for you! Standard Brand Electric Irons, Grills, Toasters, Percolators, Waffle Irons, Vacuum Cleaners, Clocks, Mixers and many others, all at lowest prices.

YOU SAVE MONEY AT RADOLEK

MAIL THIS COUPON TODAY

The RADOLEK CO.  
601 W. Randolph St., Chicago, Dept. C-50  
Send the New 1941 Radio Profit Guide FREE.  
Name.....  
Address..... Dealer?.....  
Experimenter?..... Serviceman?..... Amateur?.....

JUST PUBLISHED!

A NEW BOOK TO ADD TO YOUR TECHNICAL LIBRARY

AUTOMOBILE RADIO—Principles & Practice

by B. Baker Bryant

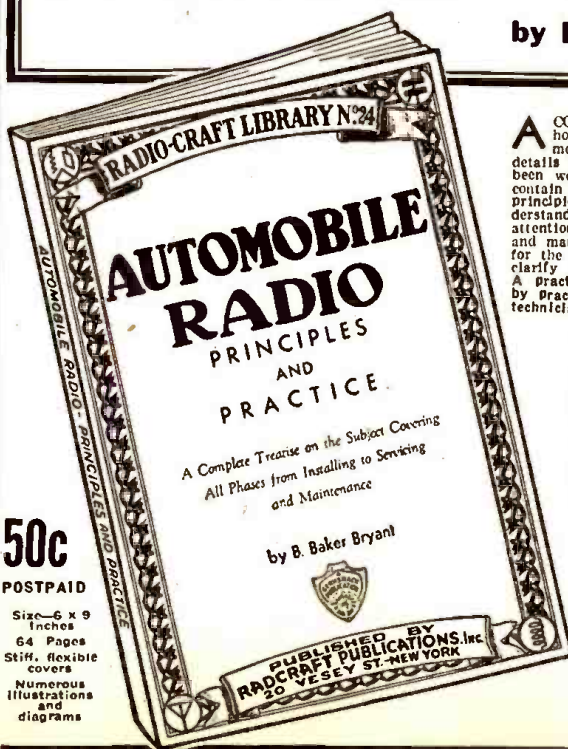

A COMPLETE compilation of pertinent data on how to install and service the modern automobile radio receiver. All of the non-essential details which have crept into the profession have been weeded out. Each topic is treated so as to contain a precise statement of the fundamental principle involved, to assure the reader's clear understanding of this principle, without distracting his attention by the discussion of a multitude of details and mathematical expressions, which are primarily for the engineer, and tend to confuse rather than clarify a statement for the auto-radio-technician. A practical treatise based on practical experience by practical radio people for the practical radio-technician.

Brief Outline of Contents—

- Introduction—The Auto-Radio Art.
- Features of the Modern Automobile Receiver.
- Installations of Automobile Radios and Antenna.
- The Automobile High and Low Tension Electrical Systems.
- Automobile Electrical Disturbances.
- Vibrator Converters and Motor Generators.
- Service Hints. Classified Automobile Installation Notes, and Conclusion.

Send 50c check, money order, unused U. S. stamps, or coin for your copy of "Automobile Radio—Principles & Practice"—it will be sent to you postpaid upon receipt of your remittance.

**RADCRAFT PUBLICATIONS, Inc.**  
20 Vesey Street, New York, N. Y.

# GEOPHYSICAL PROSPECTING OUTFITS



## BLUE PRINTS and INSTRUCTIONS

For Building the Following Treasure Finders and Prospecting Outfits

- Folder No. 1. The "Radioflexor Pilot"—consists of a 2-tube transmitter and 3-tube receiver. Principle: radiated Wave from transmitter loop is reflected back to receiver loop. Emits visual and aural signals. Tubes used: two 1A5G—two 1N5G—one 1H5G.
- Folder No. 2. The "Harmonic Frequency Locator"—Transmitter radiates low frequency wave to receiver, tuned to one of Harmonics of transmitter. Using regenerative circuit. Emits aural signals. Tubes used: one 1G6G—one 1N5G.
- Folder No. 3. The "Beat-Note Indicator"—Two oscillators so adjusted as to produce beat-note. Emits visual and aural signals. Tubes used: Three type '30.
- Folder No. 4. The "Radio-Balance Surveyor"—a modulated transmitter and very sensitive loop receiver. Principle: Balanced loop. Emits visual and aural signals. By triangulation depth of objects in ground can be established. Tubes used: Seven type '30.
- Folder No. 5. The "Variable Inductance Monitor"—a single tube oscillator generating fixed modulated signals and receiver employing two stages R.F. amplification. Works on the inductance principle. Emits aural signals. Tubes used: six type '30.
- Folder No. 6. The "Hughes Inductance-Balance Explorer"—a single tube Hartley oscillator transmitter and sensitive 3-tube receiver. Principle: Wheatstone bridge. Emits aural signals. Tubes used: two type '30—one type '32—one type '33.
- Folder No. 7. The "Radiodyne Prospector"—a completely shielded instrument. Principle: Balanced loop. Transmitter, receiver and batteries enclosed in steel box. Very large field of radiation and depth of penetration. Emits aural signals. Tubes used: two 1N5G—one 1G4G—one 1H5G—one 1Q5—one 1G4.

With any one of the modern geophysical methods described in the Blue-Print patterns, Radio outfits and instruments can be constructed to locate metal and ore deposits (prospecting); finding lost or buried treasures; metal war relics; sea and land mines and "duds"; mineral deposits; subterranean water veins; oil deposits (under certain circumstances); buried gas and water pipes; tools or other metallic objects sunken in water, etc., etc.

Each set of blueprints and instructions enclosed in heavy envelope (9 1/2" x 12 1/2"). Blueprints 22" x 34"; eight-page illustrated 8 1/2" x 11" folder of instructions and construction data... **50¢**  
Add 5¢ for postage

The complete set of seven folders..... **\$3.00**  
Shipping weight 2 lbs. (add 25¢ for shipping anywhere in U.S.A.)

## TECHNIFAX

1917 S. STATE ST. CHICAGO, ILL.

TECHNIFAX 1917 So. State, Chicago, Ill.

Enclosed herewith \$..... for which mail to address below:  
Treasure Finder No. 1, 2, 3, 4, 5, 6, 7.  
Complete set of seven folders.

NAME .....

ADDRESS .....

CITY ..... STATE .....

RC-241

**THE METER AT WORK**, by John F. Rider (1940). Published by John F. Rider Publisher, Inc. Size 8 1/2" x 5 1/4" ins., cloth cover, 152 pages. Price, \$1.25.

Here is a book that fills a long-standing demand and introduces 2 novelties in book making. Servicemen especially will be interested in this book.

Radio men now have available in this novel book an up-to-date, accurate and understandable presentation of the principles underlying the functioning of meters. In addition to describing how each type of meter works, this book also describes how to get the most from meters technicians now own, and discusses the points to consider in selecting new meters.

The outstanding novelty of "The Meter at Work" is 2-fold; in the first place, the book is substantially 2 books, one above the other between common covers, and in the second, the wrapper has printed on it 2 charts which readers will find of use in regard to repulsion-iron and moving-coil meters. The importance of the "2 books in one" construction, a new departure in book making, is that the reader can keep in front of him any diagram in the upper or illustrations "book" while reading several pages in description of this illustration in the lower or text "book."

Chapters: I, General Considerations; II. Moving-Iron Meters; III. Moving-Coil Meters; IV. Electrodynamometer Meters; V. The Electrostatic Meter; VI. Thermal Meters; VII. Components of Meters; VIII. Characteristics of Meters; IX. Rectifiers and Thermocouples; X. Practical Applications of Meters.

**AP, THE STORY OF NEWS**, by Oliver Gramling (1940). Published by Farrar and Rinehart, Inc. Size 6 x 9 ins., hard cover, profusely illustrated, 506 pages. Price, \$3.50.

The life story of the gigantic news gathering agency known as the Associated Press is brought to light in this book.

In tracing the story to its end, radio is given its proper place in the sun. Not only broadcasting and communications are mentioned, but also the commercial form of facsimile known as the wirephoto is described from its first uncertain steps to its present status as an essential service that almost instantly flashes news pictures by wire and by radio between points all over the globe.

## Preceding Listings in RADIO-CRAFT'S CLASSIFIED RADIO DIRECTORY

**Sec. I, Oct. '40:**  
Antennas & Accessories  
Automatic Tuners & Parts  
Auto-Radio Controls  
Battery Chargers, Eliminators & Rectifiers  
Batteries, Dry & Wet  
Cabinets  
Coils & Transformers (R.F. & I.F.), & Accessories

**Sec. II, Nov. '40:**  
Condensers (Variable)  
Crystals (Quartz)  
Dials & Parts  
Electric Fence Controllers  
Electric-Generating Machines  
Electronics  
Electronic Musical Instruments & Parts  
Frequency Modulation Equipment  
Hardware—Connectors & Misc. Parts  
Headphones  
Hearing-Aids  
Hearing-Aid Parts  
Insulation  
Intercommunicating Systems  
Line Filters

**Sec. III, Dec. '40:**  
Magnets  
Metal & Special Fittings (for Radio)  
Metal, Ore & Oil Locators  
Microphones  
Noise Elimination Equipment  
Paint, Cement & Wax Products  
Plastics  
Plastic Molders  
Radio Logs, Maps & Globes  
Receiving Sets (including Adapters & Converters)  
Records & Record-Playing Equipment

**Sec. IV, Jan. '41:**  
Recording Equipment  
Resistors & Volume Controls (Attenuators & Networks)  
Schools  
Service Manuals, Books & Magazines  
Servicing Equipment  
Sound Systems, Amplifiers & Accessories

## Index to advertisers

### PUBLIC ADDRESS EQUIPMENT

|                                    |     |
|------------------------------------|-----|
| Amplifier Co. of America.....      | 492 |
| General Industries Co.....         | 491 |
| John Meek Industries.....          | 487 |
| Miles Reproducer Co.....           | 492 |
| Music Master Mfg. Co.....          | 487 |
| Universal Microphone Co., Ltd..... | 492 |
| University Laboratories.....       | 492 |

### PUBLISHERS

|                                 |               |
|---------------------------------|---------------|
| Audel, Publishers.....          | 452           |
| Data Print Co.....              | 497           |
| Miller, Wayne.....              | 451           |
| National Plans Inst.....        | 485           |
| Radcraft Publications, Inc..... | 454, 488, 511 |
| Radio & Technical Pub. Co.....  | 451, 453      |
| Supreme Publications.....       | 497           |
| Technifax.....                  | 492, 512      |

### RADIO PARTS

|                               |     |
|-------------------------------|-----|
| Aerovox Corporation.....      | 474 |
| Amperite Co.....              | 472 |
| Hammarlund Mfg. Co.....       | 472 |
| Solar Mfg. Corp.....          | 474 |
| Sprague Products Company..... | 485 |

### RADIO SETS

|  |     |
|--|-----|
| Goldentone Radio Co.....                       | 485 |
| Midwest Radio Corp.....                        | 479 |
| Radio Electric Service Co., Inside Front Cover |     |
| RCA Manufacturing Co., Inc., Back Cover        |     |

### RADIO SUPPLY HOUSES

|                               |     |
|-------------------------------|-----|
| Allied Radio Corp.....        | 463 |
| Burstein-Anplebee Co.....     | 474 |
| Hudson Specialties Co.....    | 502 |
| Lafayette Radio Corp.....     | 479 |
| Radolek Co.....               | 511 |
| Sears, Roebuck & Company..... | 467 |
| Montgomery Ward & Co.....     | 491 |

### SCHOOLS

|                                 |     |
|---------------------------------|-----|
| Capitol Radio Eng. Inst.....    | 453 |
| Lincoln Engineering School..... | 452 |
| National Radio Institute.....   | 449 |
| National Schools.....           | 451 |
| New York Y.M.C.A. Schools.....  | 452 |
| Radio Training Assoc.....       | 452 |
| RCA Institutes.....             | 451 |
| Sprayberry Academy of Radio     |     |
| Inside Back Cover               |     |

### TEST EQUIPMENT

|                                       |          |
|---------------------------------------|----------|
| Meissner Mfg. Company.....            | 462      |
| Radio City Products Co.....           | 477      |
| Readrite Meter Works.....             | 472      |
| Superior Instruments Co.....          | 473, 475 |
| Supreme Instruments Corp.....         | 465      |
| Triplet Electrical Instrument Co..... | 469      |

### TUBES

|                                |     |
|--------------------------------|-----|
| Hygrade Sylvania Corp.....     | 474 |
| National Union Radio Corp..... | 487 |

### MISCELLANEOUS

|                                       |     |
|---------------------------------------|-----|
| Atlas Press Co.....                   | 494 |
| Bridge, Harry P.....                  | 452 |
| Classified Section.....               | 500 |
| Flight Magazine.....                  | 479 |
| Lancaster, Allwine & Rommel.....      | 472 |
| Paramount Products Co.....            | 494 |
| Premium Distributing Service.....     | 504 |
| Radio Servicemen of America, Inc..... | 482 |
| Remington Rand Inc.....               | 478 |
| Woodstock Typewriter Co.....          | 491 |

(While every precaution is taken to insure accuracy, we cannot guarantee against the possibility of an occasional change or omission in the preparation of this index.)

# FULL EQUIPMENT

## Included WITH

# SPRAYBERRY RADIO TRAINING!

*Experience Easily Acquired at Home!*

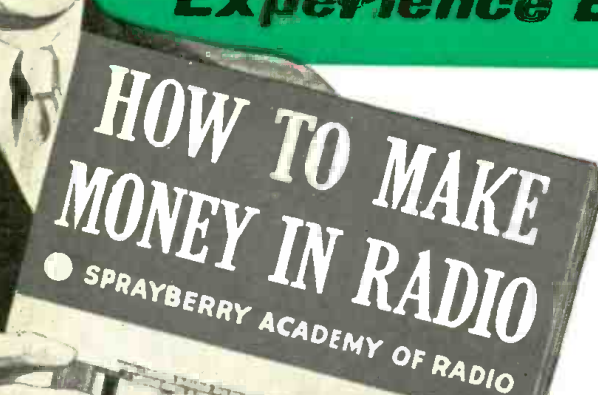

## OVER 100 EXPERIMENTS

plus Many Other Special Features

ALL DESIGNED TO HELP YOU MAKE FAST PROGRESS!

SPRAYBERRY Training starts right at the beginning of Radio . . . unfolds each subject in a simplified, logical, understandable style. You easily learn Television, Frequency Modulation, Signal Tracing, Mobile Radio (Auto-Tank), Aviation Radio, Electronics, Facsimile Radio, Radio Set Repair and Installation Work. You learn quickly in your spare hours . . . AT HOME OR AT CAMP.

**Training Prepares You for a Business of Your Own . . . Or Good Radio Jobs at Excellent Pay!**

The great, fascinating and progressive field of Radio and Television offers many opportunities to the man who wants to get ahead. There is good money to be made. My Training is designed to give you quick access to these opportunities. SPRAYBERRY Methods are thorough and practical. Your Training will not interfere with your present work.

**You Get Professional Test Equipment plus Experimental Outfits!**

. . . Includes 146 RADIO PARTS for building a complete Receiver, RADIO TOOLS and a modern TESTER-ANALYZER. You also receive 8 BIG SHIPMENTS OF RADIO EQUIPMENT for conducting actual experiments with your own hands. I show you how to create Radio defects . . . how to correct them. This practical "beforehand" experience will come in handy again and again when you are called on to do actual Radio repair work later on.



### READ WHAT THESE FELLOWS SAY ABOUT THE NEW PRACTICAL SPRAYBERRY TRAINING



**EARNED \$250 SINCE STARTING**

"I have only completed one-third of the Sprayberry Course and I find it very interesting, which makes it easy to learn. By devoting several hours of my spare time daily to studying and servicing, I have made about \$250 gross since starting the Course." Earl W. Hostetter, Rt. No. 4, Lebanon, Pa.

**"SO MUCH FOR SO LITTLE"**

"Now just a few words about your Course—the more I get on it, the more I wonder how you can give so much for so little. I believe it to be the finest of its kind obtainable, and would urge anyone wishing to study Radio seriously to take your Course." George W. Elliott, 521 Elwyn St., Nelson, C., Canada.



**"MADE OVER \$300 NET IN SIX MONTHS"**

"While I have not hung out my 'shingle' yet, I have made over \$300 net in the past six months, doing some full and some part time Radio servicing. I am completely satisfied in every way with your Course, and I am mighty glad I signed on the 'dotted line,' making me a student of the Sprayberry Academy of Radio." Wendell M. Caldwell, 93 Hickory St., Rochester, N. Y.



### Cash In on Radio's Rich Opportunities

No matter if you desire to BE YOUR OWN BOSS in your own business or to land down a good job in Radio, my Training will give you the useful information and knowledge to win success. Days of delay mean precious time wasted. Start training for a money-making Radio career—right now.



**No Previous Experience Needed**

It makes no difference what your education has been. I can fit you quickly for a good-paying Radio job. I make it easy for you to grasp Radio principles and remember them. Your success is my full responsibility.

**EARN WHILE YOU LEARN**

My BUSINESS BUILDERS show you how to put your equipment to actual use in handling money-making Radio Service Jobs shortly after you begin training.

**Learn More About the SPRAYBERRY Method And How Easy It Is to Start**  
The complete details of my fundamental Course and Advanced Training Course . . . all features are fully described in my new, valuable 52-page FREE Book. Send for your copy. No obligation.

All Equipment Becomes Your Personal Property

## DON'T DELAY! ACT NOW

SPRAYBERRY ACADEMY OF RADIO

F. L. Sprayberry, Pres.  
420-B University Place, N. W.  
Washington, D. C.

Please send my FREE copy of "HOW TO MAKE MONEY IN RADIO"

Name ..... Age .....

Address .....

City ..... State .....

Tear off this coupon, mail in envelope or paste on penny postcard.

USE THIS COUPON for BIG **FREE BOOK** . . . GIVING COMPLETE FACTS

Clear the Track  
for a NEW RADIOLA

..here comes the

515!



2-BAND AMERICAN  
AND FOREIGN RECEPTION  
plus all these features

**\$24.95** EASTERN LIST PRICE

Wrap-Around Cabinet of Costly Woods  
2 Built-in Loops: Long Waves and Short  
Big, Modern, Easy-Reading Horizontal  
Dial  
R-F Stage—Phonograph Jack & Switch  
Positive A.V.C. Action—Tone Control

Equipped Exclusively with RCA Preferred Type Tubes

For Speedy Sales by **SERVICEMEN**

—6 TUBES WITH R-F STAGE

It's a fast-moving, super-powered express to profits unlimited, this new Radiola 515! Sales-slanted . . . feature-filled . . . designed and manufactured for *servicemen* to sell!

It's the latest addition to the great new line that's backed by a grand old name . . . RADIOLA—the line that has already put thousands of dollars in servicemen's pockets all over the country. The new 515 has all the money-making

features of the other Radiolas—and *more*. Foreign reception. *Two* built-in Antennas. 6 RCA Preferred Type Tubes. A stage of R-F amplification ahead of the sensitive superheterodyne circuit for extra sensitivity and higher signal-to-noise ratio.

Designed to sell on performance, it's *built* to perform . . . and how! See it—hear it—at your Radiola Distributor's, and you'll agree: "For profits, ride the 515 to town!"



**Radiola** Preferred Type Radios

Made by RCA Manufacturing Company, Inc., Camden, N. J., U. S. A.  
A Service of the Radio Corporation of America